



STAINLESS STEEL HINGED DOOR STYLE ENCLOSED BASE WORK TABLES



Flat Top



1 1/2" Backsplash



5" Backsplash



FEATURING BOLT-ON
STAINLESS STEEL LEG

Item #: _____ Qty #: _____
 Model #: _____
 Project #: _____

FEATURES:

FLAT TOP is furnished with a 1 5/8" sanitary rolled rim on the front and 1 5/8" square bend edges on the 2 sides and rear.

1 1/2" SPLASH is furnished with a 1 5/8" sanitary rolled rim on the front side and 1 5/8" square bend edges on the 2 sides and a 1 1/2" splash of single metal thickness on the rear side.

5" SPLASH is furnished with a 1 5/8" sanitary rolled rim on the front side and 1 5/8" square bend edges on the 2 sides and a 5" splash with a 1" return on the rear side.

HINGED DOORS are constructed as double panel doors with recessed inner panels for extra rigidity.

Rear flush panel along the rear of the base unit.

CONSTRUCTION:

All TIG welded. Exposed areas finished to match adjacent surfaces. Entire Top is mechanically polished to a satin finish and is sound deadened.

Hat section secured to Top reinforces and maintains level working surface.

UNI-BODY DESIGN sides, back and fixed mid shelf (sold separately) are welded to form a single rigid structure.

Legs bolt on to table base.

MATERIAL:

TOP is 14 gauge stainless steel type "304" series with galvanized understructure.

BODY is 18 gauge stainless steel type "430" series.

LEGS are stainless steel and include 1 1/2" adjustable hex foot.

	L	FLAT TOP	1 1/2" SPLASH	5" SPLASH	# of Doors	Approx. Wt.	Approx. Cu. Ft.
24" WIDE	36"	HB-SS-243	HF-SS-243	HK-SS-243	2	160 lbs.	30
	48"	HB-SS-244	HF-SS-244	HK-SS-244	2	195 lbs.	38
	60"	HB-SS-245	HF-SS-245	HK-SS-245	2	230 lbs.	47
	72"	HB-SS-246	HF-SS-246	HK-SS-246	4	280 lbs.	56
	84"	HB-SS-247	HF-SS-247	HK-SS-247	4	330 lbs.	66
	96"	HB-SS-248	HF-SS-248	HK-SS-248	4	370 lbs.	74
	108"	HB-SS-249	HF-SS-249	HK-SS-249	4	405 lbs.	83
30" WIDE	120"	HB-SS-2410	HF-SS-2410	HK-SS-2410	4	445 lbs.	92
	144"	HB-SS-2412	HF-SS-2412	HK-SS-2412	6	550 lbs.	109
	36"	HB-SS-303	HF-SS-303	HK-SS-303	2	175 lbs.	35
	48"	HB-SS-304	HF-SS-304	HK-SS-304	2	215 lbs.	45
	60"	HB-SS-305	HF-SS-305	HK-SS-305	2	255 lbs.	55
	72"	HB-SS-306	HF-SS-306	HK-SS-306	4	315 lbs.	66
	84"	HB-SS-307	HF-SS-307	HK-SS-307	4	360 lbs.	76
36" WIDE	96"	HB-SS-308	HF-SS-308	HK-SS-308	4	405 lbs.	87
	108"	HB-SS-309	HF-SS-309	HK-SS-309	4	430 lbs.	97
	120"	HB-SS-3010	HF-SS-3010	HK-SS-3010	4	485 lbs.	107
	144"	HB-SS-3012	HF-SS-3012	HK-SS-3012	6	580 lbs.	128
	36"	HB-SS-363	HF-SS-363	HK-SS-363	2	188 lbs.	41
	48"	HB-SS-364	HF-SS-364	HK-SS-364	2	235 lbs.	53
	60"	HB-SS-365	HF-SS-365	HK-SS-365	2	275 lbs.	65
36" WIDE	72"	HB-SS-366	HF-SS-366	HK-SS-366	4	335 lbs.	77
	84"	HB-SS-367	HF-SS-367	HK-SS-367	4	383 lbs.	90
	96"	HB-SS-368	HF-SS-368	HK-SS-368	4	420 lbs.	102
	108"	HB-SS-369	HF-SS-369	HK-SS-369	4	450 lbs.	114
	120"	HB-SS-3610	HF-SS-3610	HK-SS-3610	4	510 lbs.	126
	144"	HB-SS-3612	HF-SS-3612	HK-SS-3612	6	615 lbs.	151

Mid Shelves Are Available.

To Add a Fixed Mid Shelf, Add "M" After each Model Number.

Upgrade to Adjustable Mid Shelf. Add TA-116.



Customer Service Available To Assist You 1-800-645-3166 8:30 am - 8:00 pm E.S.T.

For Orders & Customer Service:

Email: customer@advancetabco.com or Fax: 631-242-6900

For Smart Fabrication™ Quotes:

Email: smartfab@advancetabco.com or Fax: 631-586-2933

DETAILS and SPECIFICATIONS

TOL ± .500"

Units 7' and larger are furnished with 6 legs.

ALL DIMENSIONS ARE TYPICAL

HB-Series Flat Top

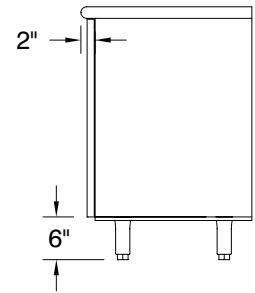
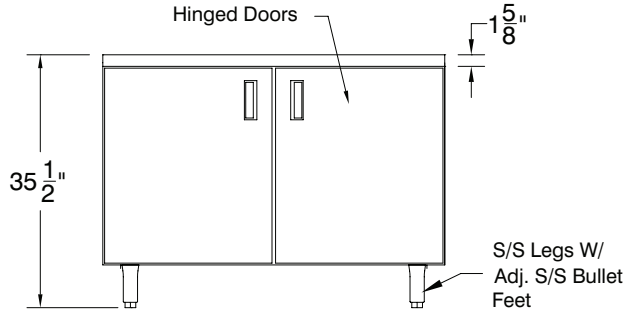
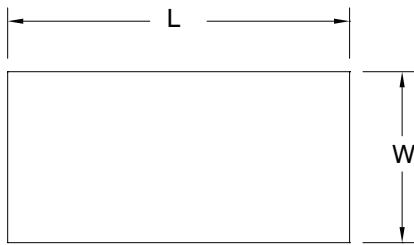

HF-Series 1 1/2" Rear Splash

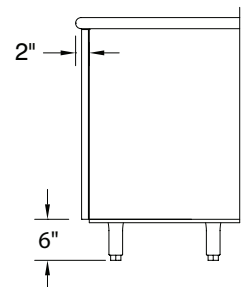
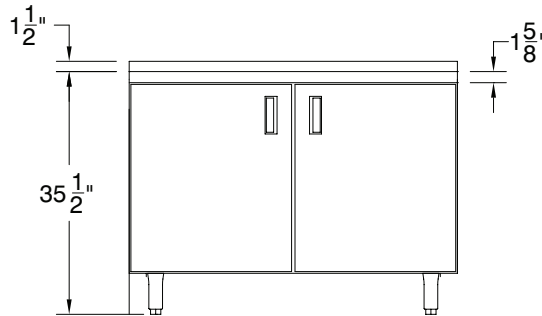
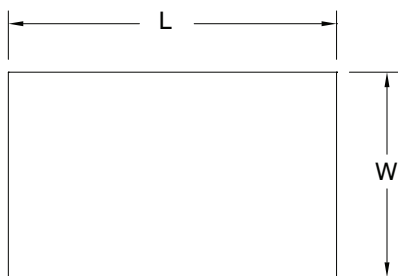

HK-Series 5" Rear Splash

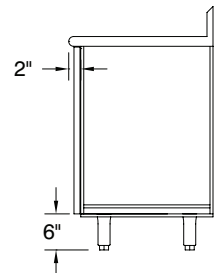
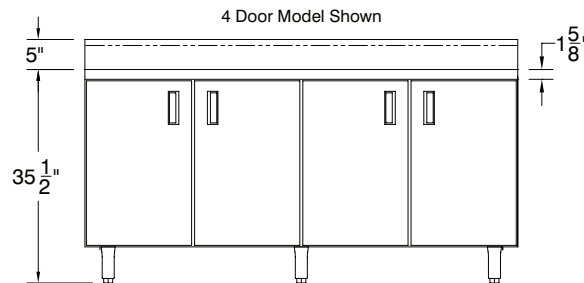
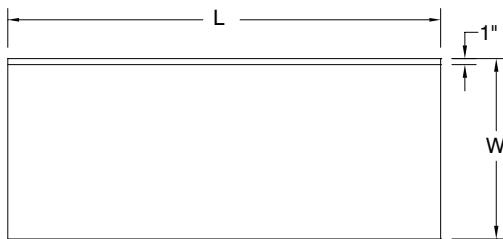

OPTIONAL MID SHELF DETAILS

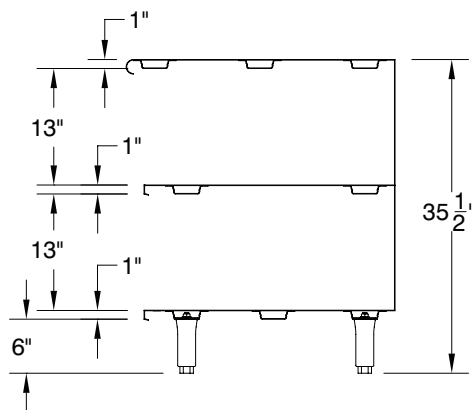

OPTIONAL ENCLOSED BASE ACCESSORIES

- TA-20L Replacement Bolt-on Leg
- TA-19L Replacement Bolt-on Leg
With Flanged Bullet Foot
- TA-255P 5" Heavy Duty Polyurethane Casters
(set of 4 - 2 w/ Brakes)
- TA-255AP.... 5" Heavy Duty Polyurethane Casters
(set of 6 - 2 w/ Brakes)
- TA-46 Door Locks
- TA-54 Removable Kick Plate

TA-116 ADJUSTABLE ENCLOSED BASE CABINET MID SHELF (Sold Separately)

Shelves Over 36" In Length Require Multiple Sections With Center Partition.

