



Technical Data

**MIRROR WITH
STAINLESS STEEL
ANGLE FRAME
AND SHELF**

**B-292
SERIES**



Designer's Notes:

1. Special-order sizes available on request.
2. Maximum size one-piece angle-frame mirror, 96" x 72" (244 x 183cm); minimum size, 12" x 12" (30 x 30cm).
3. All Bobrick framed mirror/shelf models are manufactured to overall width and height dimensions of mirror, not including shelf. EXAMPLE: For Lock Tab Design B-292 2436 (61 x 95cm) mirror will be furnished 24" x 37-1/4" (61 x 94cm) outside-of-frame to outside-of-frame including shelf.
4. To specify special sizes use Series Number followed by width then height in inches. EXAMPLE: B-292 2024.
5. Bobrick framed mirror/shelf models are manufactured to a tolerance $\pm 1/8"$ (3.2mm).
6. For sufficient space to lift mirror onto wall hanger(s), provide 1" (25mm) minimum clearance above top of mirror frame.
7. Provide 1" (25mm) minimum clearance at bottom of mirror for unlocking mirror from wall and 1/2" (12.7mm) clearance on each side.

**Snap Locking Design
(Rear View)**

Figure: 1

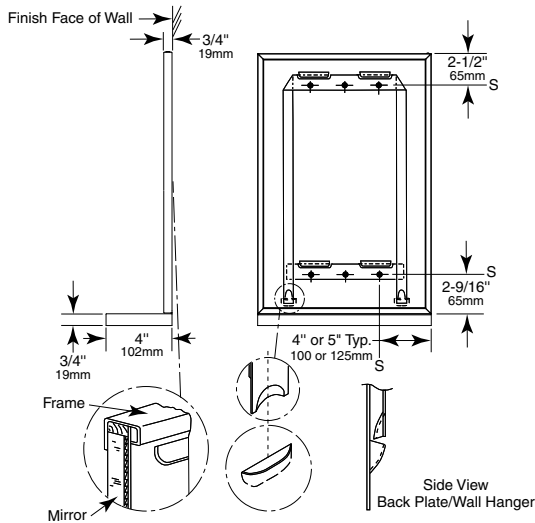

**Lock Tab Design
(Rear View)**

Figure: 2

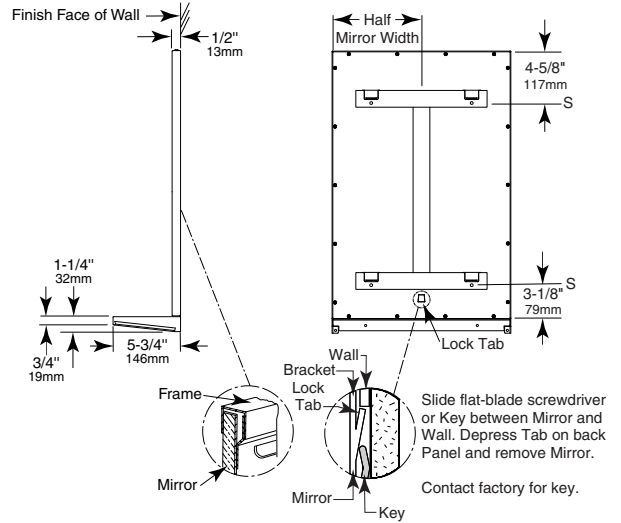

STANDARD B-292 SERIES MIRRORS

MODEL NO.	OVERALL SIZE	
	W	H
B-292 1830	18" (46cm)	30" (76cm)
B-292 1836	18" (46cm)	36" (91cm)
B-292 2436	24" (61cm)	36" (91cm)

All Other Size Mirrors

Note: Mirrors greater than 30" in width will have multiple hanger brackets with a typical 8" off each edge.

Width	Hangers
Up to 30" (Up to 76cm)	1
31" to 41" (78 to 104cm)	2
42" to 72" (106 to 183cm)	3
73" to 91" (185 to 231cm)	4
92" to 96" (233 to 249cm)	5

continued . . .

MATERIALS:

Frame — 18-8, type 304, heavy-gauge stainless steel, 3/4" x 3/4" (19 x 19mm) angle with satin finish. One-piece, roll-formed construction forms continuous integral stiffener on all sides. Bevel design on front of angle holds frame tightly against mirror. Corners of mirror frame are heliarc welded, ground, and polished smooth. Galvanized steel back is fastened to frame with concealed screws and equipped with integral horizontal hanging brackets near the top for hanging the mirror and near the bottom to prevent the mirror from pulling away from the wall. Locking devices secure mirror to concealed wall hanger.

Shelf — 18-8, type 304, 18-gauge (1.2mm) stainless steel with satin finish, 3/4" (19mm) return edge on front. Front and side return edges hemmed for additional strength and safety. Front corners of shelf are welded, ground, and polished smooth. Shelf is welded to mirror frame. No exposed rivet-heads, screws, or fasteners of any type on frame or shelf.

Mirror — No. 1 quality, 1/4" (6mm) select float glass (standard glass): selected for silvering, electrolytically copper-plated by the galvanic process, and guaranteed for 15 years against silver spoilage. All edges protected by plastic filler strips; back is protected by full-size, shock-absorbing, water-resistant, nonabrasive, 3/16" (5mm) thick polyethylene padding.

Concealed Wall Hanger — Galvanized steel construction. Incorporates upper and lower support members, which engage backplate louvers to keep mirror against wall.

INSTALLATION:

Mount wall hanger on wall with screws (not furnished) at points indicated by an S. For plaster or dry wall construction, provide backing to comply with local building codes, then secure wall hanger with screws (not furnished). When providing a concealed backing, allow backing to cover minimum range of mounting hole locations shown on drawing. For other wall surfaces, provide fiber plugs or expansion shields for use with screws (not furnished), or provide 1/8" (3mm) toggle bolts or expansion bolts. Hang mirror on wall hanger with all four backplate louvers engaged behind horizontal wall hanger members. To do this, mirror must be centered in front of the wall hanger horizontally, pressed flat against the wall approximately 1" (25mm) above final position and then lowered into final position.

Snap Locking Design — Locking devices automatically secure mirror to concealed wall hanger when it is lowered into final position (see figure 3). Locking devices may be unlocked by inserting two flat blade screwdrivers behind each side of mirror near the bottom or under the bottom of the mirror and pulling mirror bottom forward and then up.

Lock Tab Design — Locking devices automatically secure mirror to concealed wall hanger when it is lowered into final position (see figure 4). Locking device may be unlocked by sliding a flat-blade screwdriver or Key between mirror and wall at center of mirror and depressing tab on back panel. If key is required, please contact the factory.

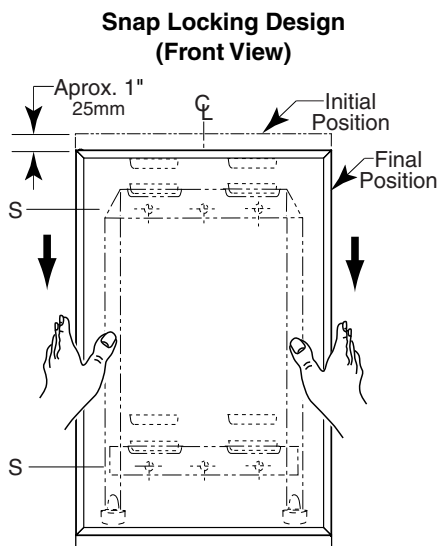

Figure: 3

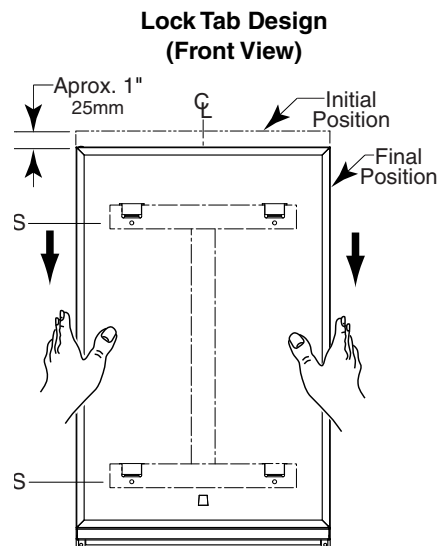

Figure: 4

SPECIFICATION:

Mirror shall have a one-piece, type 304 stainless steel angle frame, 3/4" x 3/4" (19 x 19mm) with continuous integral stiffener on all sides and beveled front to hold frame tightly against mirror; corners shall be heliarc welded, ground, and polished smooth; all exposed surfaces shall have satin finish. Shelf shall be type 304, 18-gauge (0.8mm) stainless steel with satin finish. Shelf shall have a 3/4" (19mm) return edge on front. Front and side return edges hemmed and corners welded, ground, and polished smooth. Shelf shall be welded to mirror frame. No rivet-heads, screws, or fasteners of any type shall be exposed on frame or shelf. Select float glass mirror shall be guaranteed for 15 years against silver spoilage. All edges shall be protected by plastic filler strips and the back shall be protected by full-size, shock-absorbing, water-resistant, nonabrasive, 3/16" (5mm) thick polyethylene padding. Galvanized steel back shall have integral horizontal hanging brackets located at top and bottom for mounting on concealed wall hanger and to prevent the bottom of the mirror from pulling away from the wall. Locking devices secure mirror to concealed wall hanger. Mirror shall be removable from wall hanger for reglazing mirror.

Framed Mirror With Shelf shall be Model B-292 _____ (insert width and height) of Bobrick Washroom Equipment, Inc., Clifton Park, New York; Jackson, Tennessee; Los Angeles, California; Bobrick Washroom Equipment Company, Scarborough, Ontario; Bobrick Washroom Equipment Pty. Ltd., Australia; and Bobrick Washroom Equipment Limited, United Kingdom.