

# 18" STAINLESS STEEL BAR DRAINBOARD

ITEM #: \_\_\_\_\_ QUANTITY: \_\_\_\_\_

PROJECT: \_\_\_\_\_

APPROVAL: \_\_\_\_\_

DATE: \_\_\_\_\_



**REGENCY**  
Tables and Sinks

## FEATURES

- Durable stainless steel construction; galvanized legs with bullet feet
- Adjustable front-to-back cross-bracings for stability
- Galvanized steel legs with stainless steel socket and plastic bullet feet
- Drain and backsplash reduce potential for wet, slippery surfaces
- 1" IPS drain



## SPECIFICATIONS

ITEM	LENGTH	WIDTH	HEIGHT	BACKSPLASH HEIGHT	WORK SURFACE HEIGHT
600DBU1812	12"	18"	34"	4"	30"
600DBU1818	18"	18"	34"	4"	30"
600DBU1824	24"	18"	34"	4"	30"
600DBU1830	30"	18"	34"	4"	30"
600DBU1836	36"	18"	34"	4"	30"
600DBU1848	48"	18"	34"	4"	30"

# 18" STAINLESS STEEL BAR DRAINBOARD



600DBU1812 • 12" x 18" X 34"

## FRONT

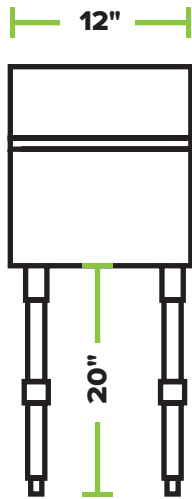

## SIDE

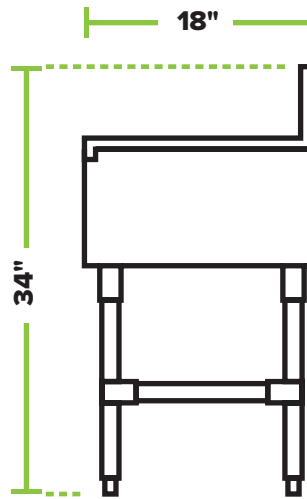

## TOP

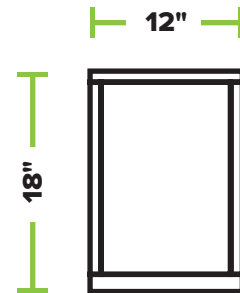

600DBU1818 • 18" x 18" X 34"

## FRONT

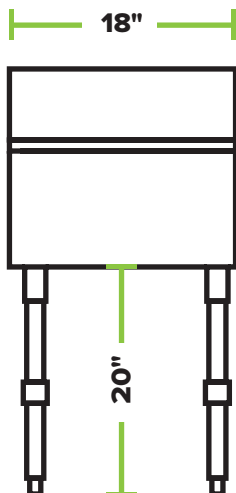

## SIDE

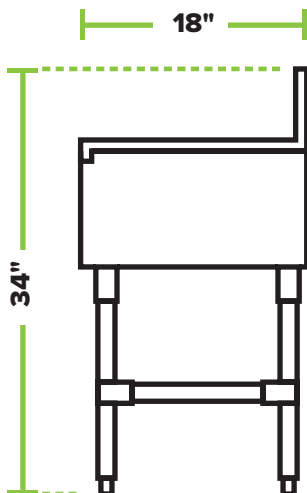

## TOP

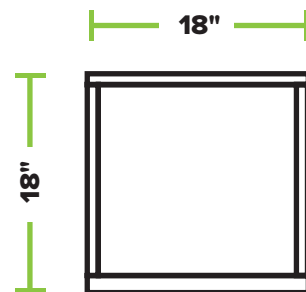

# 18" STAINLESS STEEL BAR DRAINBOARD



600DBU1824 • 24" x 18" X 34"

## FRONT

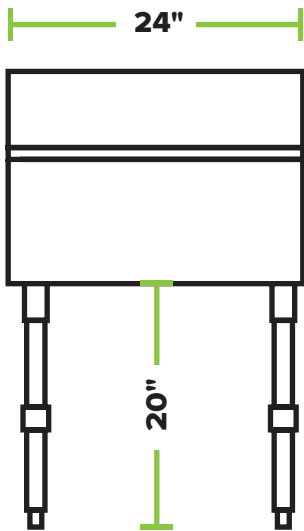

## SIDE

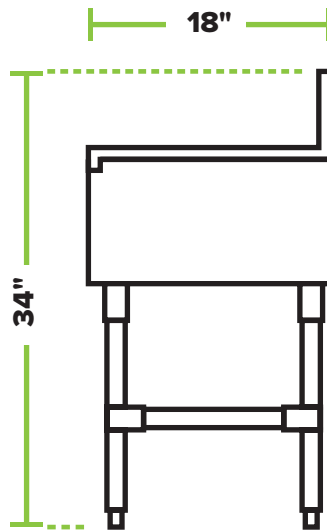

## TOP

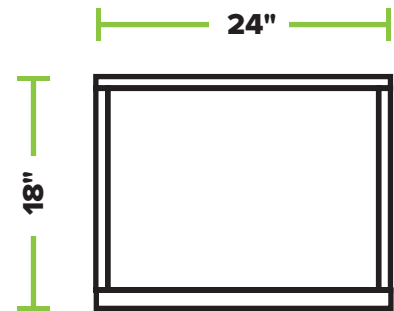

600DBU1818 • 30" x 18" X 34"

## FRONT

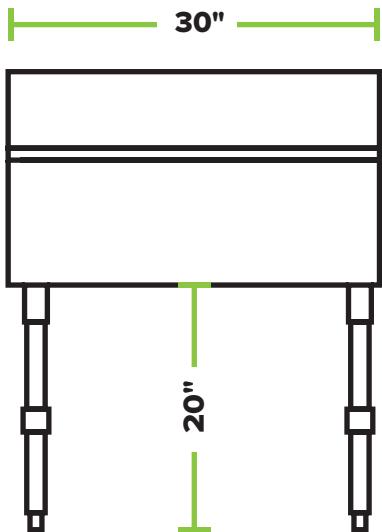

## SIDE

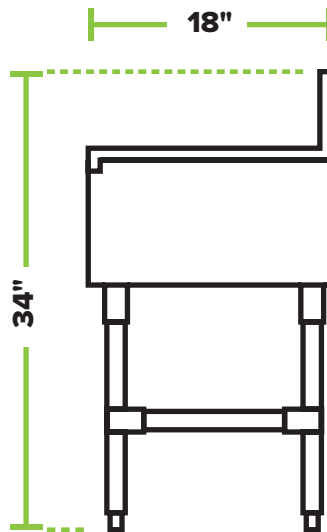

## TOP

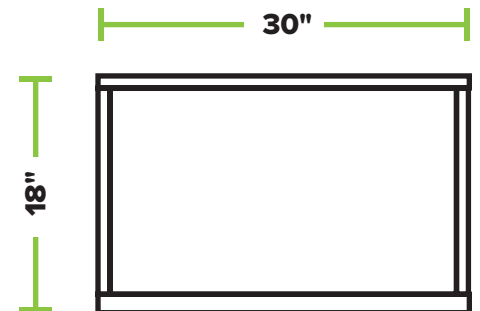

# 18" STAINLESS STEEL BAR DRAINBOARD



600DBU1836 • 36" x 18" X 34"

FRONT

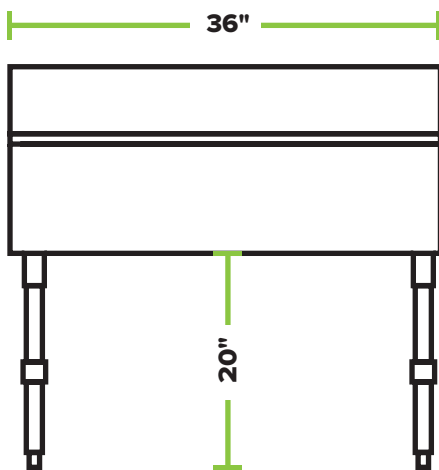

SIDE

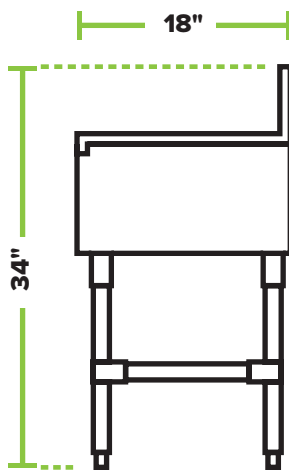

TOP

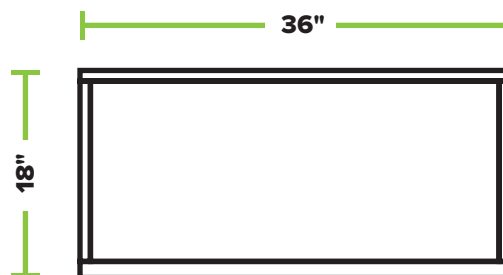

600DBU1848 • 48" x 18" X 34"

FRONT

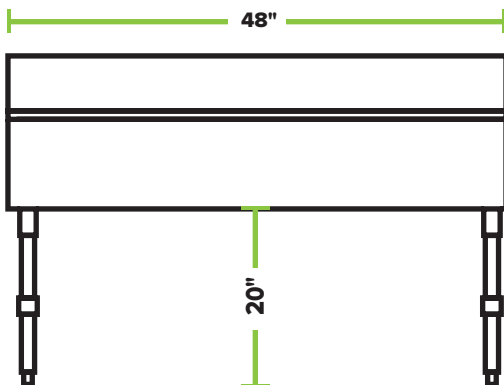

SIDE

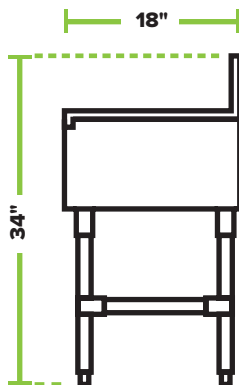

TOP

