

SOLWAVE

Item #: 180MW2100T

Commercial Microwave with push buttons

208/240V 2100W



Features

- Large 1.2 cu. ft. stainless steel cavity allows for plates up to 14" in diameter
- Sleek stainless steel exterior
- Four power levels, 3 stages of cooking and 100 programmable menu settings for ultimate user customization and consistency
- Dual magnetrons for even heat distribution
- Motor driven double rotating antenna provides efficient energy distribution
- Stackable to save on space
- One touch time options that can be set from 10 seconds to 3.5 minutes
- 60 second automatic cool down feature
- 1 year warranty on parts and labor
- 3 year warranty on the magnetrons



SOLWAVE

Item #: 180MW2100T

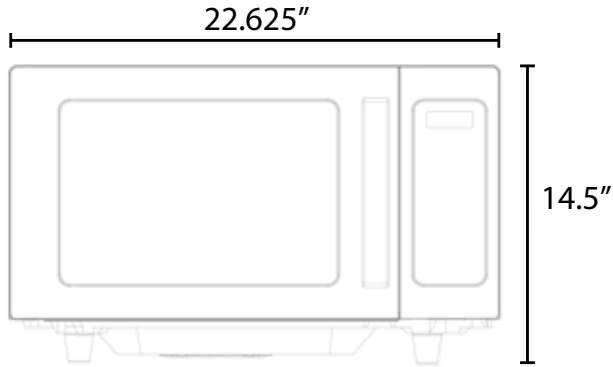

FRONT

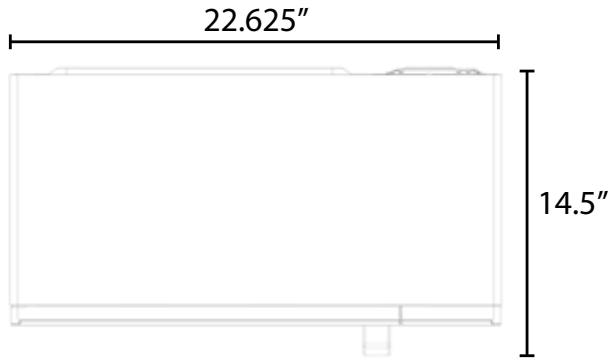

BACK

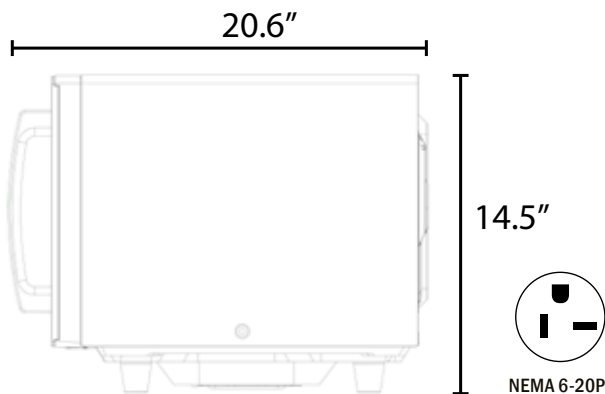

SIDE

Specifications

Controls	Touchpad
Programmable Settings	100
Power Levels	4
Display	LED
Magnetrons	2
Cooking Stages	3

Dimensions

Capacity	1.2 cu. ft.
Unit Dimensions	22.63"W x 14.5"H x 20.6"D
Oven Cavity Dimensions	14.19" W x 16.06" D x 8.81" H
Shipping Weight	74 lbs.
Product Weight	64 lbs.

Electrical

Voltage	208/240V
Hz	60 Hz
Wattage	2100W
Usage Level	Medium Duty

