



# INSTRUCTIONS FOR OPERATION AND CARE

## XVSGH GRATER/SHREDDER HOUSING AND ATTACHMENTS



Our versatile grater/shredder attachments can be used to grate and shred cheeses, raw vegetables, nuts, breadcrumbs, etc. depending on the plate or disc selected. Our S/S discs are available with 3/32", 3/16", 1/4", 5/16", or 1/2" size holes and a special grating disc for breadcrumbs & hard cheeses is available.



**XVSGH**

Our slicer attachments can be used for slicing potatoes (from 1/16" to 5/8" thickness); cutting vegetables for salads and coleslaw; or for slicing fruits and nuts.

### WARNING

Serious injury can result if this product is used improperly. Proper training is important to prevent injury. It is important to read the manual completely prior to use. Never put your hand or fingers inside the hopper. Sharp knife will cause serious injury. Only trained and qualified persons 18 years and older should use these attachments.

The XVSGH is made up of the following three basic components:

1. XVSH Housing
  2. XVSD Door or Hopper
  3. XVSP Pusher Plate
- Plate Holder or Adjustable Slicer Plate units
- XASP Adjustable Slicer Shaft with S/S "S" knife
  - XPH Plate Holder with Shaft

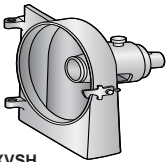

1. XVSH

#### HOUSING OR BACK CASE

The housing or back case mounts into the attachment socket of a mixer, food cutter or power drive unit. The housing is held on with the pointed thumbscrew that goes through the attachment hole into the indentation on neck of the machine.

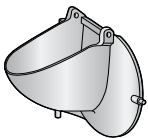

2. XVSD

#### HOPPER

The door is a hopper and lever feed design. It hinges onto the back case and is held closed with an adjustable latch. To remove door, lift latch and swing door open while lifting it from the hinge holes.

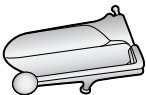

3. XVSP

#### PUSHER PLATE

The pusher plate has an integrated handle to push the food into the rotating disc or slicer knife. It has pins at both sides of the top and hinges into door. The pusher plate has a rubber-tipped stop screw under the handle that can be adjusted to prevent the pusher plate from coming in contact with the disc or blade.



XASP

#### ADJUSTABLE SLICER PLATE WITH STAINLESS STEEL "S" KNIFE AND SHAFT

Stainless steel "S" knife is ideal for slicing vegetables.



XPH

#### PLATE HOLDER WITH SHAFT

Shredder discs are available with 3/32", 3/16", 1/4", 5/16", or 1/2" hole sizes. These plates have keyhole slots for attaching to shouldered studs on the plate hubs.

## TO INSTALL SHREDDER OR GRATER DISCS

Stop the machine. Point disc with cutting edge away from shaft assembly. Engage keyhole slots on plate and slide the wide part of keyhole slots over studs on plate holder. When plate is flush with plate holder, rotate it clockwise to lock it in position. It is possible to loosely assemble the disc to hub (sharp edge out), then put it on a work surface (the "teeth" on plate will mar a finished table). Press down and turn hub until plate locks into position. The sharp "teeth" must face out on plate holder. To detach plate from hub, reverse the installation procedure. A safe method is to use protective gloves and press the palm of one hand against the disc to rotate it.

**Note:** The discs are slightly bent to supply holding pressure when in position.

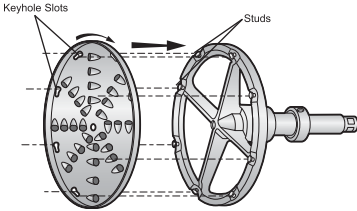

## SHREDDER DISC

The coarse plates are normally used for making chopped slaw, cutting vegetables for soup stock, salad blends or "hash brown" potatoes. The medium and finer plates are for fine shredding of carrots, beets, turnips, etc., and for salads. See our application chart at the end of these instructions.

## GRATER DISC

The grater plates can be used for crumbling hard cheese or grating hard vegetables.

## TO INSTALL PLATE HOLDER ASSEMBLY

Stop the machine. With door open, pull locking pin up and put plate holder assembly in until the square end of shaft fits snugly into power unit. Release locking pin to hold plate holder assembly in correct position. Close door.

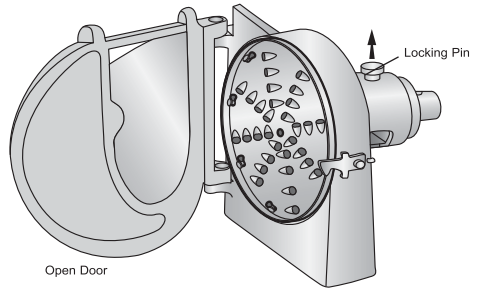

## ADJUSTABLE SLICER PLATE ASSEMBLY & INSTALLATION

Turn off and unplug the machine. Adjust the slicing thickness from approximately 1/16" to 5/8" by turning adjustment nut. Lift the locking pin on top of housing. Open door and slide adjustable slicer plate assembly back into operating position. The square end of shaft can be manually rotated to seat into machine socket correctly. Tighten adjustable slicer plate assembly to machine with locking pin on top of housing. Attach pusher plate and close door before turning on machine.

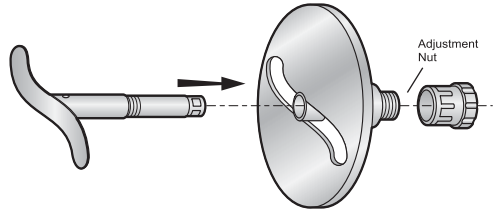

## TO ADJUST THICKNESS OF SLICES

Stop the machine. Remove adjustable slicer plate assembly from housing and turn adjustment nut while carefully holding adjustable slicer plate assembly.

**Note:** Thickness of slices can be adjusted with slicer plate assembly in position. Turn adjustment nut, accessed through the adjustment nut access in rear housing to adjust thickness of slices. Globe recommends that the adjustable slicer plate is removed to adjust slice thickness.

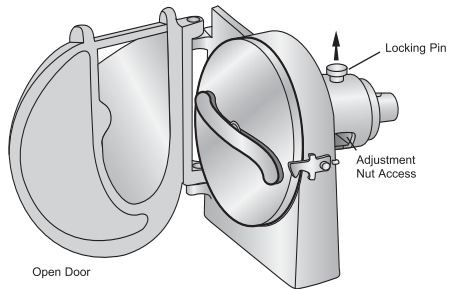

**Caution:** The adjustment nut turns with shaft. Adjustments must not be attempted unless the unit is turned off and unplugged.

### TO REMOVE ADJUSTABLE SLICE PLATE ASSEMBLY FROM HOUSING

Open door and lift locking pin on top of housing. Pull adjustable slice plate assembly out.

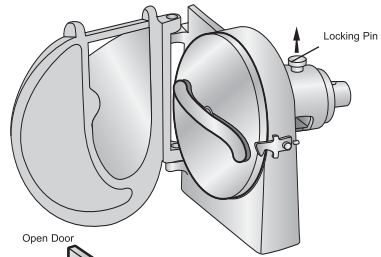

### TO REMOVE ATTACHMENT FROM POWER UNIT

Loosen thumb screw on power unit until hub is free for removal from unit.

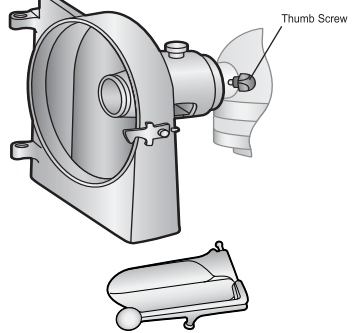

### PUSHER PLATE REMOVAL

Raise pusher plate and slide out of slot in door.

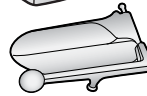

## OPERATION

1. Stop power unit (mixer, food cutter, chopper, power drive etc.)
2. Attach housing of slicer to attachment socket of companion machine with thumb screw.

**Note:** There will be a gap between the housing and the mixer hub.

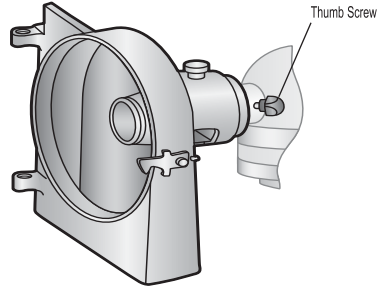

3. Select grater/shredder or slicer assembly to be used. Lift locking pin and put plate and shaft assembly into drive position. Release locking pin.

Set adjustable slicer plate (if used) to the proper thickness.

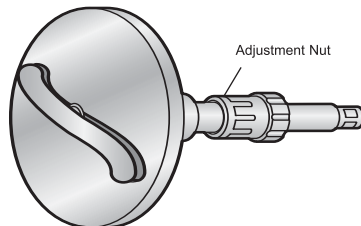
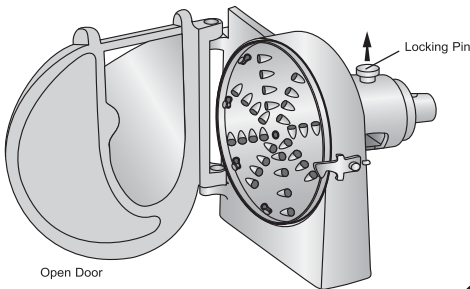

4. Drop hinge pins of door into holes in housing.

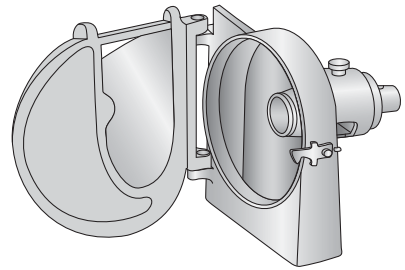
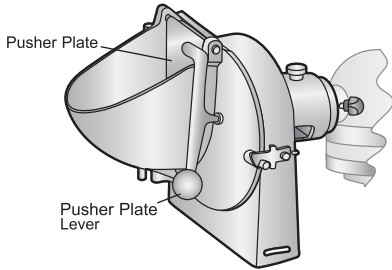

5. Close door and fasten latch.

6. Start the machine. Set at a speed to produce the best product (see machine manual).

7. Raise pusher plate lever.

8. Put food to be sliced in hopper and gently press down on pusher plate lever.

**WARNING:** Keep Hands out of Hopper — use a stomper or pusher plate.

**Note:** Too much pressure can crush the food and cause irregularity in slices. Large items can be cut down to fit into hopper.

#### MAINTENANCE INSTRUCTIONS

##### CLEANING

1. Stop power unit (mixer, food cutter, power drive, etc.).
2. Release latch and remove door.
3. Lift locking pin and remove shredding or slicing unit from housing.

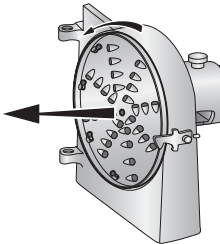
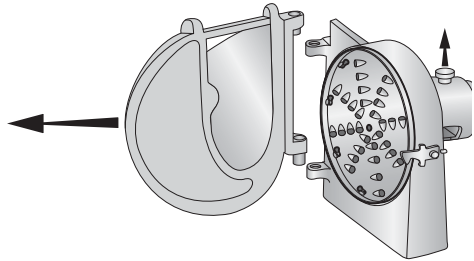

4. Shredder and grater discs can be easily removed from plate hub by rotating plate counter-clockwise to release keyhole slots from studs.

**WARNING:** Discs are sharp and must be handled with care.

5. All components of attachments can be cleaned by **HAND WASHING ONLY**, using mild detergent in warm water. Units are **NOT** dishwasher safe due to the corrosive nature of commercial detergents, which can discolor aluminum and turn it black. Rinse in hot, clear water and dry immediately. It is important that juices be cleaned from the attachments before they dry.

Note: Frequent lubrication with a USDA approved grease is necessary to prevent shaft seizing.

6. When using the adjustable slicer plate, make sure it is cleaned frequently to assure easy thickness adjustment. Occasionally disassemble the adjustable slicer plate for a thorough cleaning. To do this it is necessary to unscrew knurled thrust bearing, which has a left hand thread, to release the spring. Remove knife and shaft assembly. Unscrew adjustment nut from adjustable slicer plate. Use a drop of approved food machinery oil on shaft and adjustment threads after cleaning.

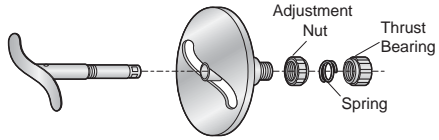

Note: To prevent damage after cleaning thrust bearing must be tightened until sealed against shoulder on shaft. Failure to properly reassemble can result in damage to knives, shaft and adjustable slicer plate. Do not clean components in dishwasher with strong detergents or chemicals. Use a USDA approved grease on shaft for best operation.

**CAUTION:** Do not allow water or moisture to remain on or in hub, shaft, or rear opening in the housing. This condition will result in rusting which after some time can destroy the rear end components and shaft and void the 1 year factory warranty.

### KNIFE SHARPENING

Occasional touching up along the edges of knife with a honing stone will keep cutting operations at peak performance.

### PUSHER PLATE STOP

Frequently check that the pusher plate does not hit grater plate holder or knife shaft assembly. The pusher plate stop screw can be adjusted to avoid touching the internal moving parts. With proper care and maintenance, your Vegetable Grater/Shredder/Slicer Attachment will provide many years of performance.

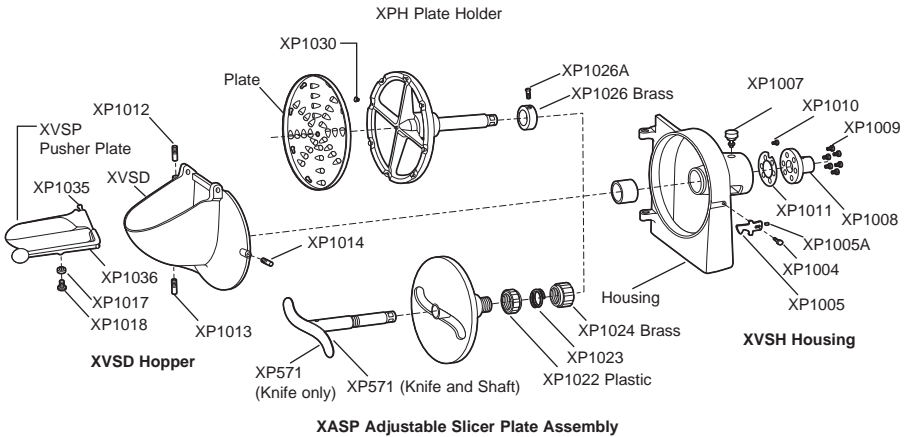

**WARNING**

**KEEP FINGERS AND HANDS  
AWAY FROM MOVING PARTS**

## PART NUMBER LISTING

### XVSH HOUSING

XVSH	Housing size 12
XP1004	Threaded (Hex) Pin for housing latch
XP1005	Latch with set screw
XP1005A	Latch set screw only
XP1007	Locking Pin
XP1008	Housing Hub with locating pin - six holes
XP1009	Flat Head Machine Screw (6) for hub
XP1010	Knife Lock Screw
XP1011	Fiber gasket

### XPH PLATE HOLDER

XPH	Plate Holder Assembly Complete
XP1026	Brass Collar with set screw
XP1026A	Set Screw for Collar
XP1030	Stud for Plate Holders
XSP332	3/32" S/S Shredder Plate
XSP316	3/16" S/S Shredder Plate
XSP14	1/4" S/S Shredder Plate
XSP516	5/16" S/S Shredder Plate
XGP	S/S Grater Plate

### XASP ADJUSTABLE SLICER PLATE

XP571	"S" Knife Only
XP1571	"S" Knife and Shaft-Assembly
XP1022	Adjustment Nut
XP1023	Tension Spring
XP1024	Brass Lock Nut or Thrust Bearing

### XVSD HOPPER

XP1012	Upper Hinge Pin (long)
XP1013	Lower Hinge Pin (short)
XP1014	Latch Pin

### XVSP PUSHER PLATE

XP1017	Stop Nut
XP1018	Stop Screw
XP1035	Round Hinge Pin
XP1036	Bullet Hinge Pin

## Shredder and Grater Plate Hole Sizes with Typical Applications

Food Product	1/2" Shredder Plate 000	5/16" Shredder Plate 0	3/16" Shredder Plate 3	3/32" Shredder Plate 7	Universal Grater Plate 14
Cole Slaw	●	●			
Bread Crumbs		●			●
Cheese		●			
Soft Cheese For Pizza			●		
Carrots For Coloring			●	●	
Cheese For Tacos				●	
Hard Cheese					●

Stainless steel Shredder Disc hole sizes (not drawn to scale)

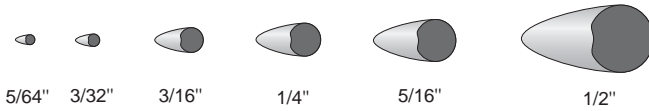

SS Grater Disc



For Hard  
Cheese only



## WARNING

**KEEP FINGERS AND HANDS  
AWAY FROM MOVING PARTS**

LIMITED WARRANTY: Globe Food Equipment Company (“GFE”) warrants to the original purchaser of new equipment that said equipment, when installed in accordance with our instructions within North America and subjected to normal use, is free from defects in material or workmanship for a period of 1 year from invoice date. The XVSA Vegetable Slicing Attachment and XVGA Shredder/Grate Attachment have a 1 year replacement warranty. There is no labor warranty for mixer attachments.

THIS WARRANTY IS IN LIEU OF ALL OTHER WARRANTIES, WHETHER EXPRESSED OR IMPLIED. GFE EXPRESSLY DISCLAIMS ANY IMPLIED WARRANTY OF MERCHANTABILITY OR EXPRESSED OR IMPLIED WARRANTY OF FITNESS FOR A PARTICULAR PURPOSE.

GFE’S OBLIGATION AND LIABILITY UNDER THIS WARRANTY IS EXPRESSLY LIMITED TO REPAIRING OR REPLACING EQUIPMENT WHICH PROVES TO BE DEFECTIVE IN MATERIAL OR WORKMANSHIP WITHIN THE APPLICABLE WARRANTY PERIOD. All repairs pursuant to this Warranty will be performed by GFE Service during normal working hours. IN NO EVENT SHALL GFE BE LIABLE FOR INCIDENTAL OR CONSEQUENTIAL DAMAGES TO BUYER OR ANY THIRD PARTY, INCLUDING, WITHOUT LIMITATION, LOSS OF PROPERTY, PERSONAL INJURY, LOSS OF BUSINESS OR PROFITS OR OTHER ECONOMIC LOSSES, OR STATUTORY OR EXEMPLARY DAMAGES, WHETHER IN NEGLIGENCE, WARRANTY, STRICT LIABILITY, OR OTHERWISE.

This warranty is given only to the first purchaser from a retail dealer. This warranty is not transferable or assignable to any subsequent owner.

This warranty does not cover product failures caused by: failure to maintain, neglect, abuse, damage due to excess water, fire, normal wear, improper set up and use. Periodic maintenance is not covered.

Example of items not covered under warranty, but not limited to just these items:

1. Acts of God, fire, water damage, vandalism, accident, theft.
2. Freight damage.
3. Improper installation or alteration of equipment.
4. Use of generic or after market parts.
5. Repairs made by anyone other than a GFE designated servicer, or not pre-authorized by GFE.
6. Lubrication.
7. Expendable wear parts - shredder/grater plates and “S” knife.
8. Cleaning of equipment.
9. Misuse or abuse.

Service under this warranty shall not be made available until such time as a properly completed, digitally signed Installation/Warranty Registration has been received by GFE within 30 days from the date of installation. Complete warranty registration at [www.globefoodequip.com/support/warranty-registration-form](http://www.globefoodequip.com/support/warranty-registration-form). Proof of purchase is required if extended more than 1 year from date of shipment from the factory

THE FOREGOING WARRANTY PROVISIONS ARE A COMPLETE AND EXCLUSIVE STATEMENT BETWEEN THE BUYER AND SELLER. GFE NEITHER ASSUMES NOR AUTHORIZES ANY PERSONS TO ASSUME FOR IT ANY OTHER OBLIGATION OR LIABILITY IN CONNECTION WITH SAID EQUIPMENT.

---

#### **FOR A DISTRIBUTOR NEAR YOU**

FOR COMPLETE XVSA, XVGA AND SHREDDER PLATE SALES  
TOLL FREE: 1-800-347-5423 FAX: 937-299-4147

FOR SPARE PARTS SALES:  
TOLL FREE: 1-800-745-6238 FAX: 937-290-0585

GLOBE FOOD EQUIPMENT COMPANY  
PO BOX 3209 DAYTON, OHIO 45439  
[www.globefoodequip.com](http://www.globefoodequip.com)