



HOW TO: FINISH FLOORS

TOOLS



18" Quick Connect Frame



18" MF Finish Pad • Q800



Quick Connect
Handle of
Choice



Safety Sign



MF Finish Bucket with Lid
and Floor Finish of Choice

TIPS

- Follow all established safety procedures.
- Wear all appropriate personal protective equipment (glasses, gloves, etc.).

PREPARATION

- Remove all furniture from room or corridor.
- Sweep all debris from floor.
- Place floor signs in all pedestrian walkways.
- Scrub or strip old finish from floor.
- Clean baseboards and corners of room.
- Microfiber dust mop area to be finished.

PROCEDURE

- 1** Set up floor safety sign. Affix Quick Connect mop handle to 18" frame.
- 2** Place a clean, dry Finish Pad on floor with white backing side up.
- 3** Hold Quick Connect Frame over pad, then slide it down to attach pad with hook and loop system.
- 4** Fill bucket to desired level with floor finish of choice. Do not overfill.
- 5** Place microfiber flat mop into bucket. Only submerge pad into finish. Do not submerge aluminum frame or universal joint.
- 6** Allow excess finish to drip into bucket, then tamp mop on sieve.
- 7** Starting at the far corner of room or end of hall, outline first area to be finished.
- 8** Using "Figure 8" strokes, fill in outlined area with a light coat of finish. Finish should be no thicker than a piece of wax paper. Foam pad liner helps to hold enough finish to cover outlined area.
- 9** Working backward, be sure to begin next area before finish dries to prevent lines and ridges.
- 10** Repeat steps 5 through 10 as required to complete the job.
- 11** To empty bucket into a container, use twist valve on backside or pour contents using one of the front corners as a pouring spout.
- 12** After emptying, rinse bucket and valve with hot water to prevent finish from hardening on sides and drain.
- 13** OPTION: To store finish in bucket for reuse, use air tight lid to prevent drying/hardening.
- 14** Clean pad well with hot water and hang to air dry or store in sealed plastic bag to prevent hardening.
- 15**
- 16**

OVER

HOW TO: Finish Floors

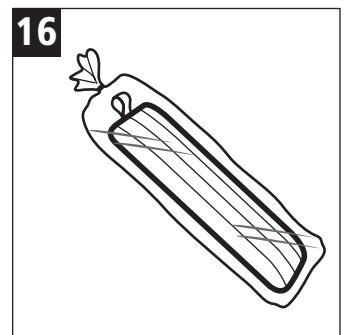
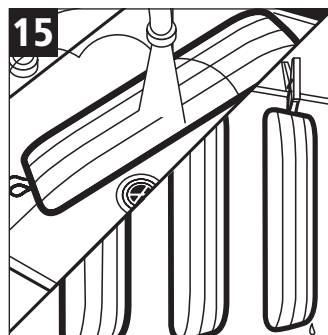
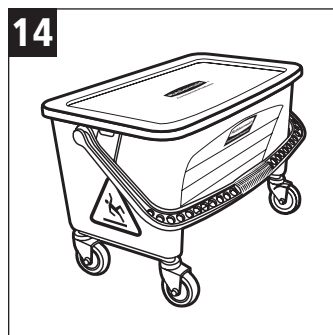
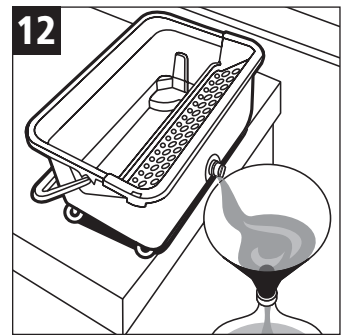
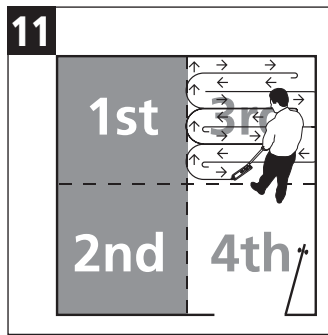
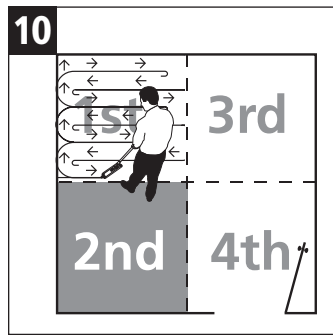
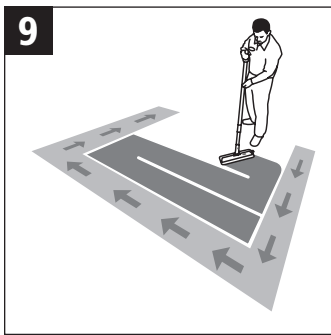
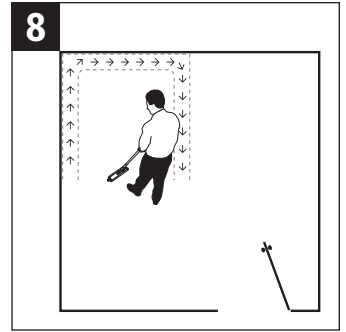
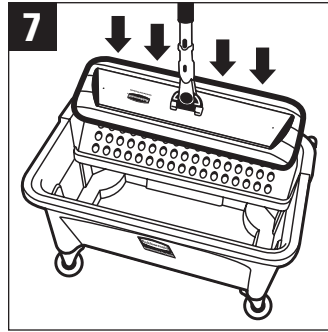
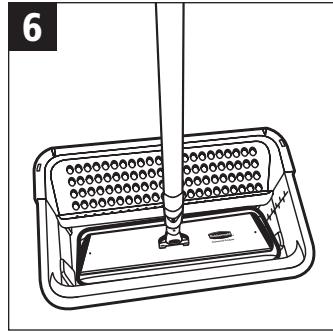
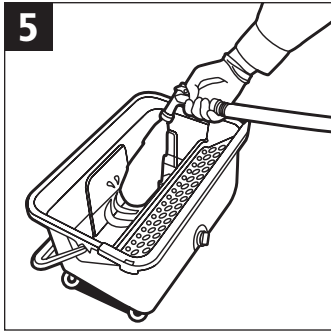
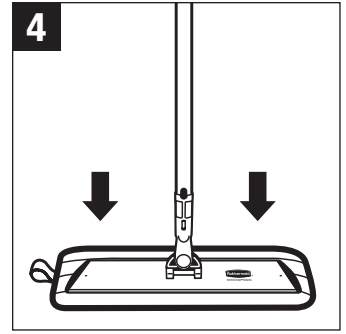
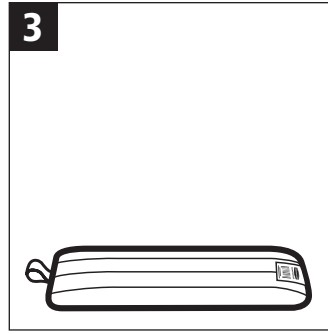
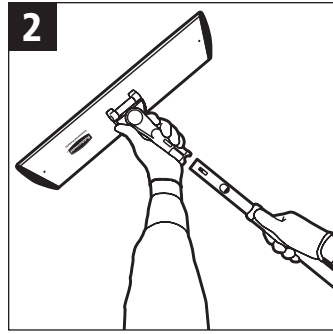
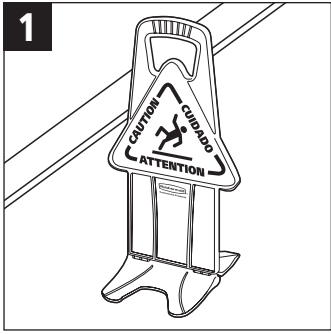

Customer Service: 1-800-347-9800
www.rubbermaidcommercial.com

03/06 MP 20M SM664-J
©2006 by Rubbermaid Commercial Products LLC
3124 Valley Avenue, Winchester, VA 22601

Work Smarter.

