



VITAMIX® CONTAINERS

Use and Care Manual

Read and save these instructions

* Product image may differ slightly from actual container

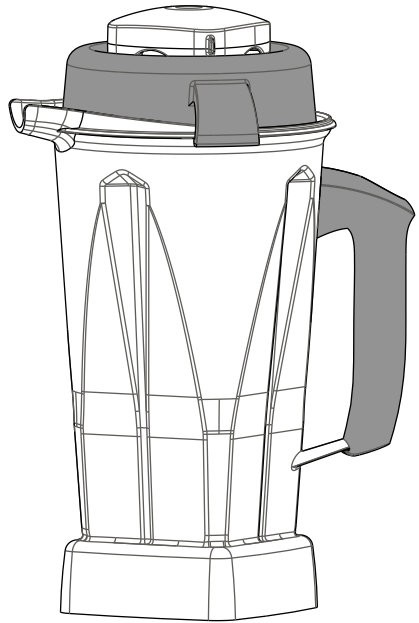

Vita-Mix® Corporation
8615 Usher Road
Cleveland, OH 44138-2103 U.S.A.
1.800.848.2649 / 1.440.235.4840
vitamix.com

CONTENTS

Contents	2
Important Safeguards	3
Parts and Features	6
About the Blades.....	8
Tamper	9
Operating Instructions	11
Care and Cleaning	12
Warranty.....	13
Notes	15

IMPORTANT SAFEGUARDS



WARNING: To avoid the risk of serious injury when using your new Vitamix® container with your Vitamix blender, basic safety precautions should be followed, including the following.



READ ALL INSTRUCTIONS, SAFEGUARDS, AND WARNINGS BEFORE OPERATING BLENDER.

1. Read all instructions.
2. Not intended for use by or near children or persons with reduced physical, sensory, or mental capabilities or lack of experience and knowledge. Close supervision is necessary when any appliance is used by or near children or incapacitated persons.
3. To protect against the risk of electrical shock, do not put the blender base in water or other liquid.
4. Unplug from outlet when not in use, before putting on or taking off parts, and before cleaning.
5. Avoid contacting moving parts.
6. Do not operate any appliance with a damaged cord or plug or after the appliance malfunctions, or is dropped or damaged in any manner. Call Vitamix Customer Service at 1.800.848.2649 or 1.440.235.4840 or email service@vitamix.com at once for examination, repair, replacement, or electrical or mechanical adjustment. If purchased outside the U.S.A. or Canada, contact your local Vitamix dealer.
7. Alteration or modification of any part of the blender base or container, including the use of any part or parts that are not genuine authorized Vitamix parts, may cause fire, electric shock, or injury.
8. The use of attachments not expressly authorized or sold by Vitamix for use with this blender, including canning jars, may cause fire, electric shock, or injury.
9. Do not use outdoors.
10. Do not let cord hang over edge of table or counter.
11. Do not let cord contact hot surface, including the stove.
12. Keep hands and utensils out of container while blending to reduce the risk of severe injury to persons or damage to the blender. A rubber scraper or spatula may be used, but only when the Vitamix blender is not running.
13. The tamper provided must be used only when the main part of the lid is in place.

IMPORTANT SAFEGUARDS

14. Blades are sharp. Handle or remove blade and blade assembly from the container with extreme care to avoid injury. To reduce the risk of injury, never place a blade assembly on the motor base unless assembled to the Vitamix container.
15. Do not leave foreign objects, such as spoons, forks, knives or the lid plug, in the container as this will damage the blades and other components when starting the machine and may cause injury.
16. Never attempt to operate with damaged blades.
17. Always operate blender with lid and lid plug firmly in place. The lid plug should be removed only when adding ingredients and when using the tamper.
18. When blending hot liquids or ingredients, use caution; spray or escaping steam may cause scalding and burns. Do not fill container to the maximum capacity. Always begin processing on the lowest speed setting, variable speed 1. Keep hands and other exposed skin away from the lid opening to prevent possible burns.
19. When making nut butters or oil-based foods, do not process for more than one minute after the mixture starts to circulate in the container. Processing for longer periods can cause dangerous overheating.

SAVE THESE INSTRUCTIONS

⚠ WARNING		
	To Avoid Injury. Read and understand instruction manual before using your container.	

IMPORTANT INSTRUCTIONS FOR SAFE USE

This product is intended for HOUSEHOLD USE ONLY and is not intended to be used for commercial purposes.

Do not leave your Vitamix blender unattended when operating.

Any repair, servicing, or the replacement of parts must be performed by Vitamix or an authorized service representative.

IMPORTANT SAFEGUARDS

⚠ WARNING



Electrical Shock Hazard.

Use grounded outlet only.

DO NOT remove ground.

DO NOT use an adapter.

DO NOT use an extension cord.

Failure to follow instructions can cause death or electrical shock.

NOTICE: THE FAILURE TO FOLLOW ANY OF THE IMPORTANT SAFEGUARDS AND THE IMPORTANT INSTRUCTIONS FOR SAFE USE IS A MISUSE OF YOUR NEW VITAMIX CONTAINER WITH YOUR VITAMIX BLENDER THAT CAN VOID ALL WARRANTIES AND CREATE THE RISK OF SERIOUS INJURY.

PARTS AND FEATURES

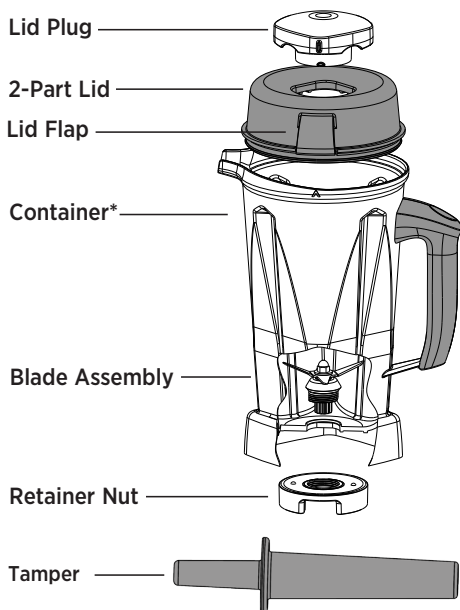

* Product image may differ slightly from actual container

2-Part Lid: Your new container has a lid that is easy to put on and take off, and easy to clean. Always use the lid and the lid plug when the machine is in operation.

! CAUTION: Lids and tampers are not interchangeable between different container styles, types, and sizes.

Snap the lid onto the container and leave in place for a few minutes. Once the lid has been left on the container, it will be much easier to lock or remove.

Container: Ounces, cups, and milliliters are clearly marked.



Tamper: While the machine is running, and only through the lid plug opening, use the tamper to press ingredients into the blades.

Lid Plug: Insert through the lid and secure by turning clockwise. Remove the lid plug to use the tamper or add ingredients.

PARTS AND FEATURES

To Lock the Lid in Place:

1. Position lid on container with lid flaps midway between the spout and the handle.
2. Push the lid onto the container until it locks in place.
3. The lid must always be secured when processing, especially hot liquids that may scald.

⚠ WARNING		
	<p>Rotating Blades Can Cause Severe Injury.</p> <p>DO NOT reach into container while machine is running.</p>	

To Remove the Lid: Lift up on one lid flap while holding the container securely.

To Remove the Lid Plug: Rotate the lid plug counterclockwise from the “locked” to “unlocked” position and lift out.

ABOUT THE BLADES

The Vitamix machine comes standard with the wet blade container. The blade is identified by a “W” for wet. This blade is used for most of your recipes. Additional containers with wet or dry blades may be purchased separately.

⚠ WARNING



Rotating Blades Can Cause Severe Injury.

DO NOT reach into container while machine is running.

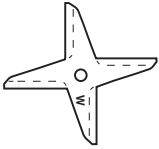

Wet Blade Container: Designed for processing liquids, including juice, frozen mixtures, sauces, soups, purees, batters, and for wet chopping. The wet blades can also grind grain and knead dough, but they are not quite as efficient as the dry blades in this application. If used for grinding, your container will mar and become cloudy; see instructions for dry container use.

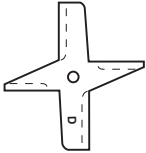

Dry Blade Container: These blades are clearly marked “D” and are designed specifically for grinding dry materials such as grains, cereal, and coffee, and are also used for kneading bread dough. The dry blades can NOT process liquids efficiently. *If you grind herbs on a regular basis, you may wish to purchase a separate dry blade container and replace blades as needed.*

⚠ CAUTION



Moving Parts May Become Hot With Extended Use.

DO NOT touch.



TAMPER

⚠ WARNING



Rotating Blades Can Cause Severe Injury.

DO NOT put hands, spatulas in the container while the machine is running or while the container is still on the motor base.

Lids and tampers are not interchangeable between different container styles, types, and sizes. Use the tamper that was supplied with your machine.



How to Determine the Tamper that Can Be Used with Your Container

Each type of tamper is designed to be used safely and effectively with a particular container. **If a tamper came with your container, it is the correct tamper for the container.** If a tamper did not come with your container, or you want to determine if a tamper that you already have can be used with your new container, please compare your container with the containers and matching tampers to the illustration below.

Before using the tamper during the blending process, verify that it is the correct tamper. For operating instructions, refer to the owner's manual that was provided with your Vitamix blender.

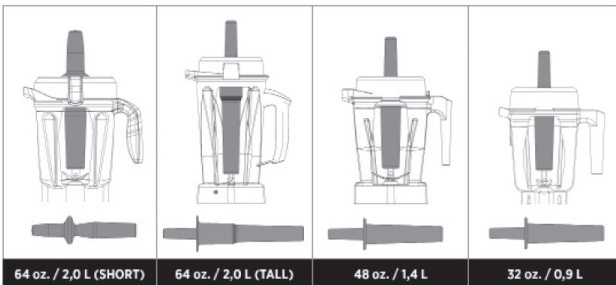

- 64 oz. Short Containers use Tamper P/N 016041 that is approximately 9-¾ inches long.
- 64 oz. Tall Containers use Tamper P/N 000760 that is approximately 12-½ inches long.
- 32 oz. and 48 oz. Containers use Tamper P/N 015033 that is approximately 11 inches long.

TAMPER

To verify that you are using the correct tamper, place the lid on an empty container, remove the lid plug and insert the tamper. If it is the correct tamper, it should easily fit into the opening but will not come in contact with the blades no matter how you move the tamper inside the container. IF THE TAMPER TOUCHES THE BLADES AT ANY ANGLE - DO NOT USE THE TAMPER WITH YOUR CONTAINER.



If you do not have the correct tamper for your container, call Vitamix Customer service at 1.800.848.2649 or 1.440.235.4840 or e-mail service@vitamix.com to order a new tamper. If purchased outside the United States or Canada, contact your local Vitamix Dealer.

OPERATING INSTRUCTIONS

Wet Blade Container

Designed for processing liquids including juice, frozen mixtures, sauces, soups, purees, batters, and for wet chopping.



For operating instructions, refer to the owner's manual that was provided with your Vitamix blender.

⚠CAUTION		
	<p>Never Start on High with Hot Liquids to Avoid Possible Burns.</p> <p>Escaping steam, splashes or contents may scald.</p> <p>To secure the contents, lock the lid and lid plug securely in place prior to operating the machine and always start on Low and then switch to High.</p>	

Dry Blade Container

If purchased, your dry blade container should only be used for hard, dry materials such as grain, and for kneading dough.

For operating instructions, refer to the owner's manual that was provided with your Vitamix blender.

⚠CAUTION		
	<p>Never Start on High with Hot Liquids to Avoid Possible Burns.</p> <p>Escaping steam, splashes or contents may scald.</p> <p>To secure the contents, lock the lid and lid plug securely in place prior to operating the machine and always start on Low and then switch to High.</p>	

CARE AND CLEANING

Container

To prepare your new container for initial use, follow the steps below.

1. Fill the container half full with warm water and add a couple drops of liquid dish washing detergent to the container.
2. Snap or push the complete 2-part lid into locked position.
3. Refer to owner's manual supplied with the machine. Set the machine to the lowest speed setting. Turn machine on and increase speed to the highest speed setting.
4. Run the machine on High speed for 30 to 60 seconds.
5. Turn off the machine, and rinse and drain the container.

Note: Some thick mixtures, such as breads and batters, may need additional washing by hand. When storing the lid on the container, either remove the lid plug or thoroughly dry both the lid and container to avoid trapping moisture.

Lid, Lid Plug and Tamper:

Separate the lid and lid plug. Wash the parts in warm soapy water. Rinse clean under running water, and dry. Reassemble before use.

IMPORTANT: To ensure continued and effective performance, do not put the container, lid, lid plug or tamper in the dishwasher.

WARRANTY

3-YEAR FULL WARRANTY ON SEPARATELY SOLD CONTAINER AND CONTAINER COMPONENTS

1. WHAT IS COVERED.

Vita-Mix Corporation (“Vitamix”) warrants that a container (the “Container”), lid, blade assembly and/or retainer nut (the “Container Component”) that is purchased separately from a blender motor-base will be free from defects in material or workmanship and will withstand wear and tear from ordinary household use for 3 years from the date of purchase. Vitamix will, within 30 days of receipt of the returned product, repair the failed Container or Container Component free of charge. If, in Vitamix’s sole discretion, the failed Container or Container Component cannot be repaired, Vitamix will elect to either (A) replace the Container or Container Component free of charge or (B) refund the full purchase price to the owner, unless Vitamix receives prior written notice of the owner’s preference.

2. WHAT IS NOT COVERED.

This Warranty applies only to owners for ordinary household use. This Warranty does not cover cosmetic changes that do not affect performance, such as discoloration or the effects of the use of abrasives or cleaners or food build up. This Warranty is only valid if the Container or container in which the Container Component is installed is used in accordance with the instructions, warnings and safeguards contained in the owner’s manual.

Vitamix will not be responsible for the cost of any unauthorized warranty repairs.

REPAIR, REPLACEMENT OR REFUND OF THE PURCHASE PRICE ARE THE EXCLUSIVE REMEDIES OF PURCHASER AND THE SOLE LIABILITY OF VITAMIX UNDER THIS WARRANTY. NO EMPLOYEE OR REPRESENTATIVE OF VITAMIX IS AUTHORIZED TO MAKE ANY ADDITIONAL WARRANTY OR ANY MODIFICATION TO THIS WARRANTY WHICH MAY BE BINDING UPON VITAMIX. ACCORDINGLY, PURCHASER SHOULD NOT RELY UPON ANY ADDITIONAL STATEMENTS MADE BY ANY EMPLOYEE OR REPRESENTATIVE OF VITAMIX. IN NO EVENT, WHETHER BASED ON CONTRACT, INDEMNITY, WARRANTY, TORT (INCLUDING NEGLIGENCE), STRICT LIABILITY OR OTHERWISE, SHALL VITAMIX BE LIABLE FOR ANY SPECIAL, INDIRECT, INCIDENTAL OR CONSEQUENTIAL DAMAGES, INCLUDING, WITHOUT LIMITATION, LOSS OF PROFIT OR REVENUE.

Some states do not allow limits on warranties. In such states, the above limitations may not apply to you. Outside the U.S.A. and Canada, other warranties may apply.

WARRANTY

3. WHAT VOIDS THIS WARRANTY.

Abuse, misuse, negligent use, alteration of the Container or Container Component or motor base, exposure to abnormal or extreme conditions, or failure to follow the operating instructions, will void this Warranty.

The Warranty is also void if repairs to the machine, Container, Container Component or any portion of the blade assembly are performed by someone other than Vitamix or an authorized Vitamix Service Provider or if any part subject to this Warranty is used in combination with a motor-base or container that is not expressly authorized by Vitamix.

4. HOW TO OBTAIN RETURN AUTHORIZATION UNDER THIS WARRANTY.

In the event the Container or Container Component needs service or repair, please call Vitamix Customer Service at 1.800.848.2649. You will be asked to provide a date of purchase and proof of purchase for any product that has not been registered with Vitamix. For product subject to this Warranty you will be provided with a return authorization number, up-to-date shipping instructions and a pre-paid return pick up label. Vitamix will pay standard shipping costs on the return of a Container or Container Component for warranty service and repair and for return shipment of the product to you after the warranty repair or replacement. Purchaser is responsible for the costs of special shipping requests.

Within the U.S.A. and Canada, this Warranty is honored directly through the Vita-Mix® Corporation.

United States

Vita-Mix® Corporation
8615 Usher Road
Cleveland, Ohio 44138-2199
1.800.848.2649
service@vitamix.com

Canada

Vita-Mix® Corporation
200-1701 Shepherd Street East
Windsor, Ontario N8Y 4Y5
1.800.848.2649
service@vitamix.com

You will be deemed to have accepted the returned product “as is” upon delivery unless you notify Vitamix of any problem, including shipment damage, within 48 hours of delivery.

SPECIAL INTERNATIONAL INSTRUCTIONS

If a machine was purchased within the U.S.A. or Canada,
but is currently outside the U.S.A. or Canada,
all shipping and resulting taxes and duties are at the owner's expense.
Call +1.440.235.4840 or email service@vitamix.com for more details.

To see the complete line of Vitamix® products,
visit **vitamix.com**.



Vita-Mix® Corporation
8615 Usher Road
Cleveland, OH 44138-2103 U.S.A.
1.800.848.2649 / 1.440.235.4840
vitamix.com

©2013 Vita-Mix® Corporation. No part of this publication may be reproduced or transmitted in any form or
by any means or stored in a database or retrieval system without the written permission of the Vita-Mix® Corporation.

Printed in the U.S.A.

103777 3/13