



30043

VHU INSULATED HUMIDIFIED CABINETS

VHU7
VHU18

- NOTICE -

This Manual is prepared for the use of trained Vulcan Service Technicians and should not be used by those not properly qualified.

This manual is not intended to be all encompassing. If you have not attended a Vulcan Service School for this product, you should read, in its entirety, the repair procedure you wish to perform to determine if you have the necessary tools, instruments and skills required to perform the procedure. Procedures for which you do not have the necessary tools, instruments and skills should be performed by a trained Vulcan Service Technician.

The reproduction, transfer, sale or other use of this Manual, without the express written consent of Vulcan, is prohibited.

This manual has been provided to you by ITW Food Equipment Group LLC ("ITW FEG") without charge and remains the property of ITW FEG, and by accepting this manual you agree that you will return it to ITW FEG promptly upon its request for such return at any time in the future.

TABLE OF CONTENTS

GENERAL	3
INTRODUCTION	3
INSTALLATION, OPERATION AND CLEANING	3
TOOLS	3
SPECIFICATIONS	3
SERVICE PROCEDURES AND ADJUSTMENTS	4
TEMPERATURE AND HUMIDITY CALIBRATION	4
RESET SENSOR CODES	4
HEATER ELEMENT TEST	4
REMOVAL AND REPLACEMENT OF PARTS	6
TOP COVER	6
COMPARTMENT FAN	6
HEATING ELEMENT	6
CONTROLLER BOARD - TEMPERATURE & HUMIDITY	8
SENSOR BOARD - TEMPERATURE & HUMIDITY	9
DOOR ASSEMBLY	10
DOOR GASKET	11
DOOR LATCH (MAGNETIC)	11
FUSE	11
FUSE HOLDER	12
ELECTRICAL OPERATION	13
COMPONENT LOCATIONS	13
COMPONENT DESCRIPTIONS	14
WIRING DIAGRAM	15
SEQUENCE OF OPERATION	15
TROUBLESHOOTING	16
TROUBLESHOOTING	16
ERROR CODES	16

GENERAL

INTRODUCTION

This manual is applicable only to models listed on the cover page. Procedures in this manual will apply to all models unless specified. Pictures and illustrations can be of any model unless they need to be model specific.

INSTALLATION, OPERATION AND CLEANING

For detailed installation, operation and cleaning instructions, refer to the Installation & Operation Manual sent with each unit. The manual is also available online at www.vulcanequipment.com.

TOOLS

Standard

1. Standard set of hand tools.
2. VOM with minimum of NFPA-70E CATIII 600V, UL/CSA/TUV listed. Sensitivity of at least 20,000 ohms per volt. Meter leads must also be rated at CAT III 600V.
3. Clamp on type amp meter with minimum of NFPA-70E CAT III 600V,UL/CSA/TUV listed.
4. Temperature tester (thermocouple type).
5. ESD (Electrostatic discharge) Protection Kit.

Special

- Handheld, digital temperature and humidity sensor Grainger No. 3LYH7 or equivalent.

SPECIFICATIONS

Electrical			
Model	Volts	Wattage	Amperage
VHU7 VHU18	120	1,500	12.5
VHU7 VHU18	120	2,000 (Optional)	16.7

Heating Elements			
Model	Wattage	Voltage	Resistance
VHU7 VHU18	1500 (Standard)	120	8.80-10.27

Heating Elements			
Model	Wattage	Voltage	Resistance
VHU7 VHU18	2000 (Optional)	120	6.57-7.66

Pan Capacity		
Model	Capacity *	
	12" X 20" X 2 1/2"	18" X 26" SHEET PANS
VHU7	14	7
VHU18	36	18

(* Capacity based on 3" spacing between pans.

SERVICE PROCEDURES AND ADJUSTMENTS

TEMPERATURE AND HUMIDITY CALIBRATION

⚠ WARNING The oven and its parts are hot. Use care when operating, cleaning or servicing the oven.

1. Check room temperature.
2. Place temperature and humidity probe at the center of the cabinet.
3. Set unit temperature to 145°F.
4. Set relative humidity to 65%RH.
5. Wait 45 minutes.
6. The temperature setting should be between 138 - 152F° and relative humidity between 45%RH - 85%RH.

VERIFY

- When using cabinet, frequently opening the door will affect average internal temperature. Modify set temperature as necessary to ensure product is held above appropriate food safe temperature.

RESET SENSOR CODES

⚠ WARNING The oven and its parts are hot. Use care when operating, cleaning or servicing the oven.

1. Reset unit (turn it off, then on).
2. Turn unit off and remove sensor cover.

NOTE: Sensor board is located inside cabinet at the top of the cavity toward the front.

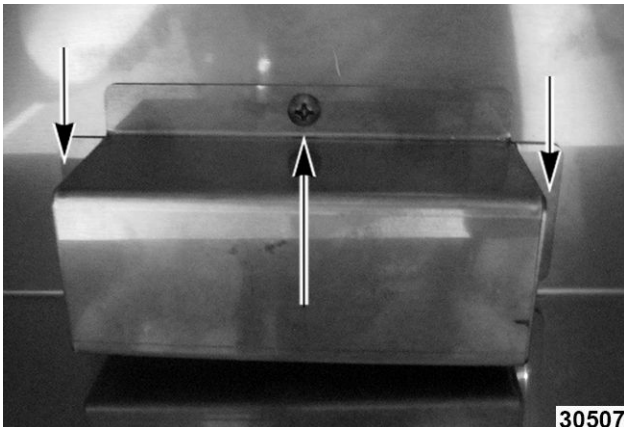

Fig. 1

3. Dry off sensor and wires.

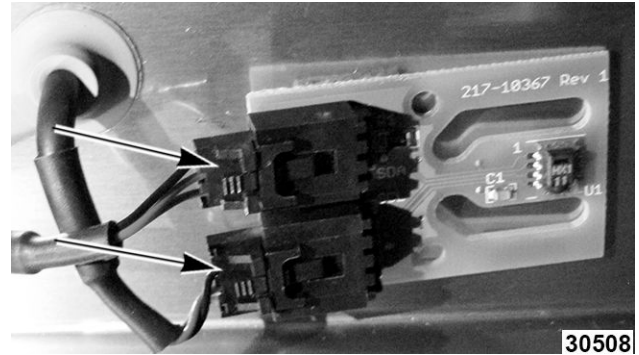

Fig. 2

4. Disconnect sensor wire harness plugs and dry out any moisture in connectors.
5. Plug sensor wire connectors into board.
6. Turn unit on to verify error code has cleared.
7. If error codes are not clear, replace both SENSOR BOARD AND WIRE HARNESS.
8. Install sensor board cover.
9. Verify operation.

HEATER ELEMENT TEST



⚠ WARNING Certain procedures in this section require electrical test or measurements while power is applied to the machine. Exercise extreme caution at all times and follow Arc Flash procedures. If test points are not easily accessible, disconnect power and follow Lockout/Tagout procedures, attach test equipment and reapply power to test.

1. Access the heater element being tested.
 - HUMIDITY ELEMENT (BELOW PAN)
 - AIR ELEMENT
2. Check resistance using HEATING ELEMENT table.

Heating Elements			
Model	Wattage	Voltage	Resistance
VHU7	1500	120	8.80-10.27
VHU18	(Standard)		

Heating Elements			
Model	Wattage	Voltage	Resistance
VHU7 VHU18	2000 (Optional)	120	6.57-7.66

REMOVAL AND REPLACEMENT OF PARTS

TOP COVER



WARNING Disconnect the electrical power to the machine and follow lockout / tagout procedures.

1. Remove eight screws securing top cover to cabinet.

NOTE: Fig. 3 Shown without top cooling fan (First Generation Production). Fig. 4 Shown with top cooling fan (Second Generation Production).



Fig. 3

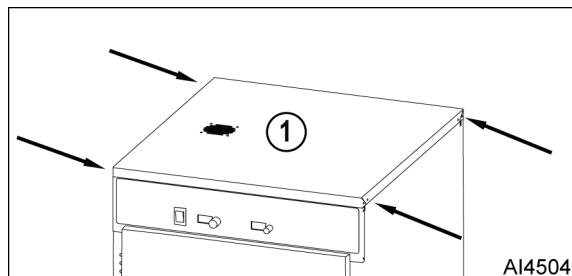

Fig. 4

2. Unplug fan cord, if applicable.
3. Lift top cover off cabinet.
4. Reverse procedure to install.

COMPARTMENT FAN



WARNING Disconnect the electrical power to the machine and follow lockout / tagout procedures.

1. Remove upper pans and pan supports for clearance to access fan.
2. Loosen fan mounting screws.

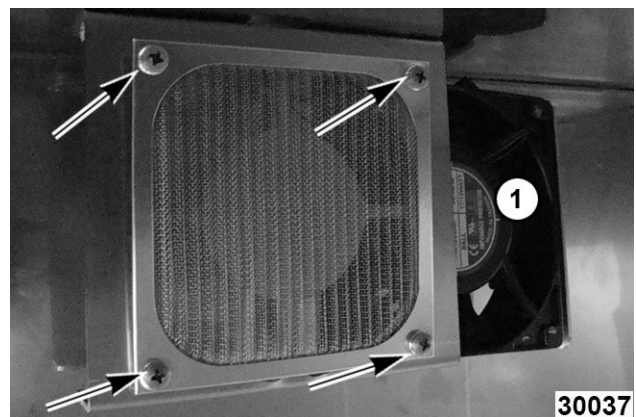

Fig. 5

3. Slide fan (1, Fig. 5) to access power connector.
4. Disconnect power connector.
5. Reverse procedure to install and check for proper operation.

HEATING ELEMENT



WARNING Disconnect the electrical power to the machine and follow lockout / tagout procedures.

Humidity Element (Below Pan)

1. Remove pans and tray slides.
2. Remove water holding pan.
3. Remove screw securing heating element mounting clip to bottom of cabinet.

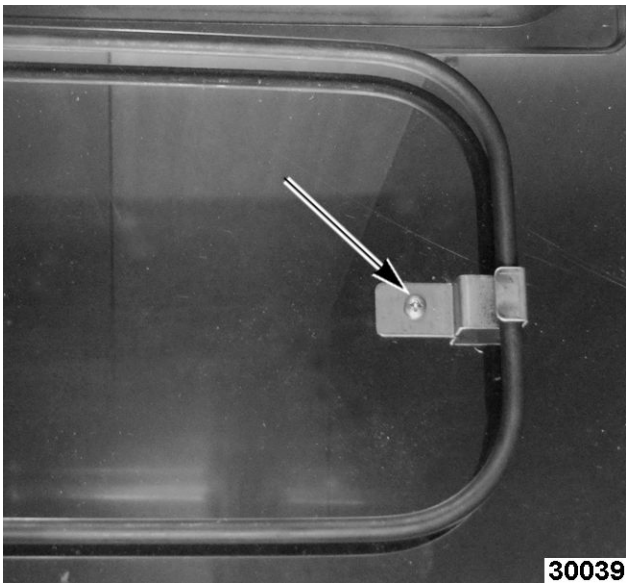

Fig. 6

4. Remove two screws securing element.



Fig. 7

5. Pull element out.
6. Disconnect heating element wires.

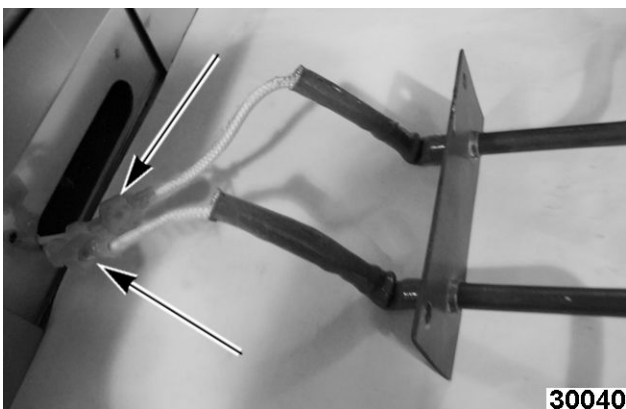

Fig. 8

7. Reverse procedure to install and check for proper operation.

Air Element

1. Remove pans and tray slides.
2. Loosen rail guide support screws.
3. Remove rail guides.



Fig. 9

4. Remove bottom screws from side panel.

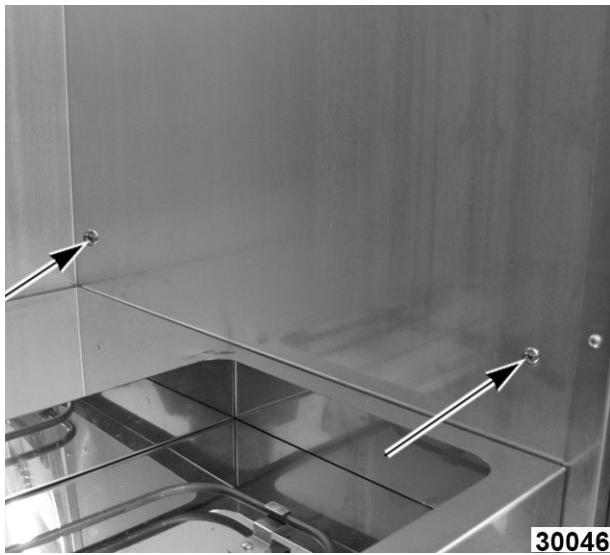

Fig. 10

5. Remove bottom cover screws.



Fig. 11

6. Carefully clear element while lifting cover from right side.



Fig. 12

7. Remove two screws securing element.



Fig. 13

8. Pull element out.
9. Disconnect heating element wires.

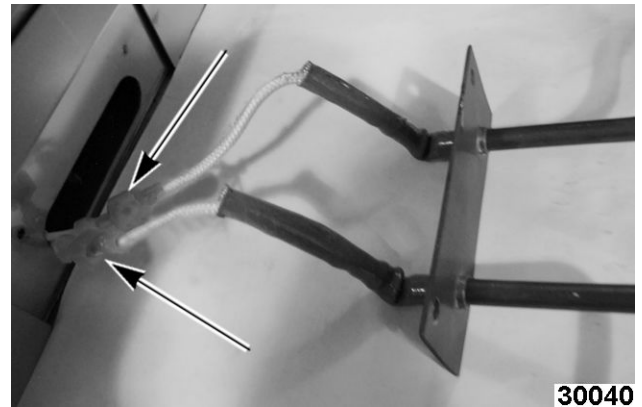

Fig. 14

10. Reverse procedure to install and check for proper operation.

CONTROLLER BOARD - TEMPERATURE & HUMIDITY



⚠ WARNING Disconnect the electrical power to the machine and follow lockout / tagout procedures.

1. Remove temperature and humidity adjustment knobs.
2. Remove two nuts on front of board.
3. Remove TOP COVER.
4. Lift insulation and fold back toward rear of cabinet.
5. Remove controller board mounting nuts.

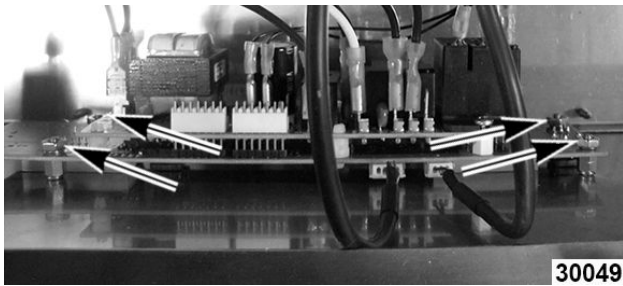

Fig. 15

6. Lift controller board to access wire connections.
7. Note wire locations and disconnect from controller board.
8. Reverse procedure to install and check for proper operation.

SENSOR BOARD - TEMPERATURE & HUMIDITY



WARNING Disconnect the electrical power to the machine and follow lockout / tagout procedures.

NOTE: Sensor board is located on top of door inside cabinet.

Sensor Board

1. Disconnect power supply.
2. Remove sensor board cover.

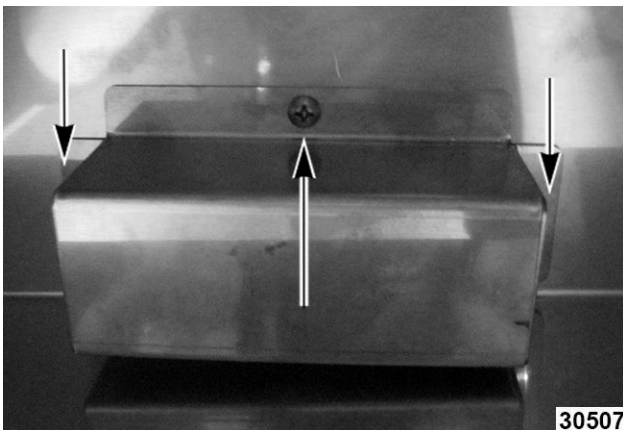

Fig. 16

3. Disconnect sensor wire plugs.

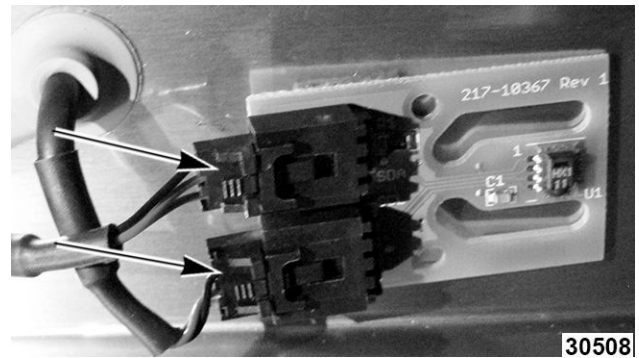

Fig. 17

4. Remove double-sided tape from cabinet surface.
5. Clean cabinet surface.
6. Apply double-sided tape to sensor and mount.
7. Plug sensor wire connectors into board.
8. Verify proper operation.

Sensor Board Wire Harness

1. Remove sensor board cover.

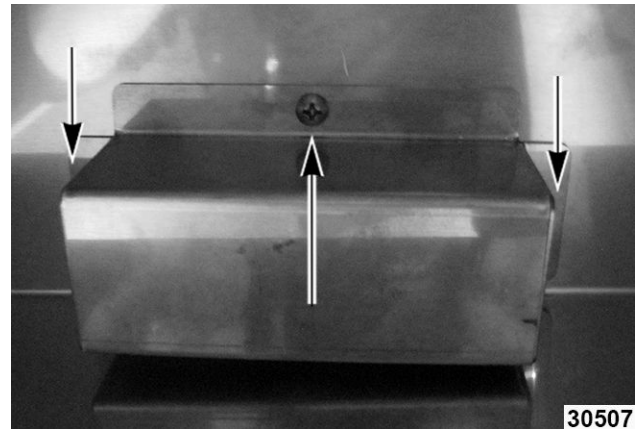

Fig. 18

2. Disconnect sensor wire plugs.

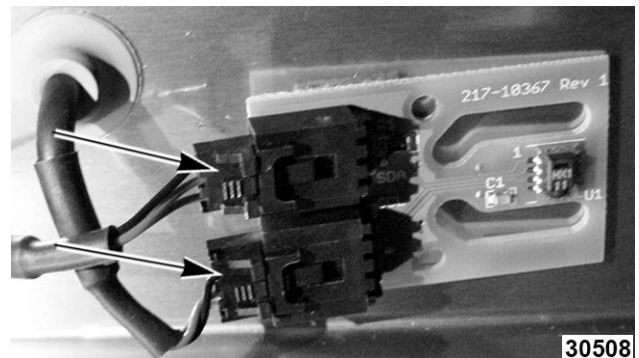

Fig. 19

3. Remove TOP COVER.
4. Disconnect wire harness plugs from board.

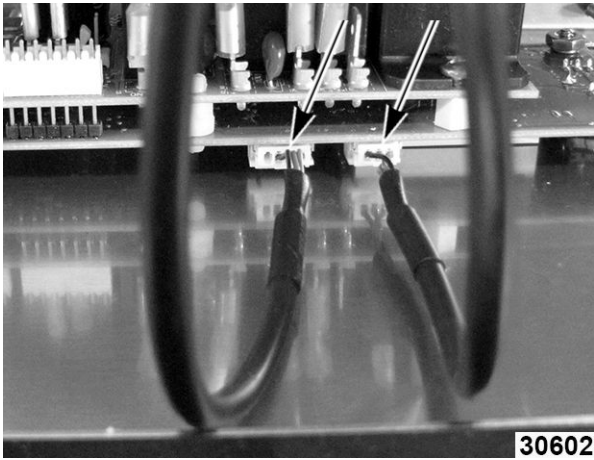

Fig. 20

5. Release grommets from top panel.

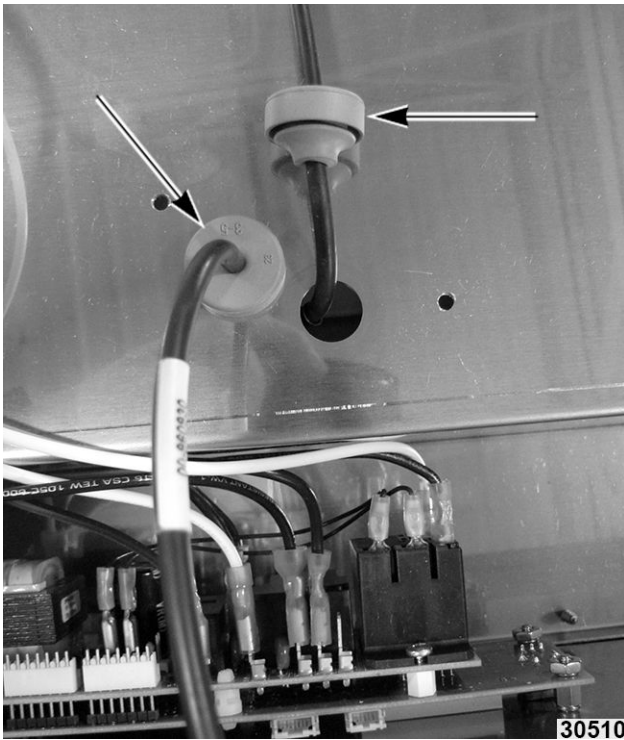

Fig. 21

6. Pull wire harness out.
7. Reverse steps to install.

NOTICE Position grommets correctly during installation so they retain moisture from escaping.

8. Verify proper operation.

DOOR ASSEMBLY

1. Remove door hinge covers (1, Fig. 22) from lower and upper door hinge.

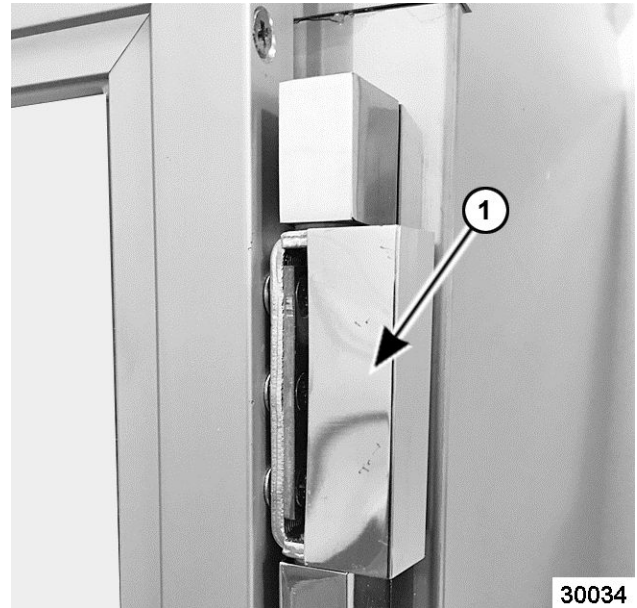

Fig. 22

WARNING Remain in control of door when removing hinges.

2. Remove door hinge inside mounting screws from **lower door hinge first**.



Fig. 23

3. Remove door hinge inside mounting screws from **upper door hinge** while supporting door weight.
4. Lift door assembly from cabinet.
5. Reverse procedure to install.
6. Check for proper operation.

DOOR GASKET

1. Open door to access gasket.
2. Remove door gasket by pulling it out from retaining channel in door assembly.

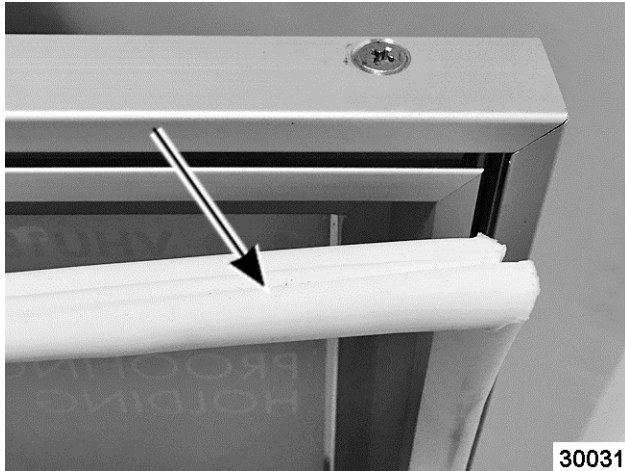
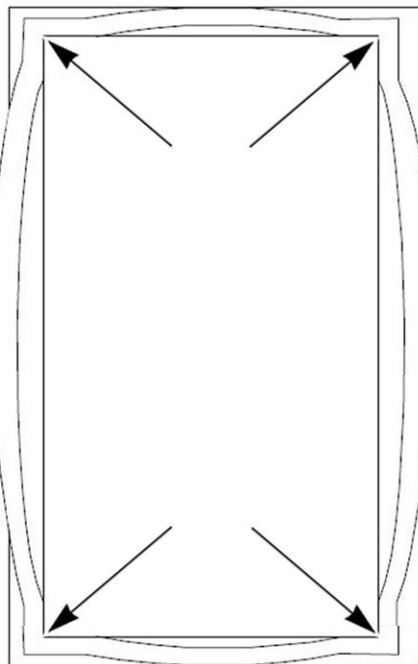

Fig. 24

3. Install gasket in each corner on door assembly.
 - A. Press gasket retaining lip into channel on door assembly.
 - B. Work gasket into channel about four inches away from corner, in each direction.



30032

Fig. 25

4. Starting at the top, press gasket retaining lip into channel on door assembly while moving toward **middle**.

5. Repeat each side to complete gasket installation.
6. Check door for proper operation.

DOOR LATCH (MAGNETIC)

1. Open door.
2. Remove screws securing door latch to door assembly.

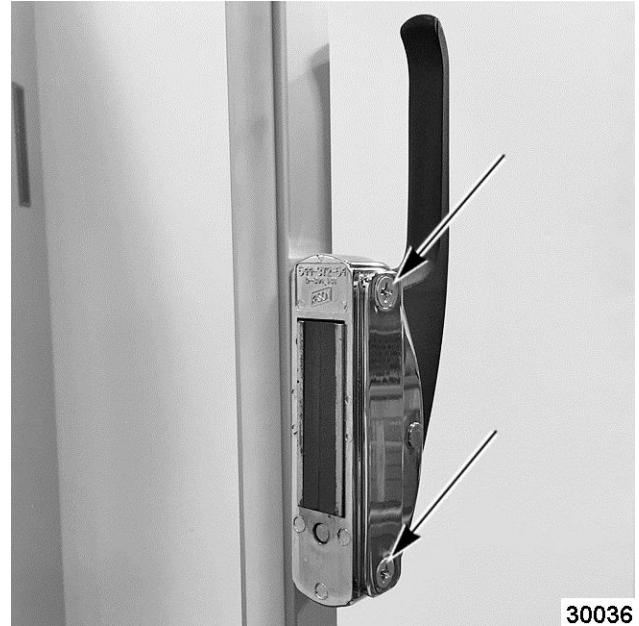

Fig. 26

3. Reverse procedure to install.
4. Check for proper operation.

FUSE



⚠ WARNING Disconnect the electrical power to the machine and follow lockout / tagout procedures.

1. Unscrew fuse cover from back panel.

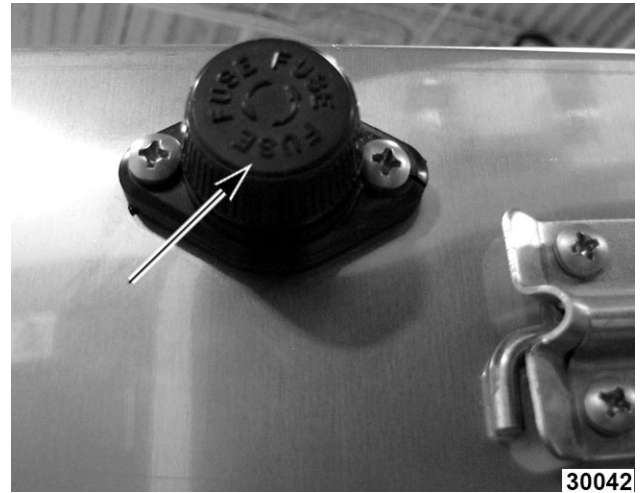
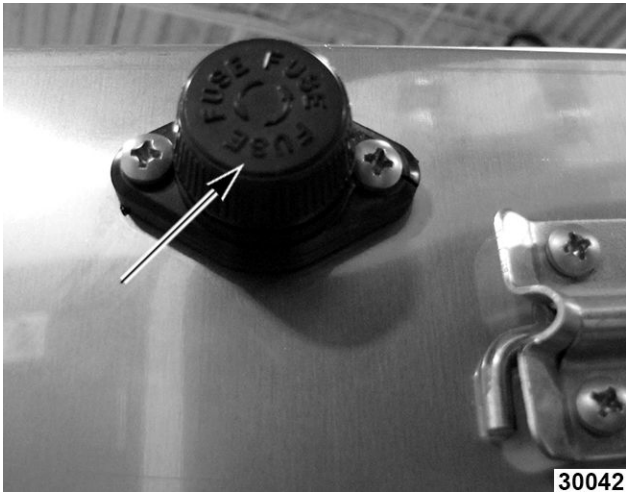

Fig. 29

2. Replace with same size and type of fuse.
3. Install cover.

4. Reverse procedure to install and verify proper operation.

FUSE HOLDER



⚠ WARNING Disconnect the electrical power to the machine and follow lockout / tagout procedures.

1. Remove TOP COVER.
2. Note fuse wiring and disconnect.

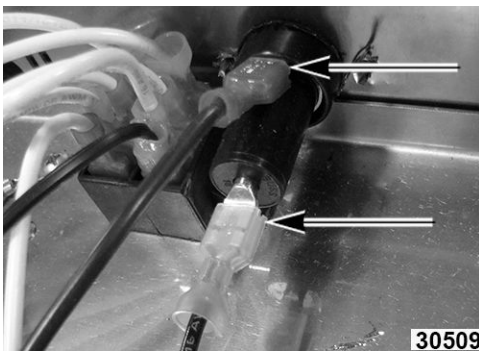
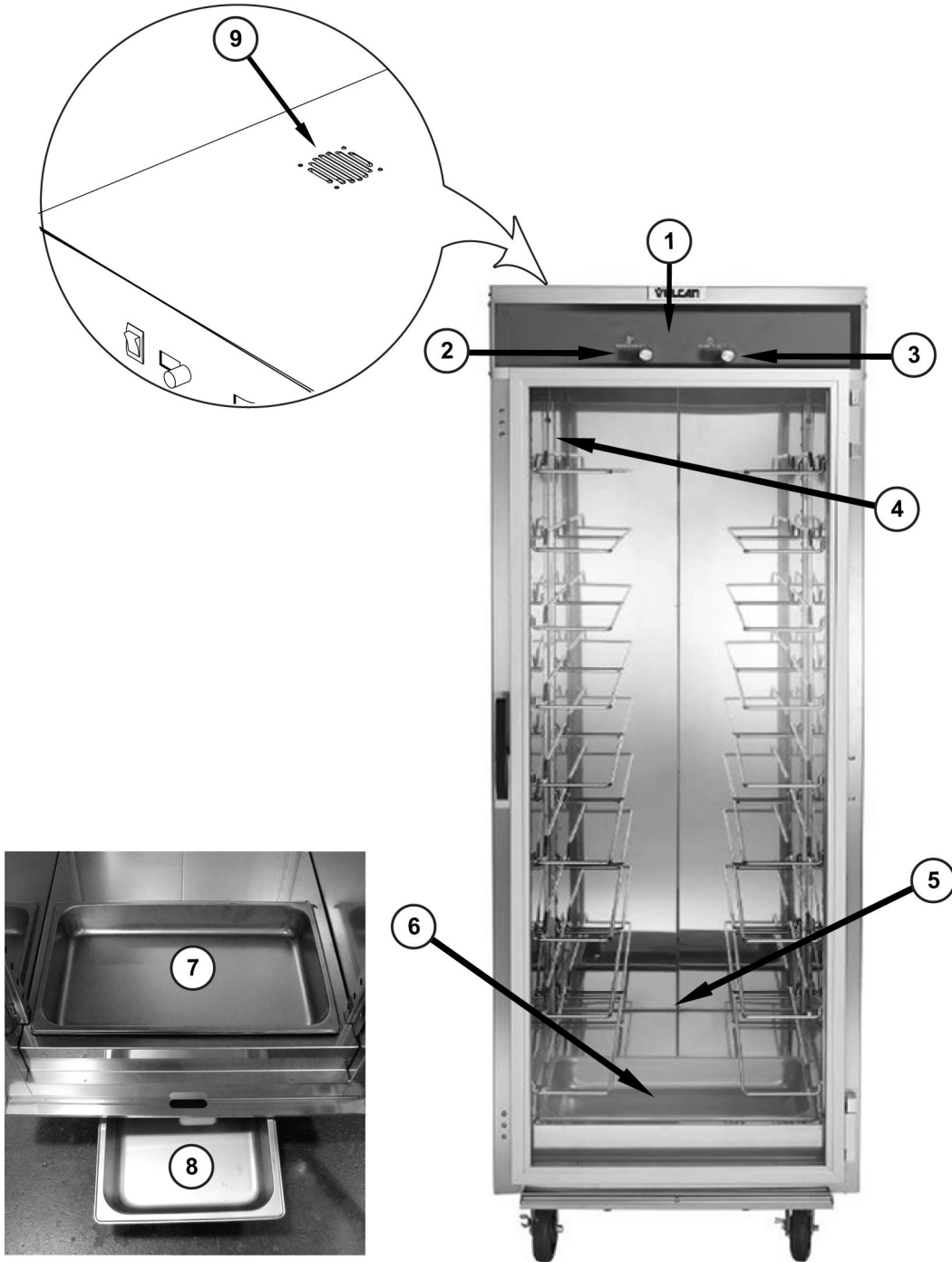

Fig. 28

3. Remove fuse holder mounting screws on back panel.

ELECTRICAL OPERATION

COMPONENT LOCATIONS



30030

Fig. 30

Item	Description
1	Temperature & humidity Controller (behind control panel)
2	Temperature Adjustment
3	Humidity Adjustment
4	Compartment Fan
5	Heating element air (below bottom cover)
6	Heating element humidity (below pan)
7	Coated Pan
8	Stainless Steel Pan
9	Cooling Fan

COMPONENT DESCRIPTIONS

ITEM	DESCRIPTION
Fuse	Protects controller board and electrical components.
Power Switch	Provides power to the control circuit. Internal red light indicates ON (SPST).
Compartment Fan	Circulates air inside the cabinet. Moisture resistant with metal fan blades.
Sensor Board	Senses temperature and humidity inside the cabinet and transmits signal to controller board.
Controller Board	Controls the temperature, humidity and fan inside the cabinet.
Heating Element - Below Water Pan	Heats the water to provide humidity.
Heating Element - Dry	Heats the air to keep prepared food at the proper serving temperatures.
Cooling Fan	Circulates air in the electrical component area.

WIRING DIAGRAM

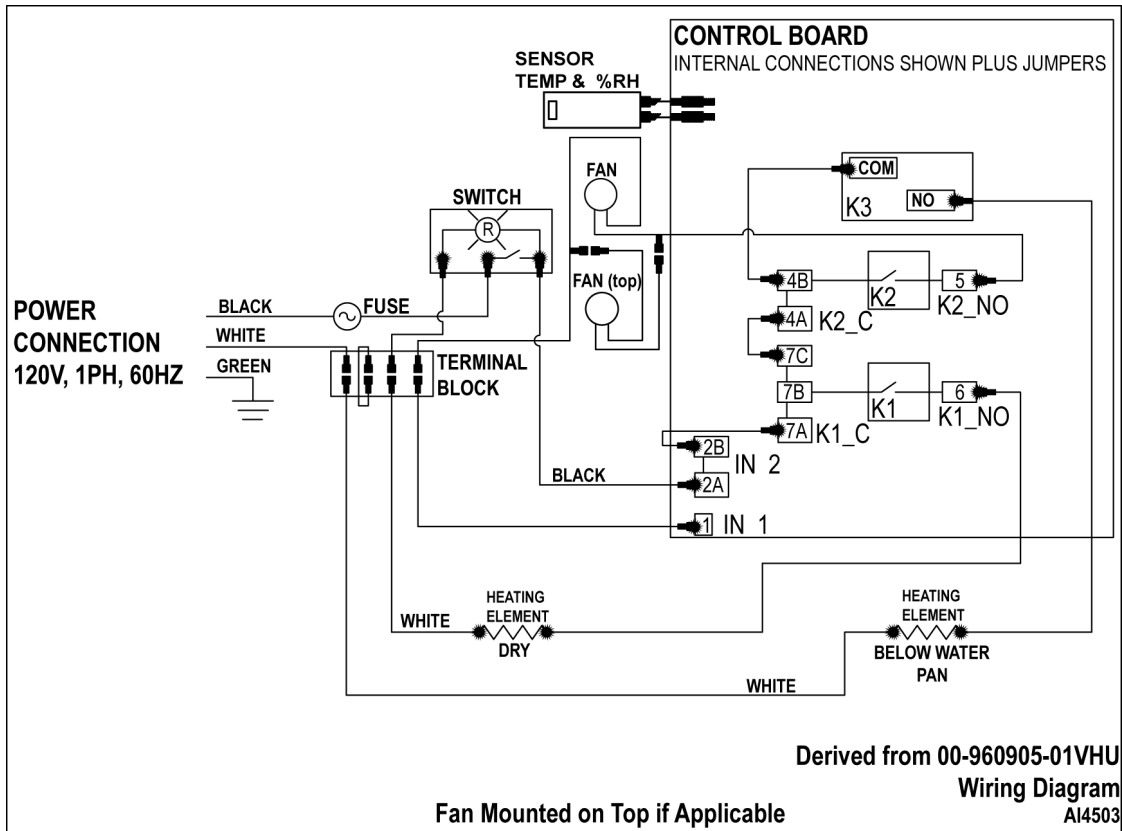

Fig. 31

SEQUENCE OF OPERATION

1. Conditions.
 - A. Unit connected to correct voltage and is properly grounded.
 - B. Power switch is off.
2. Power switch turned on.
 - A. Relays K1, K2 and K3 are de-energized (contacts N.O.).
 - B. Controller board performs diagnostic test and verifies temperature and humidity input signals are present.
 - C. If no errors codes display, the temperature and humidity settings flash in each display window.
3. Fan relay K2 is energized, K2 contacts close and power the fans.
4. Based on temperature and humidity settings, the board determines whether K1 relay will be energized to power element 1 (dry air); or K3 relay will be energized to power element 2 (humid air).

NOTE: When temperature or humidity settings are changed, after a brief pause, both element relays (K1 & K3) will be de-energized and return to N.O. position. Heating and humidity generation stop. The relay numbers will flash in each display window. Based on temperature and humidity level in cabinet vs. setting, the controller board determines which relay to energize. The number of the energized relay will flash in display window.

5. Adjust temperature and humidity to desired levels.
6. Turn power switch off stops heating cycle.

TROUBLESHOOTING

TROUBLESHOOTING

Symptom	Possible Cause
Cabinet not operating.	<ol style="list-style-type: none"> 1. Cabinet not connected to power source or circuit breaker tripped. 2. Cabinet lighted power switch not ON or malfunctioning.
Ground Fault Circuit Indicator (GFCI) tripped.	<ol style="list-style-type: none"> 1. Shorted heating element. 2. Pinched/damaged wiring (heating elements or fan). 3. Damaged power cord.
Cabinet connected to power, switch is ON, circuit breaker is ON but cabinet not heating.	<ol style="list-style-type: none"> 1. Heating element malfunction. 2. Temperature controller malfunction.
Cabinet not heating properly.	<ol style="list-style-type: none"> 1. Door not sealing properly. 2. Fan not circulating air or malfunction. 3. Temperature controller needs calibrating or malfunction.
Fan not operating	<ol style="list-style-type: none"> 1. Temperature controller not supplying power to fan (malfunction). 2. Fan wiring not connected or malfunction. 3. Fan not circulating air or malfunction.
Error codes, E01, E02, or E03.	<ol style="list-style-type: none"> 1. <u>RESET SENSOR CODES</u> .
Moisture present at the top of the cabinet near the control board.	<ol style="list-style-type: none"> 1. Fan mounted to top cover blocked off. 2. Fan mounted to top cover not functioning. 3. Fan mounted to top cover missing.

ERROR CODES

Code	Description	Correction
E01	Displays when controller detects and open temperature sensor	Refer to: <u>RESET SENSOR CODES</u>
E02	Displays when controller detects a shorted temperature sensor.	
E03	RH Display is ON and there is a short 10 RH error.	