



Ice Machine Cleaning & Sanitizing

HOSHIZAKI

KMS-822MLH

The ice maker must be cleaned & sanitized at least once a year.

Cleaning Prep:

- 1 Remove the **Front Panel**, move the control switch to **OFF**. After 3 min., move the switch to **ICE**, then replace the panel.
- 2 After 3 min., remove the **Front Panel**, move the switch to **OFF**.
- 3 Remove all ice from the ice storage bin and/or dispenser.

WARNING! IF ON DISPENSER, turn off the dispenser power supply after dispensing all the leftover ice.

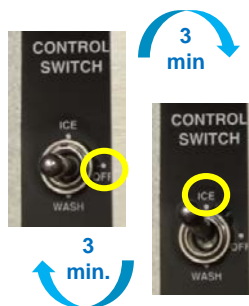

WARNING!

DO NOT leave icemaker unattended when panels are off



Cleaning:

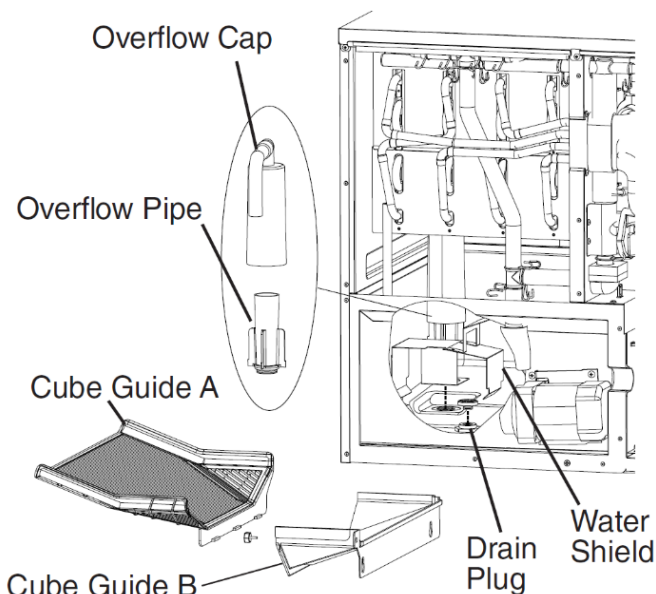

Front View of Ice Maker

- 4 Remove the **Front Insulation Panel, Cube Guide B & A, Overflow Cap & Pipe, Water Shield, and Drain Plug**. After the water tank has drained, replace all items.

NOTICE! DO NOT cross thread the drain plug or overflow pipe.

- 5 Refill water tank by moving the control switch to **ICE**, replace the **Front Panel**. After 3 minutes, remove **Front Panel**, move switch to the **OFF** position.

- 6 Remove the **Front Insulation Panels**. Pour **14 fl.oz (414 ml)** of Hoshizaki **Scale Away** into the water tank. Replace the front insulation panel. Turn the cleaning valve left until completely vertical (open).

NOTICE! AVOID EXCESSIVE FOAMING, wait 1 minute before next step.

- 7 Move the control switch to **WASH**, replace **Front Panel**.

NOTICE! DO NOT leave the control switch on WASH for extended periods when water tank is empty. It will damage water pump seals.

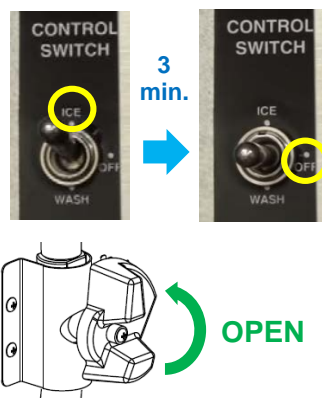

Sanitizing:

- Fill the water tank 14
- **CLOSE** the cleaning valve
- Move control switch to **ICE**, replace the front panel
- After 3 minutes, remove the front panel
- Move control switch to **OFF**

- Remove the front insulation panel 15
- Pour **.78 fl. oz (23 ml)** of chlorine bleach* into the water tank
- Replace the front insulation panel
- **OPEN** the cleaning valve

* Use bleach without additives. Additives cause excessive foaming, and reduces effectiveness of the cleaning.

- Wait 1 minute to avoid excessive foaming 16
- Move control switch to **WASH**, replace the front panel

- After 45 minutes, remove the front panel 17
- Remove the front panel
- Move the control switch to **OFF**

- Remove the front insulation panel, cube guide B & A, overflow cap & pipe, water shield, and drain plug 18

- After the water tank has drained, replace all items

↳ continued on the back...

- 8 After 30 minutes, remove **Front Panel**, then move the control switch to **OFF**.
- 9 Remove the **Front Insulation Panel, Cube Guide B & A, Overflow Cap & Pipe, Water Shield, and Drain Plug**. Clean all items (See Step 10). After the water tank has drained, replace all items.
- 10 In bad water conditions, a more thorough cleaning may be required. Turn off power supply, clean all items in a solution of **5 oz. of Scale Away per gallon of warm water**. Rinse and replace the cube guides, float switch, water supply tubes, spray tubes and spray guides. Turn on power supply. Otherwise, continue to step 11.



Cleaning Rinse:

- 11 Turn the cleaning valve to the *right* until completely horizontal (closed). Move the control switch to **ICE**, replace **Front Panel**. After 3 minutes, remove the **Front Panel**, move switch to **OFF**.
- 12 Turn the cleaning valve to the *left* until completely vertical (open). Move the control switch to **WASH**, replace the **Front Panel**. After 5 minutes, remove the **Front Panel**, switch to **OFF**.
- 13 Remove the **Front Insulation Panel, Cube Guide B & A, Overflow Cap & Pipe, Water Shield, and Drain Plug**. After the water tank has drained, replace all items.

NOTICE! ICE MACHINE WILL NOT WORK, unless valve is completely closed.

Continue to **Sanitation – Step 14** on front...

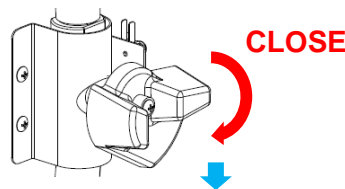

CONTROL PANEL
ICE > 3 minutes > OFF

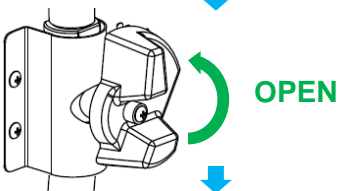

CONTROL PANEL
WASH > 5 minutes > OFF

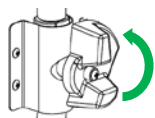

OPEN cleaning valve:

- To allow cleaning solution flow to the inside the evaporator
- Turn left to open (vertical)

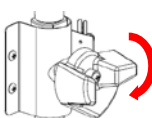

CLOSE cleaning valve:

- Must be closed for normal ice making operation
- Turn right to close (horizontal)

↳ sanitizing continued...

RINSE 1: (Steps 19-21)

- **CLOSE** cleaning valve 19
- Move control switch to ICE, replace the front panel
- After 3 minutes, remove the front panel
- Move control switch to OFF

RINSE 2: (Steps 22-27)

- **OPEN** cleaning valve 20
- Move control switch to WASH, replace the front panel
- After 5 minutes, remove the front panel
- Move control switch to OFF

RINSE 3: (Steps 28-30)

- Remove the front insulation panel, cube guide B & A, overflow cap & pipe, water shield, and drain plug 21
- After the water tank has drained, replace all items

RINSE 2 & 3: (Steps 22-27)

- Repeat 2x (Steps 19–21) for complete ice/food safety 22
- Clean the dispenser / storage bin liner with a neutral cleaner (dish soap) 28
- Rinse thoroughly

RINSE 1: (Steps 19-21)

- **CLOSE** the cleaning valve 29
- Move control switch to ICE
- Replace all panels 30

DOWNLOAD COMPLETE INSTRUCTION MANUAL:



hoshizakiamerica.com/support

Type in the model number of your ice machine (including dashes) to download manuals

CLEANING SCHEDULE

- | | |
|-----------------------------|----------------------------|
| • Scoop | Dish soap, rinse well |
| • Water Filters | Check psi, change if req'd |
| • Exterior | Dish soap & damp cloth |
| • Bin Door/Top Kit | Warm water & clean cloth |
| • Ice Maker/Bin | Follow these instructions |
| • Water Supply Inlet | Clean inlet screen |
| • Condenser | Inspect. Clean with brush |
| • Water Hoses | Inspect. Replace if req'd |
- **DAILY** | • **MONTHLY** | • **YEARLY**

WARNING!

DO NOT use ammonia type cleaners. Can cause damage to icemaker

WEAR liquid-proof gloves and goggles to protect skin & eyes from cleaning & sanitizing chemicals

NOTICE!

IF ICE MAKER IS ON DISPENSER, remember to turn on the dispenser after cleaning

