

Charging Cart Instructions

06/15/16

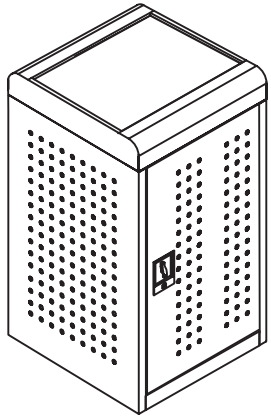

A x1

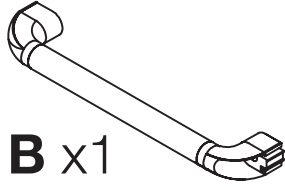

B x1



C x2



D x1

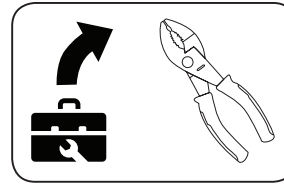

E x2

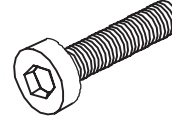

G x2



J x1



F x1

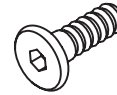

H x2



K x1



L x2



1

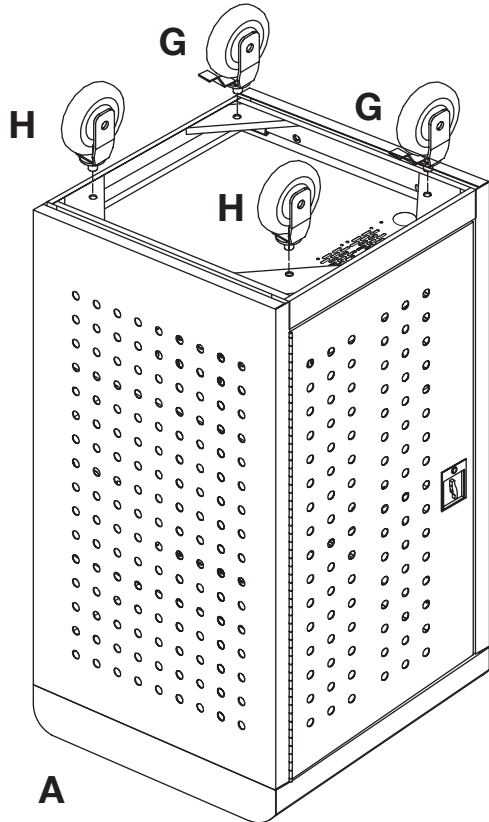

2

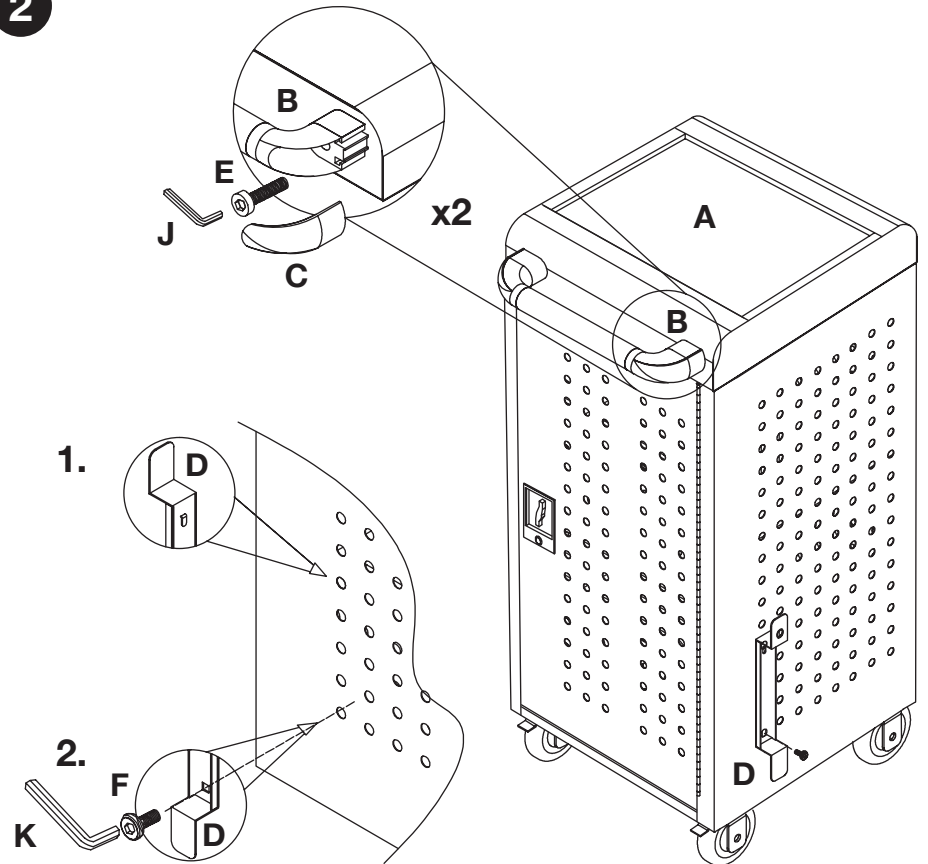

Heavy Lifting:
Assistance
Required