

Replacement Parts for Backsplash Faucets

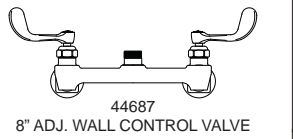

44687
8" ADJ. WALL CONTROL VALVE

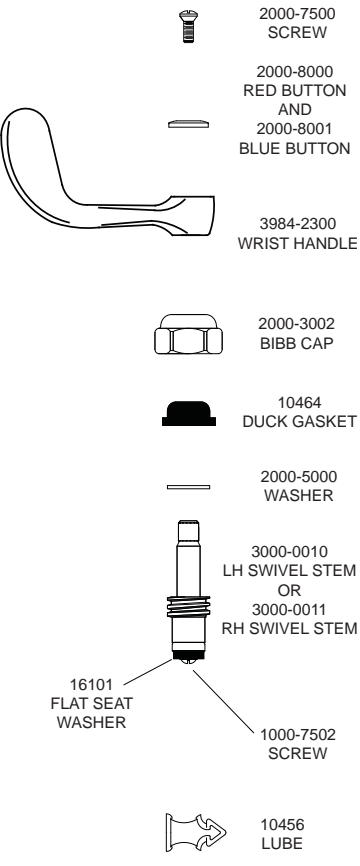

2000-7500 SCREW
2000-8000 RED BUTTON AND 2000-8001 BLUE BUTTON
3984-2300 WRIST HANDLE
2000-3002 BIBB CAP
10464 DUCK GASKET
2000-5000 WASHER
3000-0010 LH SWIVEL STEM OR 3000-0011 RH SWIVEL STEM
16101 FLAT SEAT WASHER
1000-7502 SCREW
10456 LUBE

89621 RH SWIVEL STEM REPAIR KIT OR 89613 LH SWIVEL STEM REPAIR KIT

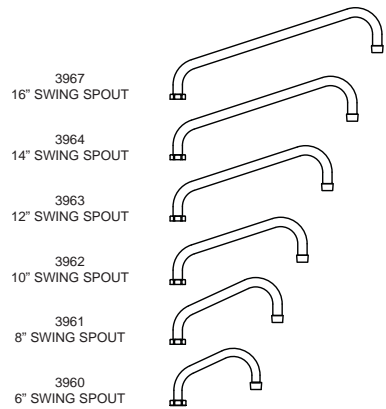

3967 16" SWING SPOUT
3964 14" SWING SPOUT
3963 12" SWING SPOUT
3962 10" SWING SPOUT
3961 8" SWING SPOUT
3960 6" SWING SPOUT

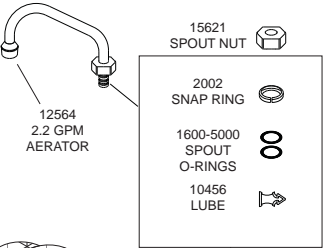

12564 2.2 GPM AERATOR
15621 SPOUT NUT
2002 SNAP RING
1600-5000 SPOUT O-RINGS
10456 LUBE

10014 (24") 10022 (36") SUPPLY LINE 1/2" F X 1/2" F
10049 (24") 10006 (36") SUPPLY LINE 1/2" M X 1/2" F

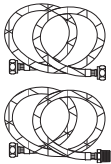

19119 SWIVEL SPOUT RETRO-FIT KIT

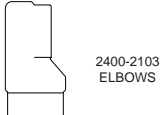

2400-2103 ELBOWS

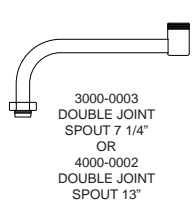

3000-0003 DOUBLE JOINT SPOUT 7 1/4" OR 4000-0002 DOUBLE JOINT SPOUT 13"

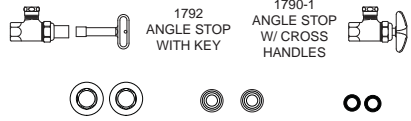

1792 ANGLE STOP WITH KEY
1790-1 ANGLE STOP W/ CROSS HANDLES
3200-2306 CONCENTRIC FLANGES
18694 1/2" CONCENTRICS
2200-5000 CONCENTRIC GASKETS

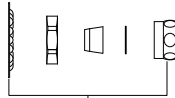

1000-8002 SLIP JOINT KIT



8" C/C Backsplash Faucet Product Installation Guide

Since 1936, Fisher Manufacturing Company has manufactured heavy-duty, high quality plumbing products and hardware specialties for the food service industry. For three generations, the Fisher family has adhered to a strict dedication of and overall value. When you install Fisher products... you install the best. Our hardware is manufactured with the standardization of internal mechanisms. All chrome plating is triple plated copper, nickel and chrome for durability. Every piece of equipment we make is rigorously tested in both our modern in-house testing center and in actual field situations under extreme conditions. Every detail is thoroughly checked. Before we make our products available to you, they pass each and every test. You get proven performance. Guaranteed.

Limited One Year Warranty

Fisher Manufacturing Company warrants its products and parts thereof (except as noted below) against defects in materials or workmanship for a period of one year after the date of original purchase. During this period Fisher Manufacturing Company will replace a defective product or part without charge to you, provided that the entire product is delivered to Fisher Manufacturing Company. All transportation and insurance charges for shipping the product to and from Fisher Manufacturing Company must be borne by you. Charges for transportation and insurance may, at the option of Fisher Manufacturing Company, be refunded depending upon our investigation of the warranty claim. This warranty does not cover external finish (except at date of original purchase) or labor costs not specifically authorized by Fisher Manufacturing Company.

A full and complete copy of our One Year limited warranty is available upon request.

WARNING:

Proposition 65 requires that we provide you with the following notice: "This product Contains A Chemical Known To The State Of California To Cause Birth Defects Or Other Reproductive Harm."



- #48801 - 8" c/c Backsplash Faucet with 6" Swing Spout
- #48828 - 8" c/c Backsplash Faucet with 8" Swing Spout
- #48836 - 8" c/c Backsplash Faucet with 10" Swing Spout
- #48844 - 8" c/c Backsplash Faucet with 12" Swing Spout
- #48852 - 8" c/c Backsplash Faucet with 14" Swing Spout
- #48860 - 8" c/c Backsplash Faucet with 16" Swing Spout

KEEP THIS MANUAL FOR FUTURE REFERENCE



ANSI/A112.18.1M, ANSI/NSF 61.9

FISHER MANUFACTURING COMPANY - TOLL FREE: 800-421-6162 FAX: 800-832-8238

Installation Instructions for Backsplash Faucets

BE SURE TO CHECK WITH YOUR LOCAL DEPARTMENT HAVING JURISDICTION REGARDING BACKFLOW PREVENTION

Installation Notes:

- Be sure to shut off water supply before beginning.
- Use pipe thread sealant such as PST on all threaded joints.
- Check the packaging for missing items BEFORE beginning installation. If items are missing, contact your supplier.

Tools Required for Installation

- Medium Sized Crescent Wrench
- Pipe Thread Sealant



Package Contents

The box should contain the following:

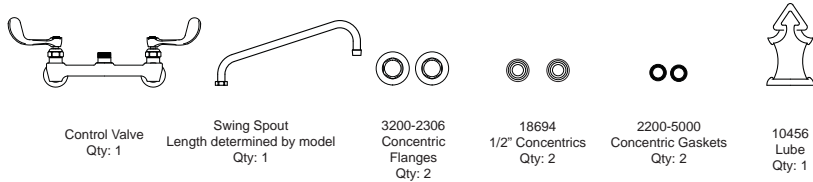

Control Valve
Qty: 1

Swing Spout
Length determined by model
Qty: 1

3200-2306
Concentric
Flanges
Qty: 2

18694
1/2\"/>

2200-5000
Concentric Gaskets
Qty: 2

10456
Lube
Qty: 1

Installation Instructions

1. After unpacking items and checking for missing components, insert the gasket into the groove on the concentric. Making sure gasket is in place, loosely mount the concentric and flange onto the control valve body.
2. Mount control valve body to the backsplash by inserting the concentrics through the backsplash and attaching slip joints. Tighten concentrics and attach elbows and supply lines (not included) as required. Be sure to use pipe thread sealant on all threads.
3. Optional DJ swivel spout, apply lube to the o-ring on the spout. Mount the DJ swivel spout and tighten the nut onto the faucet spout outlet.
4. Apply lube to the o-rings on the swing spout. Make sure the white snap ring is in place before mounting the swing spout. Mount the swing spout and tighten the swing spout nut onto the faucet spout outlet.
4. Turn on water supply and check for leaks.

Step 1

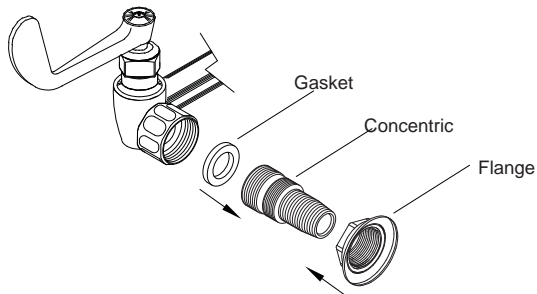

Installation Instructions Continued

Step 2

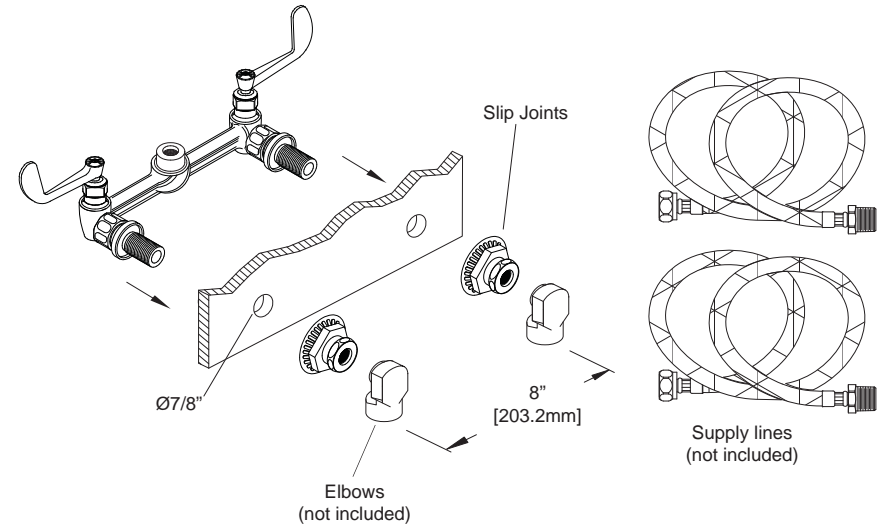

Step 3

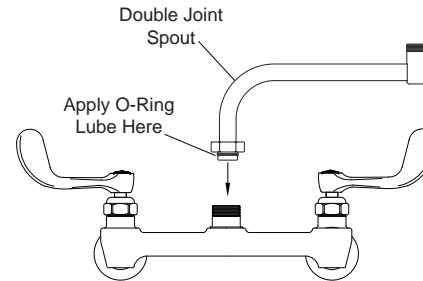

Step 4

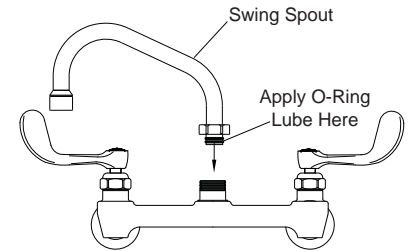

Step 5

