

# Replacement Parts for Backsplash Faucets



## 4" C/C Backsplash Faucet Product Installation Guide

Since 1936, Fisher Manufacturing Company has manufactured heavy-duty, high quality plumbing products and hardware specialties for the food service industry. For three generations, the Fisher family has adhered to a strict dedication of and overall value. When you install Fisher products... you install the best. Our hardware is manufactured with the standardization of internal mechanisms. All chrome plating is triple plated copper, nickel and chrome for durability. Every piece of equipment we make is rigorously tested in both our modern in-house testing center and in actual field situations under extreme conditions. Every detail is thoroughly checked. Before we make our products available to you, they pass each and every test. You get proven performance. Guaranteed.



### Limited One Year Warranty

Fisher Manufacturing Company warrants its products and parts thereof (except as noted below) against defects in materials or workmanship for a period of one year after the date of original purchase. During this period Fisher Manufacturing Company will replace a defective product or part without charge to you, provided that the entire product is delivered to Fisher Manufacturing Company. All transportation and insurance charges for shipping the product to and from Fisher Manufacturing Company must be borne by you. Charges for transportation and insurance may, at the option of Fisher Manufacturing Company, be refunded depending upon our investigation of the warranty claim. This warranty does not cover external finish (except at date of original purchase) or labor costs not specifically authorized by Fisher Manufacturing Company.

**#3616** - 4" c/c Backsplash Faucet with 12" Rigid Gooseneck Spout

**#2003** - 4" c/c Backsplash Faucet with 6" Rigid Gooseneck Spout

A full and complete copy of our One Year limited warranty is available upon request.

### WARNING:

*Proposition 65* requires that we provide you with the following notice: "This product Contains A Chemical Known To The State Of California To Cause Birth Defects Or Other Reproductive Harm."

**KEEP THIS MANUAL FOR FUTURE REFERENCE**



ANSI/A112.18.1M, ANSI/NSF 61.9

FISHER MANUFACTURING COMPANY - TOLL FREE: 800-421-6162 FAX: 800-832-8238

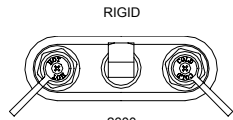

2600 CONTROL VALVE

10014 (24")  
10022 (36")  
SUPPLY LINE  
1/2" F X 1/2" F

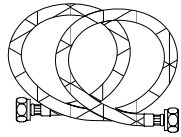

10049 (24")  
10006 (36")  
SUPPLY LINE  
1/2" M X 1/2" F

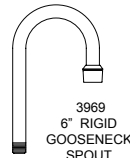
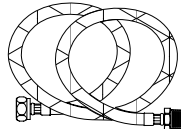

3969  
6" RIGID  
GOOSENECK  
SPOUT

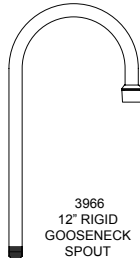

3966  
12" RIGID  
GOOSENECK  
SPOUT

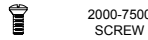

2000-7500  
SCREW

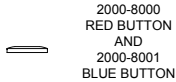

2000-8000  
RED BUTTON  
AND  
2000-8001  
BLUE BUTTON

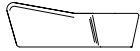

2000-2301  
LEVER HANDLE



2000-3002  
BIBB CAP

3000-0000  
RH SWIVEL STEM  
REPAIR KIT  
OR  
3000-0001  
LH SWIVEL STEM  
REPAIR KIT



10464  
DUCK GASKET



2000-5000  
WASHER

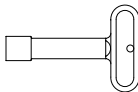
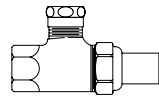

1792  
ANGLE STOP  
WITH KEY

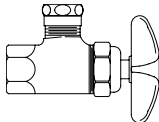

1790-1  
ANGLE STOP  
W/ CROSS  
HANDLE

3000-0010  
LH SWIVEL STEM  
OR  
3000-0011  
RH SWIVEL STEM

2000-5003  
SEAT WASHER



10456  
LUBE

1000-7502  
SCREW



2400-2103  
ELBOWS

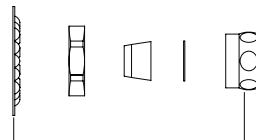

1000-8002  
SLIP JOINT KIT

**FISHER**  
MANUFACTURING COMPANY  
PO BOX 60, TULARE, CA 93275  
(800)421-6162, FAX: (800)832-8238  
www.fisher-mfg.com

# Installation Instructions for Backsplash Faucets

BE SURE TO CHECK WITH YOUR LOCAL DEPARTMENT HAVING JURISDICTION REGARDING BACKFLOW PREVENTION

## Installation Notes:

- Be sure to shut off water supply before beginning.
- Use pipe thread sealant such as PST on all threaded joints.
- Check the packaging for missing items BEFORE beginning installation. If items are missing, contact your supplier.

## Tools Required for Installation

- Medium Sized Crescent Wrench
- Pipe Thread Sealant



## Package Contents

The box should contain the following:

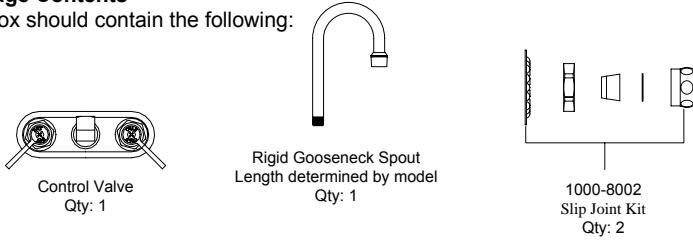

## Installation Instructions

1. Mount control valve body to the backsplash by inserting the nipples through the backsplash and attaching slip joints. Tighten the slip joints until the control valve is secure. Be sure to use pipe thread sealant on the nipple threads. Attach elbows and supply lines as needed. (not included)
2. Apply thread sealant to male threads on rigid spout and insert into control valve. Tighten until secure.
3. Turn on water supply and check for leaks.

### Step 1

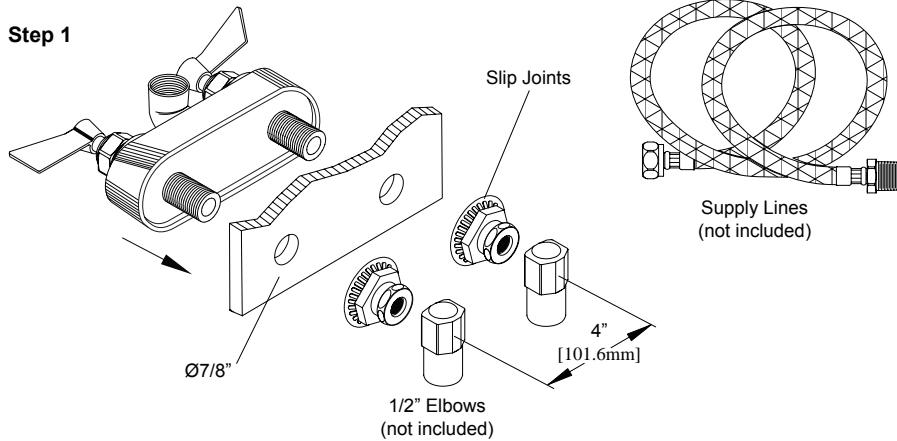

# Installation Instructions Continued

### Step 2

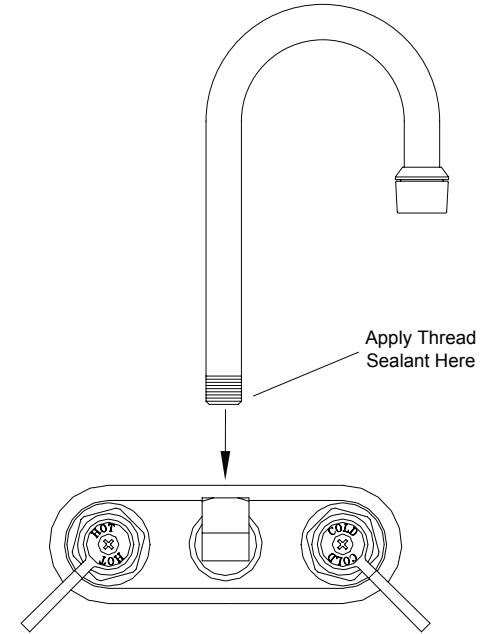

### Step 3

