



User's manual

ML17939

Two-line corded telephone/
answering system with
caller ID/call waiting



Congratulations

on purchasing your new AT&T product. Before using this AT&T product, please read **Important safety information** on page 68 of this user's manual. Please thoroughly read the user's manual for all the feature operations and troubleshooting information you need to install and operate your new AT&T product. You can also visit our website at **www.telephones.att.com** or call **1 (800) 222-3111**. In Canada, dial **1 (866) 288-4268**.

Model number: ML17939

Type: Two-line corded telephone/answering system with caller ID/call waiting

Serial number: _____

Purchase date: _____

Place of purchase: _____

Both the model and serial numbers of your AT&T product can be found on the bottom of the telephone base.



Telephones identified with this logo have reduced noise and interference when used with most T-coil equipped hearing aids and cochlear implants. The TIA-1083 Compliant Logo is a trademark of the Telecommunications Industry Association. Used under license.

Clearspeak® is a registered trademark of Advanced American Telephones.

© 2010-2016 Advanced American Telephones. All Rights Reserved. AT&T and the AT&T logo are trademarks of AT&T Intellectual Property licensed to Advanced American Telephones, San Antonio, TX 78219. Printed in China.

Parts checklist

Your telephone package contains the following items. Save your sales receipt and original packaging in the event warranty service is necessary.



Telephone base



Handset with coiled handset cord

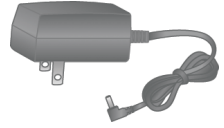

Power adapter

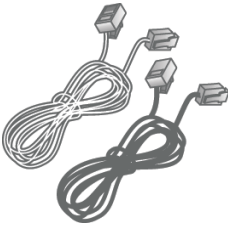

Telephone line cords: clear (2-conductor) and black (4-conductor)

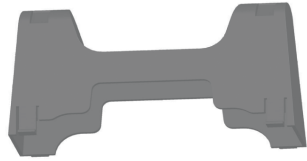

Mounting bracket

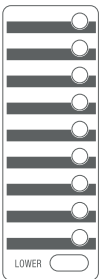

Replacement directory card

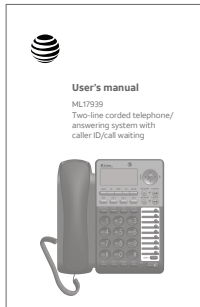

User's manual

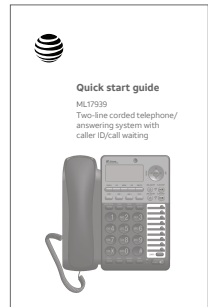

Quick start guide

User's manual

ML17939

Two-line corded telephone/
answering system with
caller ID/call waiting

Table of contents

Getting started

Quick reference guide.....	2
Optional backup battery installation.....	4
Telephone installation.....	5
Telephone base installation.....	5
Data port.....	8
Installation options.....	9
Tabletop to wall installation.....	9
Wall to tabletop installation.....	11
Optional headset.....	13
Directory card.....	13

Menu setup

Telephone settings.....	14
Menu overview.....	14
Ringer volume.....	15
Ringer melody.....	15
LCD language.....	16
LCD backlight.....	16
Date and time.....	16
Key tone.....	17
Scroll rate.....	17
Call settings.....	18
Set the primary line.....	18
Turn automatic line selection on or off.....	18
Turn auto speaker on or off.....	18
Choose the preferred mode.....	19
Set home and local area codes.....	19
Choose how to store repeat calls in the call history.....	20
Select tone or pulse dialing.....	20
Voicemail indicator settings.....	21
Voicemail indicator.....	21



Clear voicemail indicator.....	21
Turn COVM (central office voicemail) on or off.....	22

Telephone operation

Basic operation.....	23
Making, answering or ending a call.....	23
On hook dialing (predialing).....	24
Clearspeak® dial-in-base speakerphone.....	24
Switching between the handset, headset and speakerphone.....	24
Temporary ringer silencing.....	24
Redial.....	25
Auto redial.....	26
Options while on calls.....	27
Volume control.....	27
Flash/call waiting.....	27
Mute.....	27
Hold.....	27
Temporary tone dialing.....	28
Switching between lines.....	28
Conference calls.....	28
Two-way recording.....	29
Chain dialing.....	30

Speed dial

Speed dial memory overview.....	31
Speed dial operation.....	32
Storing a number in a speed dial location.....	32
Reviewing a speed dial number.....	32
Editing a speed dial number.....	33
Dialing a speed dial number.....	33
Deleting a speed dial number.....	34

Directory

Directory overview.....	35
Directory memory capacity.....	35
Character chart.....	35
Directory operation.....	36
Creating a directory entry.....	36
Reviewing directory entries.....	36
Searching by name.....	37
Editing directory entries.....	37
Copying directory entries to speed dial memory.....	38
Dialing directory entries.....	38
Deleting directory entries.....	38

Caller ID

About caller ID.....	39
Information about caller ID with call waiting.....	39
How caller ID history (call log) works.....	40
Caller ID operation.....	41
Memory match.....	41
Missed calls indicator.....	41
Reviewing call history.....	41
Dialing options.....	42
Dialing a call history entry.....	42
Deleting call history entries.....	42
Saving a call history entry to the directory.....	43
Saving a call history entry to a speed dial location.....	44
Reasons for missing caller ID information.....	45

Answering system settings

Answering system settings.....	46
Voice prompts.....	46
Announcement selection.....	46
Announcement A and B.....	47
Announcement A and B time settings.....	48
Answer on/off.....	49
Call screening.....	50
Number of rings.....	50
Incoming message length.....	51

Remote code.....	51
Priority code.....	52
Message alert tone.....	52

Answering system operation

Answering system and voicemail.....	53
Answering system operation.....	54
Message capacity.....	54
Answering system new message indication.....	54
Call screening.....	54
Call intercept.....	54
Priority code.....	54
Message playback.....	55
Options during playback.....	55
Delete all old messages.....	56
Record and play memos.....	56
Remote access.....	57

Appendix

Screen icons, indicator lights and alert tones.....	58
Indicator lights.....	58
Screen icons.....	58
Alert tones.....	59
Screen display messages.....	60
Troubleshooting.....	62
General product care.....	67
Important safety information.....	68
Safety information.....	68
Especially about corded telephones.....	68
For C-UL compliance.....	69
Mesures de sécurité importantes.....	69
FCC and ACTA information.....	71
Part 15 of FCC rules.....	73
Limited warranty.....	74
Technical specifications.....	76
Index	
Index.....	77

Installation preparation

You must install the power adapter before using the telephone.



See pages 6-7 for easy instructions.

If you subscribe to high speed Internet service (DSL - digital subscriber line) through your telephone line, you must install a DSL filter between each telephone line cord and telephone wall jack (pages 6 and 7). The filter prevents noise and caller ID problems caused by DSL interference. Please contact your DSL service provider for more information about DSL filters.

Your product may be shipped with a protective sticker covering the telephone base display - remove it before use.

For customer service or product information, visit our website at **www.telephones.att.com** or call **1 (800) 222-3111**. In Canada, dial **1 (866) 288-4268**.

Avoid placing the telephone base too close to:

- Communication devices such as television sets, VCRs, or cordless telephones.
- Excessive heat sources.
- Noise sources such as a window with traffic outside, motors, microwave ovens, refrigerators, or fluorescent lighting.
- Excessive dust sources such as a workshop or garage.
- Excessive moisture.
- Extremely low temperature.
- Mechanical vibration or shock such as on top of a washing machine or work bench.

Quick reference guide

DELETE

Press to delete the displayed directory, or call history entry (pages 38 and 42).

Press to backspace and erase a digit or character (pages 32 and 36).

During message playback, press to delete the message currently playing (page 55).

When the telephone is idle, press to delete all old messages (page 56).

DIR

Press to enter the directory (page 36).

MENU

Press to enter the main menu (page 14).

CID

Press to display call history information (page 41).

CANCEL

Press to cancel an operation and go back to the previous menu (page 14).

Press and hold to return to idle mode (page 14).

CONF

Press to initiate a three-way conference call (page 28).

LINE 1, LINE 2

Press to make or answer a call on the selected line (page 23).

ENTER

Press to select a menu item or to save a setting (page 14).

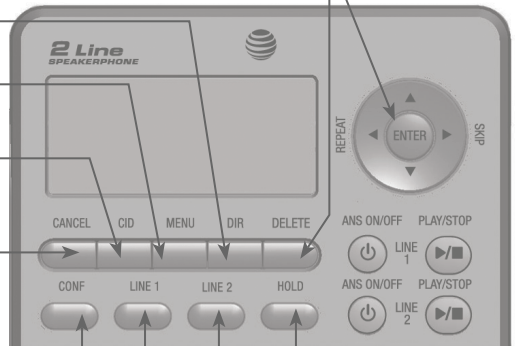

HOLD

Press to place a call on hold (page 27).

◀/REPEAT

While playing messages, press to repeat the message, or press twice to hear the previous message (page 55).

While entering names or numbers, press to move the cursor to the left (pages 32 and 36).

Press to go back to the previous menu (page 14).

⏻/ANS ON/OFF LINE1/LINE2

Press to turn the built-in answering system on or off (page 49).

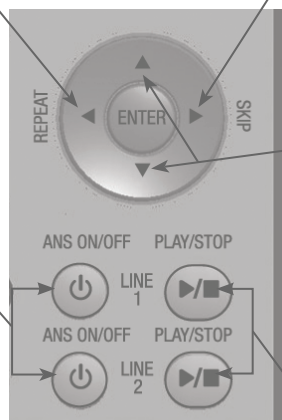

▶/SKIP

Press to skip to the next message (page 55).

While entering names or numbers, press to move the cursor to the right (pages 32 and 36).

▲/▼

While in the menu, press to scroll up or down (page 14).

While reviewing the directory or call history, press to scroll through entries or press and hold to scroll continuously (pages 36 and 41).

▶/■/PLAY/STOP LINE1/LINE2

Press to start or stop message playback (page 55).

Press to stop recording a memo (page 56).

Quick reference guide

FLASH

During a call, press to answer an incoming call when you receive a call waiting alert (page 27).

(AUTO) REDIAL

Press to dial the last number dialed when the telephone is off hook (page 26).

When the telephone is idle, press to display the last five numbers dialed. You can choose to dial a displayed number or use the auto redial feature (pages 25 and 26).

VOL+

While the telephone is not in use, press to increase the ringer volume for both lines (page 15).

During a call, press to increase the listening volume (page 27).

During message playback, press to increase the playback volume (page 55).

VOL-

While the telephone is not in use, press to decrease the ringer volume for both lines (page 15). During a call, press to decrease the listening volume (page 27).

During message playback, press to decrease the playback volume (page 55).

HEADSET

Press to activate the headset when a corded headset is connected (page 23).

MUTE

During a call, press to mute the microphone (page 27).

When a call is ringing, press to mute the ringer (page 24).

PAUSE

Press to insert a two-second dialing pause in a number stored in the directory or speed dial memory (pages 36 and 32).

DISP DIAL

Press to dial the number currently displayed (page 24).

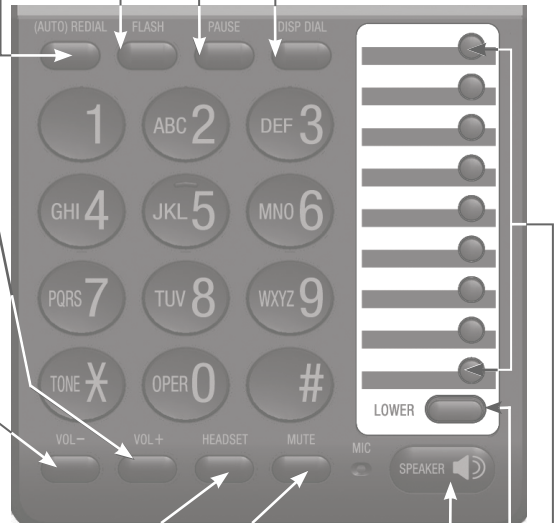

SPEAKER

Press to turn the base speakerphone on or off (page 23).

LOWER

Press to enter the lower locations of the speed dial keys (page 32).

Speed dial keys

Press to dial or review a stored speed dial number when the telephone is not in use (pages 32 and 33).

Optional backup battery installation

Install three AA alkaline batteries (purchased separately) to use this telephone in the event of a power failure. If power fails with working batteries installed, all functions work properly except for the display illumination.

If power fails and no batteries are installed, you can make or answer calls on line 1 using only the handset. Last number redial and speed dialing are also supported, but the screen display will be dimmer than usual.

Install the batteries, as shown below:

1. Press the tab and pull to remove the battery compartment cover. Insert three AA alkaline batteries (purchased separately) following the polarity markings in the battery compartment.

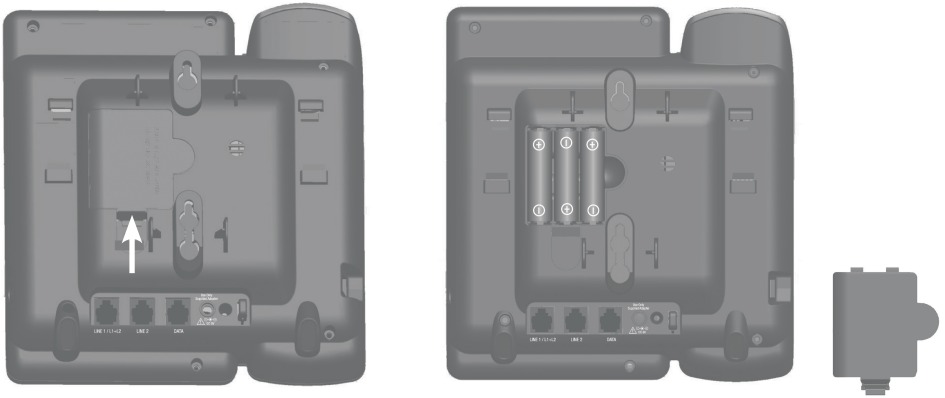

2. Replace the battery compartment cover.

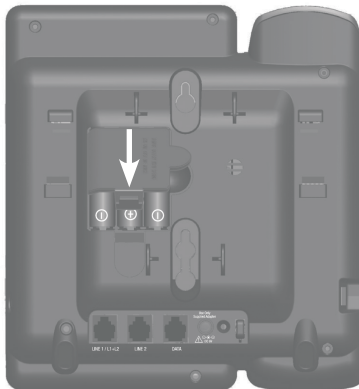

NOTE: If no backup batteries are installed and the power adapter is connected,  appears steady on the screen.

Telephone installation

Telephone base installation

1. Install the mounting bracket for tabletop use.

Option 1: To install your telephone in a low tabletop position, insert the fixed tabs of the mounting bracket into slots (a) and (b). Press the flexible tabs (A) and (B) into slots (c) and (d) until they click into place.

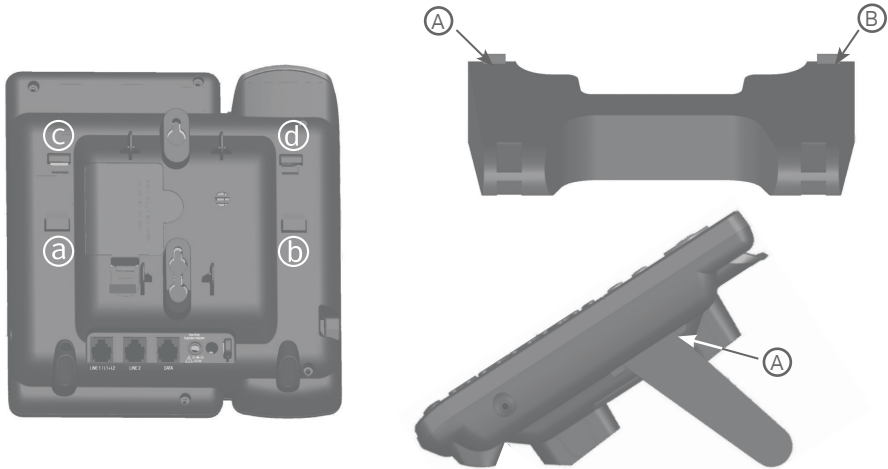

Option 1: Low tabletop position

Option 2: To install your telephone in a high tabletop position, insert the fixed tabs of the mounting bracket into slots (c) and (d). Press the flexible tabs (A) and (B) into slots (a) and (b) until they click into place.

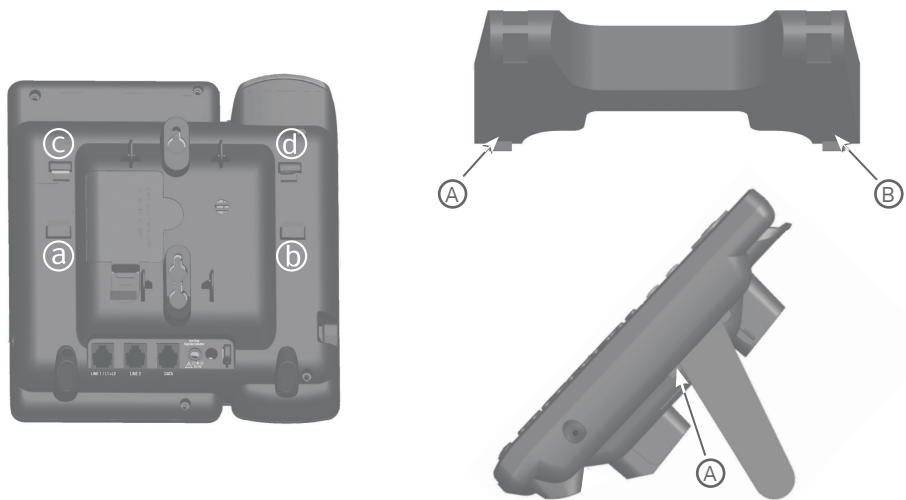

Option 2: High tabletop

Telephone installation

2. Connect the telephone line cord(s) and the power cord to the telephone base.

If you subscribe to high speed Internet service (DSL - digital subscriber line) through your telephone line, you must install a DSL filter between each telephone line cord and telephone wall jack. The filter prevents noise and caller ID problems caused by DSL interference. Please contact your DSL service provider for more information about DSL filters.

Option 1: If you have a two-line wall jack, install your telephone base, as shown below.

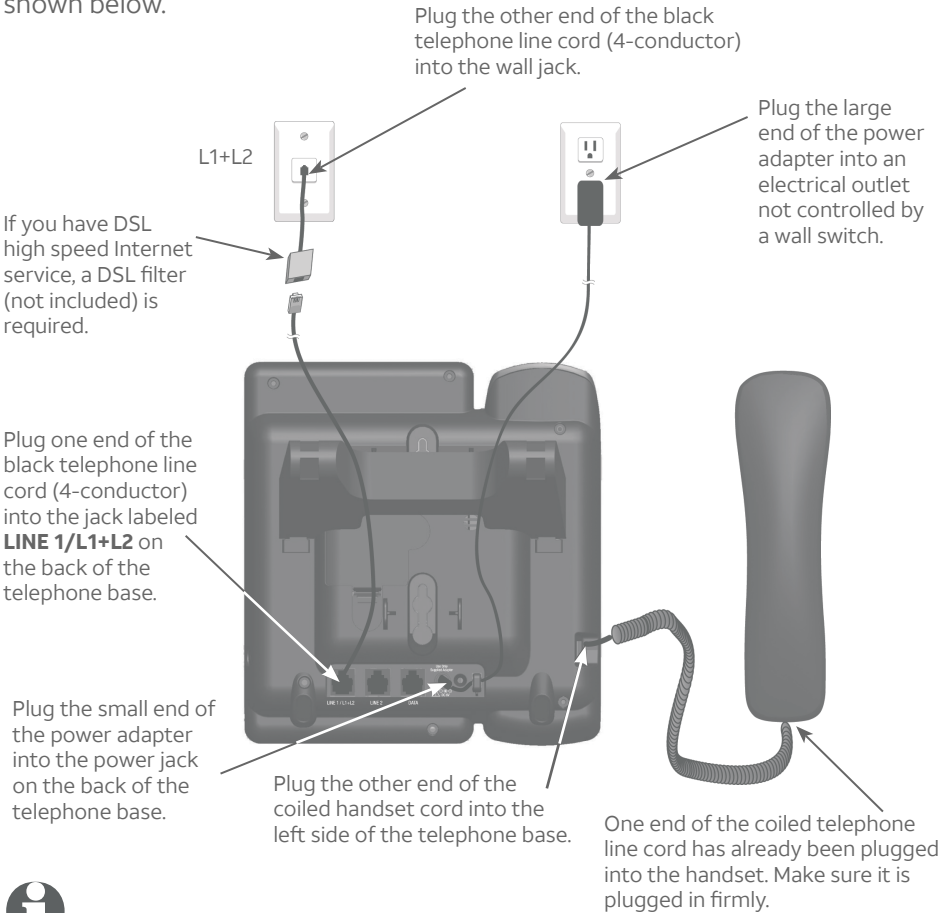

NOTES:

- Use only the power adapter supplied with this product. To order a replacement power adapter, visit our website at www.telephones.att.com, or call **1 (800) 222-3111**. In Canada, dial **1 (866) 288-4268**.
- The power adapter is intended to be correctly oriented in a vertical or floor mount position. The prongs are not designed to hold the plug in place if it is plugged into a ceiling, under-the-table or cabinet outlet.

Telephone installation

Option 2: If you have two one-line wall jacks, install your telephone base, as shown below.

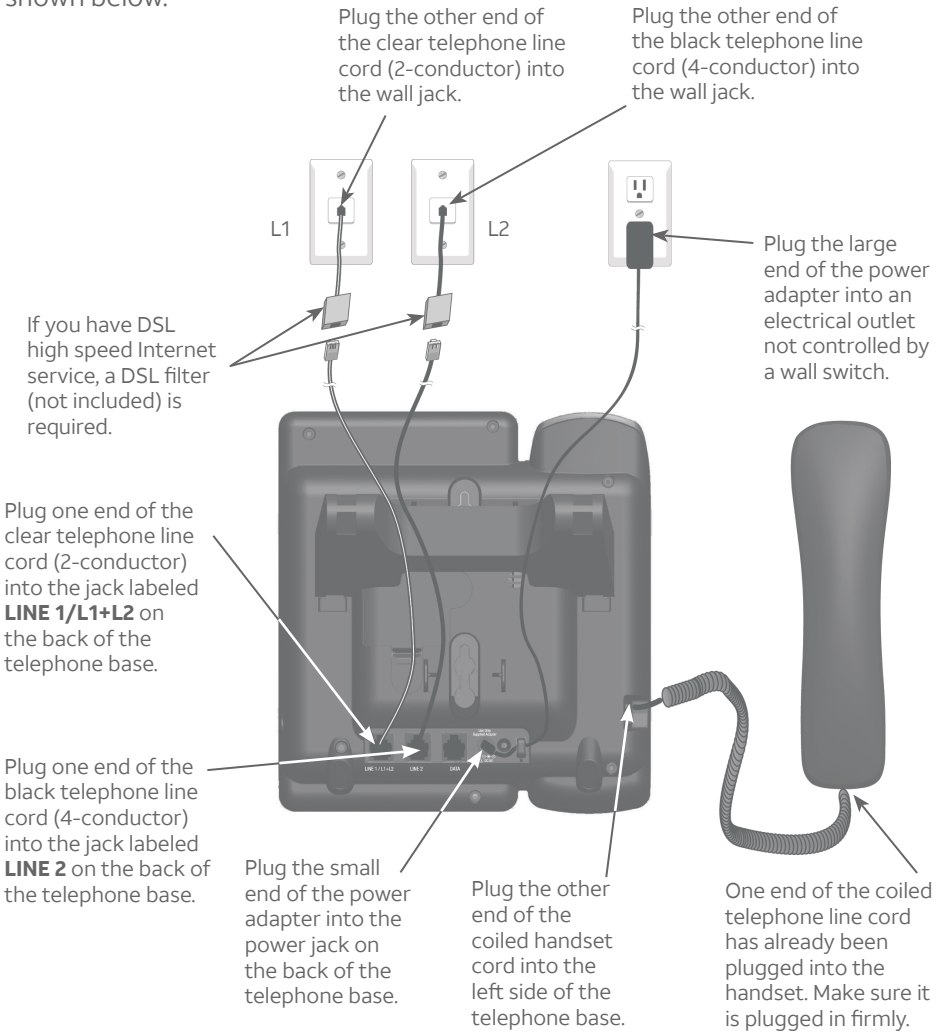

NOTES:

- Use only the power adapter supplied with this product. To order a replacement power adapter, visit our website at www.telephones.att.com, or call **1 (800) 222-3111**. In Canada, dial **1 (866) 288-4268**.
- The power adapter is intended to be correctly oriented in a vertical or floor mount position. The prongs are not designed to hold the plug in place if it is plugged into a ceiling, under-the-table or cabinet outlet.

Data port

If you want to connect another device (such as a modem or fax machine) to the wall jack, use the port labeled **DATA** on the back of the telephone base. The data port uses line 2 only.

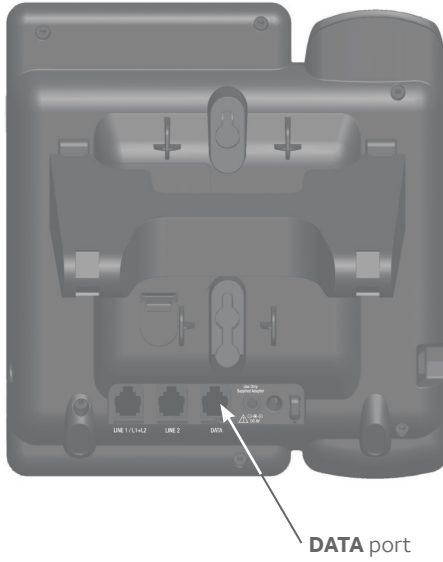

Installation options

If you want to mount your telephone on a wall, connect the telephone base to a standard dual-stud telephone wall-mounting plate. If you do not have this mounting plate, you can purchase one from many hardware or consumer electronics retailers. Professional assistance may be required to install the mounting plate.

Tabletop to wall installation

To install your telephone base in the wall installation position, make sure you first unplug the power adapter from the electrical outlet and the telephone line cord from the wall outlet.

1. Hold down the switch hook on the telephone base, then slide the handset tab upwards to remove it from the slot. Rotate the handset tab 180 degrees, then push the handset tab down into the slot until it locks into position.

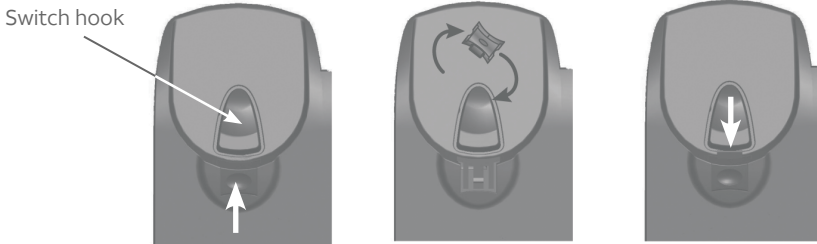

2. Depending on whether the mounting bracket is in low or high tabletop position, press in the direction indicated by the arrows to release and remove the mounting bracket from the telephone base.

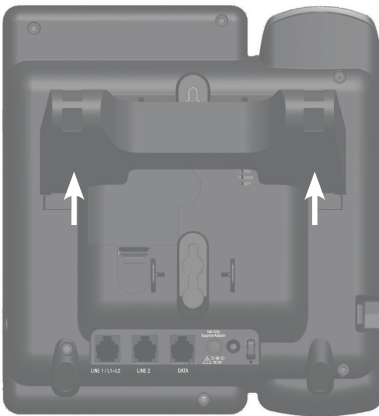

Option 1: Low tabletop position

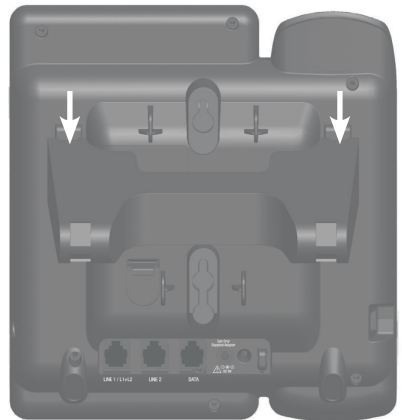

Option 2: High tabletop position

Installation options

3. Plug the coiled handset cord into the handset and the telephone base. Plug the small end of the power adapter cord into the power jack on the back of the telephone base.

4. Plug the telephone line cords into the wall jacks.

Option 1: If you have a single two-line wall jack, use only the black telephone line cord (4-conductor).

Plug one end of the black telephone line cord into the jack labeled **LINE 1/L1+L2** on the back of the telephone base. Plug the large end of the power adapter into an electrical outlet not controlled by a wall switch.

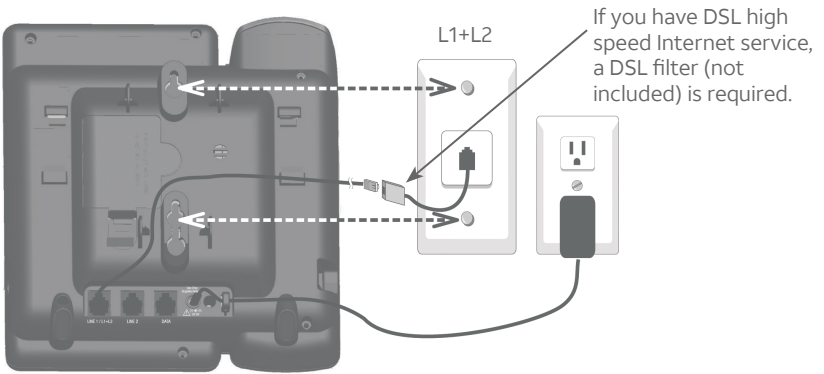

Option 2: If you have two separate one-line wall jacks, use both telephone line cords.

Plug one end of the clear telephone line cord into the jack labeled **LINE 1/L1+L2** on the back of the telephone base. Plug one end of the black telephone line cord into the jack labeled **LINE 2**. Plug the other end of the clear telephone line cord and the other end of the black telephone line cord into the wall jacks.

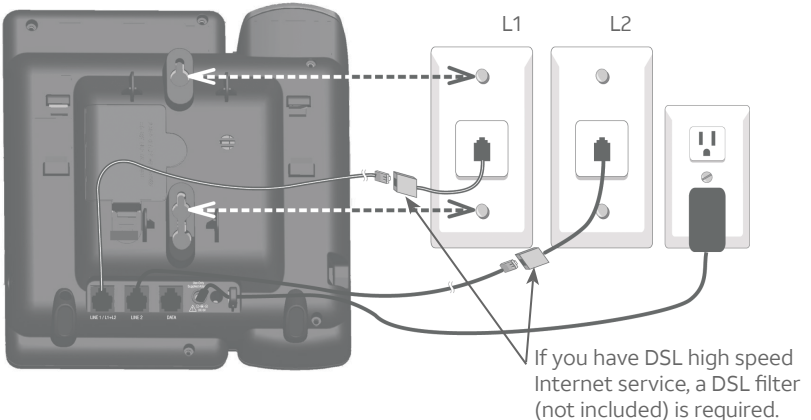

Installation options

5. Wrap the telephone line cord, as shown below. Mount the telephone on the mounting plate until it is held securely into position. Plug the large end of the power adapter into an electrical outlet not controlled by a wall switch.

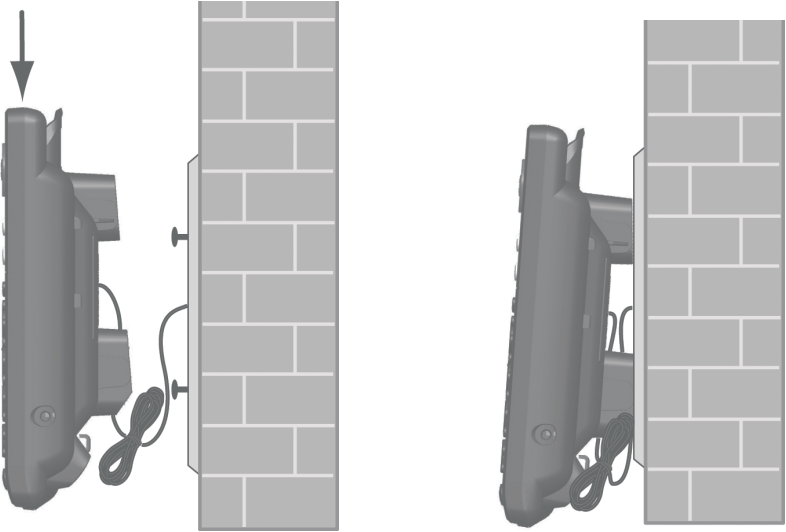

Wall to tabletop installation

To return the telephone base from wall installation to tabletop position:

1. Unwrap the telephone line cord. Remove the telephone base from the wall. Unplug the telephone line cord from the telephone wall jack and the power adapter cord from the electrical outlet.

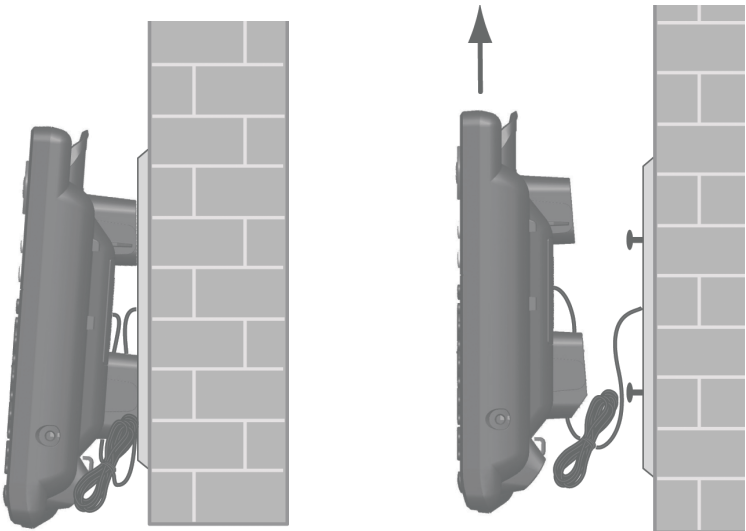

Installation options

2. Hold down the switch hook on the telephone base, then slide the handset tab upwards to remove it from the slot. Rotate the handset tab 180 degrees, then push the handset tab down into the slot until it locks into position.

Switch hook

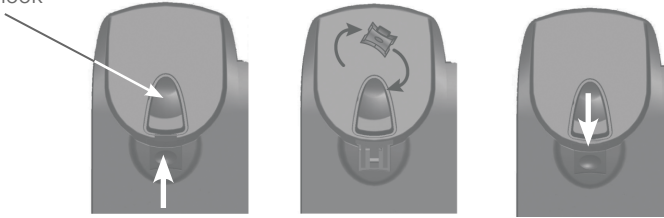

3. Follow the steps in **Telephone base installation** on pages 5-7 to install your telephone for tabletop use.

Optional headset

You can use this telephone hands free when you install any industry standard 2.5mm corded telephone headset (purchased separately). The telephone plays an error tone if you press **HEADSET** when a headset is not plugged into the headset jack.

For best results, use an AT&T 2.5mm headset. To order an AT&T 2.5mm headset, visit our website at **www.telephones.att.com** or call **1 (800) 222-3111**. In Canada, dial **1 (866) 288-4268**.

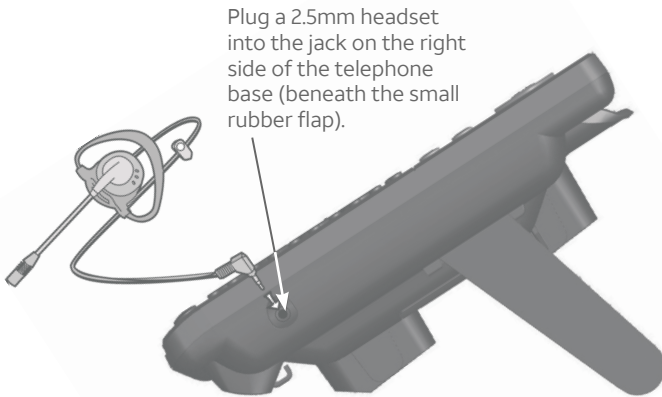

Directory card

Use the directory card to record the names of the speed dial numbers you stored.

To write names on the directory card:

1. Remove the clear plastic cover by inserting the tip of a small item, such as a paper clip, into the hole at the top edge of the cover.
2. Pull out the directory card.
3. Write the information on the directory card.
4. Replace the directory card and the plastic cover.

To change the directory card:

1. Follow Steps 1 and 2, as mentioned above, to remove the old directory card.
2. Insert the new directory card and replace the plastic cover.



Telephone settings

Menu overview

Use the menus to change the telephone settings.

1. When the telephone is idle, press **MENU** to enter the main menu.
2. Press **▲** or **▼** to scroll to the feature to be changed. Press **ENTER**.
3. Press **▲** or **▼** to scroll to the desired settings.
4. Press **ENTER** to save your selection. The telephone plays a confirmation tone and returns to the previous menu. Press **◀/REPEAT** to go back to the previous menu. To exit without making changes, press **CANCEL**.

-OR-

Press and hold **CANCEL** to return to idle mode.



NOTE: If no key is pressed within 30 seconds, the telephone automatically returns to idle mode.

Menu structure

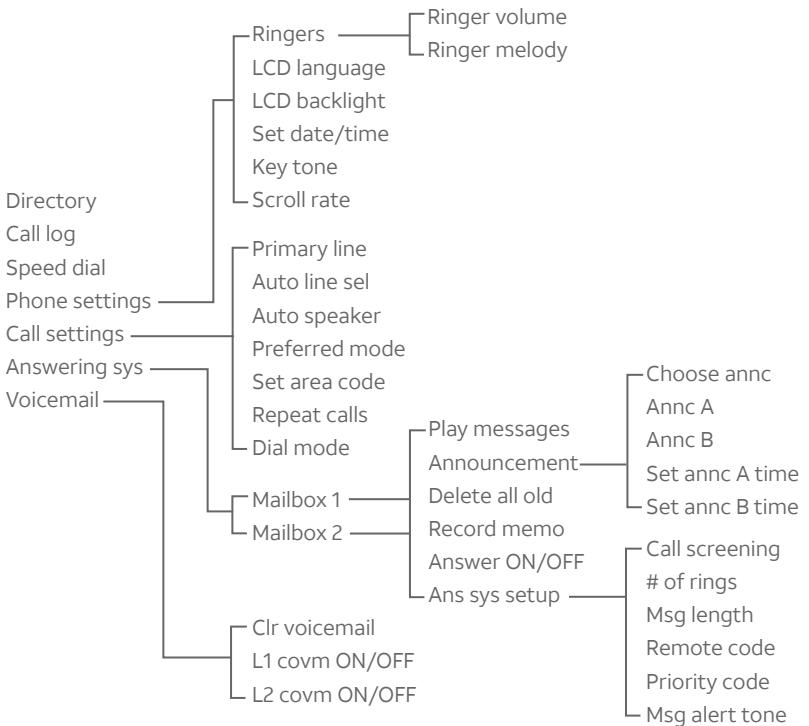

Telephone settings

Ringer volume

You can set the ringer volume level (1-6) or turn the ringer off. When the ringer is off, **Ringer muted** appears on the screen.

1. When the telephone is idle, press **MENU**.
2. Press **▲** or **▼** to scroll to **Phone settings**. Press **ENTER**.
3. Press **▲** or **▼** to scroll to **Ringers**. Press **ENTER**.
4. Press **▲** or **▼** to scroll to **Ringer volume**. Press **ENTER**.
5. Press **▲** or **▼** to select the desired line (**Line 1**, **Line 2** or **Lines 1 & 2**). Press **ENTER**.
6. Press **▲**, **▼**, **VOL+** or **VOL-** to adjust the ringer volume for the selected line.
7. Press **ENTER** to save your setting. The telephone plays a confirmation tone and returns to the previous menu.

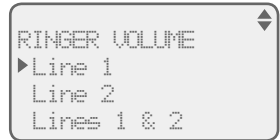
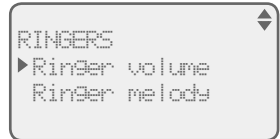
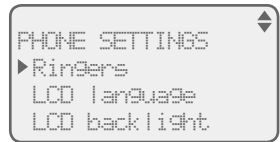

NOTES:

- Pressing **VOL+** or **VOL-** when the telephone is idle adjusts the ringer volume for both lines.
- If the ringer for one or both lines is muted,  for the corresponding line or both lines flashes on the screen when the telephone is idle or there is an incoming call.

Ringer melody

Use this feature to choose one of the 10 ringer melodies for incoming calls. You can choose different ringer melodies for each line or the same ringer melody for both lines.

1. When the telephone is idle, press **MENU**.
2. Press **▲** or **▼** to scroll to **Phone settings**. Press **ENTER**.
3. Press **▲** or **▼** to scroll to **Ringers**. Press **ENTER**.
4. Press **▲** or **▼** to scroll to **Ringer melody**. Press **ENTER**.
5. Press **▲** or **▼** to select the desired line (**Line 1**, **Line 2** or **Lines 1 & 2**). Press **ENTER**.
6. Press **▲** or **▼** to select the desired ringer melody. The telephone plays each ringer melody as you scroll through the choices.
7. Press **ENTER** to save your selection. The telephone plays a confirmation tone and returns to the previous menu.

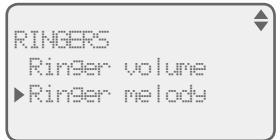

NOTE: If you turn off the ringer volume, you do not hear the ringer melody samples.

Telephone settings

LCD language

Use this feature to change the display language that is used in all menus and screens. This telephone uses **English** for display by default.

1. When the telephone is idle, press **MENU**.
2. Press **▲** or **▼** to scroll to **Phone settings**. Press **ENTER**.
3. Press **▲** or **▼** to scroll to **LCD language**. Press **ENTER**.
4. Press **▲** or **▼** to select **English, Français** or **Español**.
5. Press **ENTER** to save your selection. The telephone plays a confirmation tone and returns to the previous menu.

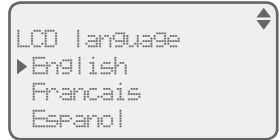

LCD backlight

Use this feature to turn the LCD backlight on or off.

1. When the telephone is idle, press **MENU**.
2. Press **▲** or **▼** to scroll to **Phone settings**. Press **ENTER**.
3. Press **▲** or **▼** to scroll to **LCD backlight**. Press **ENTER**.
4. Press **▲** or **▼** to select **On** or **Off**.
5. Press **ENTER** to save your selection. The telephone plays a confirmation tone and returns to the previous menu.



Date and time

The telephone plays the date and time that a message was received by the answering system. If you subscribe to a caller ID service provided by your telephone service provider, the date and time are set automatically with each incoming call. The year must be set so that the day of the week can be calculated from the caller ID information. Before using the answering system, set the date and time as follows.

1. When the telephone is idle, press **MENU**.
2. Press **▲** or **▼** to scroll to **Phone settings**. Press **ENTER**.
3. Press **▲** or **▼** to scroll to **Set date/time**. Press **ENTER** to set the date.
4. Use the dialing keys to enter the date. To enter a number that is less than 10, enter a 0 before the digit. Press **◀/REPEAT** or **▶/SKIP** to move the cursor to the left or right.

-OR-

Press **▲** or **▼** to scroll to the desired digit. Press **ENTER** to move on to set the next digit. Press **◀/REPEAT** or **▶/SKIP** to move the cursor to the left or right.

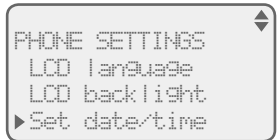

Telephone settings

- Press **ENTER** to move to the time setting.
- Use the dialing keys to enter the time. To enter a number that is less than 10, **you have to enter a 0** before the digit. Press **◀/REPEAT** or **▶/SKIP** to move the cursor to the left or right.



-OR-

Press **▲** or **▼** to scroll to the desired digit. Press **ENTER** to move on to set the next digit. Press **◀/REPEAT** or **▶/SKIP** to move the cursor to the left or right.

- Press **▲** or **▼** to select **AM** or **PM**.
- Press **ENTER** to save the setting. The telephone plays a confirmation tone and returns to the previous menu.



NOTE: The telephone plays an error tone if you enter an invalid date or time.

Key tone

Use this feature to turn the key tone on or off. The telephone is set to beep with every key press by default.

- When the telephone is idle, press **MENU**.
- Press **▲** or **▼** to scroll to **Phone settings**. Press **ENTER**.
- Press **▲** or **▼** to scroll to **Key tone**. Press **ENTER**.
- Press **▲** or **▼** to select **On** or **Off**.
- Press **ENTER** to save your selection. The telephone plays a confirmation tone and returns to the previous menu.

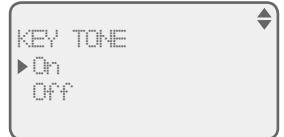
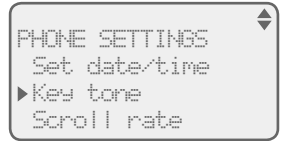

Scroll rate

Use this feature to set the scroll rate when you press and hold **▲** or **▼** to scroll through entries in the directory or call history.

- When the telephone is idle, press **MENU**.
- Press **▲** or **▼** to scroll to **Phone settings**. Press **ENTER**.
- Press **▲** or **▼** to scroll to **Scroll rate**. Press **ENTER**.
- Press **▲** or **▼** to select **Slow**, **Medium** or **Fast**.
- Press **ENTER** to save your selection. The telephone plays a confirmation tone and returns to the previous menu.

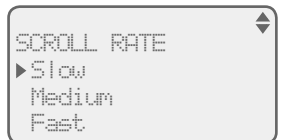
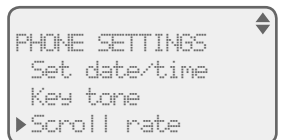

Call settings

Set the primary line

Use this feature to select the default telephone line to be used when you make calls. The primary line is set to **Line 1** by default.

1. When the telephone is idle, press **MENU**.
2. Press **▲** or **▼** to scroll to **Call settings**. Press **ENTER**.
3. Press **▲** or **▼** to scroll to **Primary line**. Press **ENTER**.
4. Press **▲** or **▼** to select **Line 1** or **Line 2**.
5. Press **ENTER** to save your selection. The telephone plays a confirmation tone and returns to the previous menu.

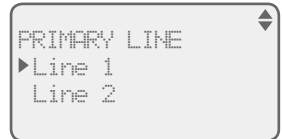
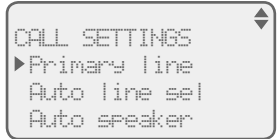

Turn automatic line selection on or off

When **Auto line sel** is turned on and both telephone lines are connected, the telephone automatically selects the first available line to use when making a call. The **Auto line sel** feature is set to **On** by default. To change the setting:

1. When the telephone is idle, press **MENU**.
2. Press **▲** or **▼** to scroll to **Call settings**. Press **ENTER**.
3. Press **▲** or **▼** to scroll to **Auto line sel**. Press **ENTER**.
4. Press **▲** or **▼** to select **On** or **Off**.
5. Press **ENTER** to save your selection. The telephone plays a confirmation tone and returns to the previous menu.

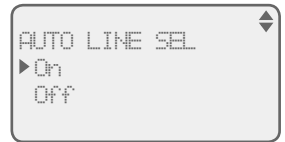
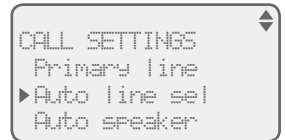

NOTE: If only one line is connected and not set as the primary line, you will need to press the **LINE** button before making a call.

Turn auto speaker on or off

If **Auto speaker** is turned **On**, when you press a speed dial key with a stored number, the telephone automatically dials the number using the preferred mode you set (see **Choose the preferred mode** on page 19). The **Auto speaker** feature is set to **Off** by default. To change the setting:

1. When the telephone is idle, press **MENU**.
2. Press **▲** or **▼** to scroll to **Call settings**. Press **ENTER**.
3. Press **▲** or **▼** to scroll to **Auto speaker**. Press **ENTER**.
4. Press **▲** or **▼** to select **On** or **Off**.
5. Press **ENTER** to save your selection. The telephone plays a confirmation tone and returns to the previous menu.

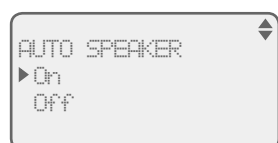
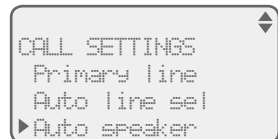

Call settings

Choose the preferred mode

You can set the **Preferred mode** to speakerphone or headset. Your selection is used automatically when dialing a number from the directory, redial or call history without lifting the handset. Your selection is also used for speed dialing when auto speaker is set to **On** (see **Turn auto speaker on or off** on page 18). If a corded headset is not plugged in, the speakerphone is used automatically. The **Preferred mode** is set to **Speakerphone** by default. To change the setting:

1. When the telephone is idle, press **MENU**.
2. Press **▲** or **▼** to scroll to **Call settings**. Press **ENTER**.
3. Press **▲** or **▼** to scroll to **Preferred mode**. Press **ENTER**.
4. Press **▲** or **▼** to select **Speakerphone** or **Headset**.
5. Press **ENTER** to save your selection. The telephone plays a confirmation tone and returns to the previous menu.

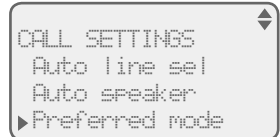

Set home and local area codes

If you dial seven digits to make a local call (no area code required), enter your area code into the telephone as the home area code. When you receive a call from within your home area code, the caller ID history only displays the seven digits of the telephone number, and when you dial from the caller ID history, only seven digits are dialed.

This feature makes it easy for you to place a call from the caller ID history. If you must dial 10 digits (area code + telephone number) to make a local call, do not program the home area code. Then, if you receive a call from within your area code, the screen displays the 10 digits of the telephone number, and when you dial from the caller ID history, all 10 digits will be dialed.

1. When the telephone is idle, press **MENU**.
2. Press **▲** or **▼** to scroll to **Call settings**. Press **ENTER**.
3. Press **▲** or **▼** to scroll to **Set area code**. Press **ENTER**.
4. Press **▲** or **▼** to scroll to **Home area code** or **Loc area code 1 - Loc area code 4**. Press **ENTER**.
5. Use the dialing keys to enter a three-digit area code.
 - Press **◀/REPEAT** or **▶/SKIP** to scroll to the digit you wish to edit.
 - Press **DELETE** to backspace and delete a digit.
6. Press **ENTER** to save your setting. The telephone plays a confirmation tone and returns to the previous menu.

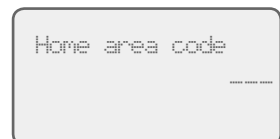
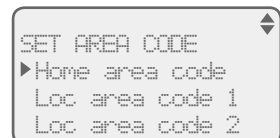
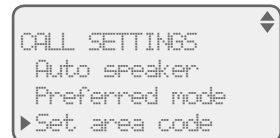

Call settings

Choose how to store repeat calls in the call history

Use this feature to choose how new calls from the same number are displayed in the call history. If you want to store only the last call of repeated calls, select **Combined**. If you want to store all incoming calls separately, select **Separate**. The default setting is **Separate**.

1. When the telephone is idle, press **MENU**.
2. Press **▲** or **▼** to scroll to **Call settings**. Press **ENTER**.
3. Press **▲** or **▼** to scroll to **Repeat calls**. Press **ENTER**.
4. Press **▲** or **▼** to select **Combined** or **Separate**.
5. Press **ENTER** to save your selection. The telephone plays a confirmation tone and returns to the previous menu.

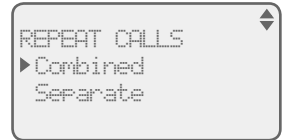
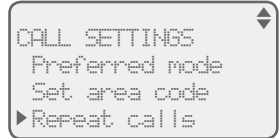

Select tone or pulse dialing

You can choose tone or pulse dialing in this menu. The default setting is **Tone**. Change this to **Pulse** (rotary) only if you do not have touch-tone dialing service.

1. When the telephone is idle, press **MENU**.
2. Press **▲** or **▼** to scroll to **Call settings**. Press **ENTER**.
3. Press **▲** or **▼** to scroll to **Dial mode**. Press **ENTER**.
4. Press **▲** or **▼** to select **Tone** or **Pulse**.
5. Press **ENTER** to save your selection. The telephone plays a confirmation tone and returns to the previous menu.

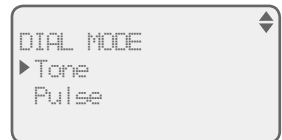
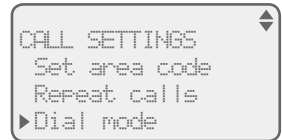

Voicemail indicator settings

Voicemail indicator

If you subscribe to voicemail service offered by your telephone service provider, this feature provides a visual indication when you have new voicemail messages on either line. **Voicemail** displays and the corresponding line blinks on the screen to indicate there are new voicemail messages on that line.



```
L2: 12 Missed
Voicemail: L1 L2
8:00am 1/11
```



NOTE: This feature does not indicate new answering system messages recorded on your telephone answering system. For more information about the difference between the answering system and voicemail, see page 53.

Clear voicemail indicator

After you have listened to all new voicemail messages, the indicators turn off automatically.

Use the clear voicemail feature when the telephone indicates that there is new voicemail when there is none (for example, when you have accessed your voicemail while away from home). The clear voicemail feature only turns off the indicators; it does not delete your voicemail messages. As long as you have new voicemail messages, your telephone service provider continues to send the signal that turns on the indicator.

To manually turn off the indicator, follow the steps.

1. When the telephone is idle, press **MENU**.
2. Press **▲** or **▼** to scroll to **Voicemail**.
Press **ENTER**.
3. Press **▲** or **▼** to scroll to **Clr voicemail**.
Press **ENTER**.
4. Press **▲** or **▼** to select **Line 1**, **Line 2** or **Lines 1 & 2**.
5. Press **ENTER** to save your selection. The screen displays **VM indicator cleared** and then returns to the previous menu.

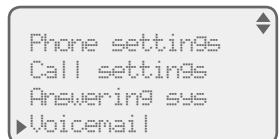

```
Phone settings
Call settings
Answering sys
▶ Voicemail
```

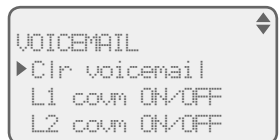

```
VOICEMAIL
▶ Clr voicemail
L1 covm ON/OFF
L2 covm ON/OFF
```

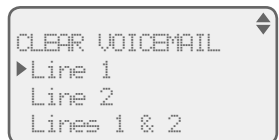

```
CLEAR VOICEMAIL
▶ Line 1
Line 2
Lines 1 & 2
```

Voicemail indicator settings

Turn **COVM (central office voicemail) on or off**

If you subscribe to voicemail service on any line with your telephone service provider, turn on the **COVM** feature for that telephone line. If you do not subscribe to voicemail service or want to disable the indicator, turn the **COVM** feature off.

1. When the telephone is idle, press **MENU**.
2. Press **▲** or **▼** to scroll to **Voicemail**.
Press **ENTER**.
3. Press **▲** or **▼** to select **L1 covm ON/OFF** or **L2 covm ON/OFF**. Press **ENTER**.
4. Press **▲** or **▼** to scroll to **On** or **Off**.
5. Press **ENTER** to save your selection. The telephone plays a confirmation tone and returns to the previous menu.

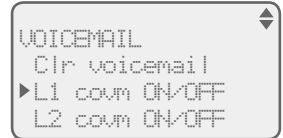
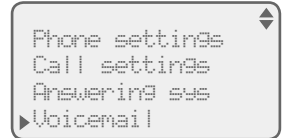

Basic operation

The telephone is set to use line 1 by default for making calls. To change the primary line, see **Set the primary line** on page 18. When you answer a call, the telephone automatically selects the ringing line.

Making, answering or ending a call

To make a call with the speakerphone:

1. Press **SPEAKER**  to use the primary line.

-OR-

To override automatic line selection, press **SPEAKER** , then press **LINE 1** or **LINE 2**.

-OR-

If you chose **Speakerphone** in **Choose the preferred mode** (see page 19), press **LINE 1** or **LINE 2** directly to activate the speakerphone.

2. Wait for a dial tone, then dial the telephone number. The screen displays the elapsed time as you talk (in hours, minutes and seconds).
3. Press **SPEAKER**  to hang up.

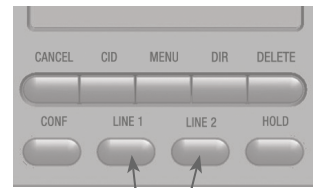
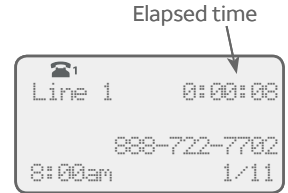

LINE buttons

To make a call with the handset:

1. Lift the handset to use the primary line.

-OR-

Lift the handset, then press **LINE 1** or **LINE 2** to override automatic line selection.

2. Wait for a dial tone, then dial the number.
3. Place the handset on the telephone base to hang up.

To make a call with the corded headset:

Make sure the corded headset is connected to the telephone base (see page 13).

1. Press **HEADSET** on the telephone base to use the primary line.

-OR-

Press **HEADSET**, then press **LINE 1** or **LINE 2** to override automatic line selection.

-OR-

If you choose **Headset** in **Choose the preferred mode** (see page 19), press **LINE 1** or **LINE 2** directly to activate the headset.

2. Wait for a dial tone, then dial the number.
3. Press **HEADSET** to hang up.

To answer a call:

- Lift the handset, then press **SPEAKER**  or **HEADSET**.

Basic operation

-OR-

Press the **LINE** button of the ringing line to answer the call with the preferred mode (see **Choose the preferred mode** on page 19).

On hook dialing (predialing)

1. Use the dialing keys to enter a telephone number. Press **DELETE** to make corrections when entering the telephone number.
2. Lift the handset or press **SPEAKER**  or **HEADSET**.

-OR-

To dial the number using your preferred mode (see **Choose the preferred mode** on page 19):

- Press **DISP DIAL**.
- Press **LINE 1** or **LINE 2** to override automatic line selection.

Clearspeak® dial-in-base speakerphone

During a call, press **SPEAKER** , then hang up the handset. This allows you to use the telephone hands free and lets more people participate in the conversation.

Switching between the handset, headset and speakerphone

To switch from the handset to speakerphone:

While you are on a call using the handset, press **SPEAKER** , then hang up the handset.

To switch from the handset to headset:

While you are on a call using the handset, press **HEADSET** (make sure a headset is firmly plugged in), then hang up the handset.

To switch from the speakerphone to handset:

While you are on a call using the speakerphone, lift the handset.

To switch from the speakerphone to headset:

While you are on a call using the speakerphone, press **HEADSET** (make sure a headset is firmly plugged in).

To switch from the headset to speakerphone:

While you are on a call using the headset, press **SPEAKER** .

To switch from the headset to handset:

While you are on a call using the headset, lift the handset.

Temporary ringer silencing

When the telephone is ringing, press **MUTE** to temporarily silence the ringing line. **Ringer muted** and  display on the screen for that line. This turns off the ringer without disconnecting the call. The next incoming call rings normally.

Basic operation

Redial

The last five telephone numbers dialed (up to 32 digits) are stored in the redial memory.

To dial one of the five most recently dialed numbers:

1. When the telephone is idle, press **(AUTO) REDIAL** to enter the redial list and display the most recently called numbers.
2. Press ▲ or ▼ to scroll to the desired number.
3. Lift the handset or press **SPEAKER**  or **HEADSET**.

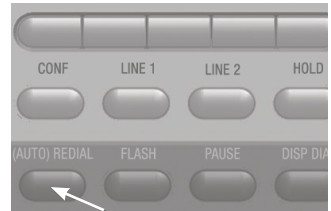

-OR-

To dial the number using your preferred mode (see **Choose the preferred mode** on page 19):

- Press **ENTER** or **DISP DIAL**.
- Press **LINE 1** or **LINE 2** to override automatic line selection.

To dial the last number dialed:

1. Lift the handset or press **SPEAKER**  or **HEADSET**.

-OR-

Press **LINE 1** or **LINE 2** to override automatic line selection.

2. Press **(AUTO) REDIAL** to dial the last number dialed.

To copy a redial entry (up to 24 digits) into the speed dial memory:

1. When the telephone is idle, press **(AUTO) REDIAL** to enter the redial list and display the most recently called numbers.
2. Press ▲ or ▼ to scroll to the desired number.
3. Press ◀/REPEAT or ▶/SKIP to select **Copy to SpDial**.
4. Press **ENTER**. The telephone displays **Press speed dial key**.
5. Press a speed dial key, or **LOWER**, then a speed dial key. The entry is saved into the location.

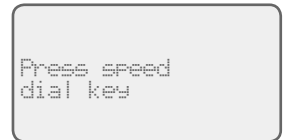
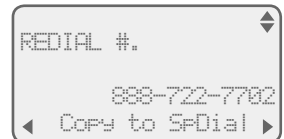

NOTES:

- If the redial entry you saved into the speed dial memory is over 24 digits, the screen shows **Only 24 digits are allowed**.
- If the number you dialed is over 32 digits, only the first 32 digits are saved in the redial.

Basic operation

To delete a redial entry:

1. When the telephone is idle, press **(AUTO) REDIAL** to enter the redial list and display the most recently called numbers.
2. Press ▲ or ▼ to scroll to the desired number.
3. Press **DELETE** to delete the displayed entry.

-OR-

Press ◀/REPEAT or ▶/SKIP to scroll to **Delete**.

Press **ENTER**. The entry is deleted. Once an entry is deleted, it cannot be retrieved.



NOTE: If there is no number stored in the redial list when you press **(AUTO) REDIAL**, there is an error tone.

Auto redial

The telephone will automatically redial a number up to 2 times if no one answers the call, or up to 10 times if the number you dialed is busy. If the number dialed is busy, the telephone will disconnect and redial the number after 30 seconds.

To auto redial a number on the redial list:

1. When the telephone is idle, press **(AUTO) REDIAL** to enter the redial list and display the most recently called numbers.
2. Press ▲ or ▼ to scroll to the desired number.
3. Press ◀/REPEAT or ▶/SKIP to scroll to **Auto redial**.
4. Press **ENTER**. The telephone automatically dials the number. The **(AUTO) REDIAL** indicator light flashes, and the **SPEAKER** 🔊 or **HEADSET** indicator light also flashes according to the preferred mode setting (see **Choose the preferred mode** on page 19).
5. When the other party answers the call, lift the handset or press **SPEAKER** 🔊 or **HEADSET** to speak with the other party.

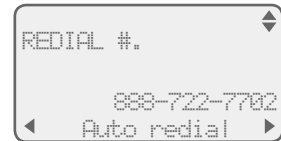

To cancel auto redial at any time:

- Press **(AUTO) REDIAL**.

-OR-

Lift the handset.

-OR-

Press **SPEAKER** 🔊 or **HEADSET**.

-OR-

Press any dialing key.

Options while on calls

Volume control

When you are on a call, press **VOL+** to increase the handset, speakerphone or headset listening volume. Press **VOL-** to decrease the listening volume. There are two beeps when you reach the minimum or maximum level.

Flash/call waiting

If you subscribe to call waiting service from your telephone service provider (see **About caller ID** on pages 39–40), and someone calls while you are already on a call, you hear two beeps.

- Press **FLASH** to put your current call on hold and take the new call.
- Press **FLASH** at any time to switch back and forth between calls.

Mute

Use this feature during a telephone conversation to silence the microphone. You can hear the other party, but the other party cannot hear you.

To mute a call:

- During a call, press **MUTE**. When mute is on, the **MUTE** light turns on and the screen displays **Microphone off**.

To take a call off mute:

- Press **MUTE** again and resume speaking. The screen displays **Microphone ON**.

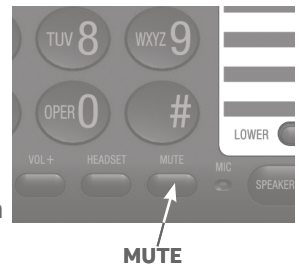

NOTE: Switching between the handset, headset and speakerphone, changing lines, putting a call on hold or starting a conference call cancels the mute function.

Hold

Use this feature to hold one or both lines.

To put a call on hold:

- While on a call, press **HOLD**. The **LINE** indicator for that line flashes slowly to indicate the line is on hold.

If you are using the speakerphone, the speakerphone turns off automatically when you press **HOLD**.

To release hold and return to the call:

- Press the **LINE** button for the call to continue using the preferred mode.

-OR-

Press **HOLD** to return to the call. The **LINE** indicator for the call remains on steadily when you release hold.

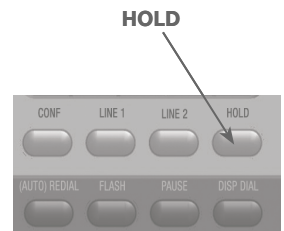

Options while on calls

Temporary tone dialing

If you have dial pulse (rotary) dialing service only, use this feature to temporarily switch from dial pulse to touch-tone dialing during a call.

1. During a call, press **tone** .
2. Use the dialing keys to enter the number you wish to dial. The telephone sends touch-tone signals. The telephone automatically returns to pulse dial mode after you end the call.

Switching between lines

Use this feature to switch between lines during a call.

1. While on a call, press **HOLD** to put the call on hold. Then, press the **LINE** button of the other line to establish a new call or answer an incoming call on that line.
2. To return to the first call, press **HOLD** to put the second call on hold. Then, press the **LINE** button of the original line.

Conference calls

Use this feature to set up a three-party call by using two lines at the same time.

To make a three-way conference call:

1. Make or answer a call.
2. Press **HOLD** to put the call on hold. Press the other **LINE** button to establish a new call or answer an incoming call.
3. Press **CONF** to begin a three-party conference call. The screen displays **Lines 1 and 2 in conference**.

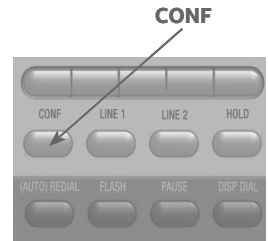

If one caller hangs up during a conference call, a tone will play. Press the **LINE** button of the remaining call to disconnect the other line and stop the tone.

To place a conference call on hold:

1. While on a conference call, press **HOLD** to hold both lines.
2. Press **CONF** to release hold and continue the conference call.

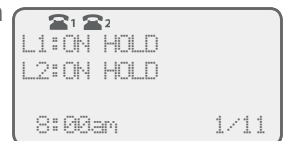

To talk privately with one caller:

1. Press **HOLD** to hold both lines. Press the desired **LINE** button for the caller you want to speak with.
2. When you want to continue the conference call, press **CONF**.

Options while on calls

To drop one line:

- Press the **LINE** button for the caller you want to speak with. The other call is disconnected automatically.

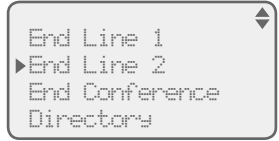

-OR-

1. Press **MENU**.
2. Press **▲** or **▼** to scroll to **End Line 1** or **End Line 2**.
3. Press **ENTER** to end the selected line.

To end a conference call:

- Place the handset on the telephone base to hang up or press **SPEAKER**  or **HEADSET**.

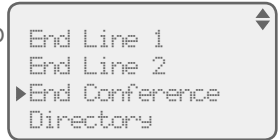

-OR-

1. Press **MENU**.
2. Press **▲** or **▼** to scroll to **End Conference**.
3. Press **ENTER** to end the conference call.

Two-way recording

Use this feature to record two-way telephone conversations during a call. The recording is treated the same as memos and is marked as a new message in the mailbox. The maximum recording time is 12 minutes. The **▶/■/PLAY/STOP** indicator flashes for recordings that have not been reviewed.

To record a call:

1. While on a call, press **MENU**.
2. Press **▲** or **▼** to scroll to **Record**. Press **ENTER**.
3. The recording starts. The timer starts counting while recording. The other party hears a short beep once per minute during the recording.
4. To stop recording and continue the call, press **ENTER**. The system saves the conversation into the mailbox of the line you are using.

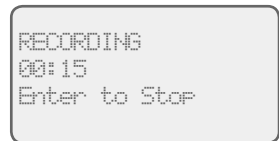
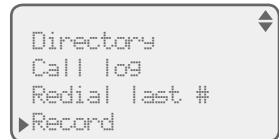

-OR-

The recording ends when you disconnect the call.

To play the recording:

- Play telephone conversation recordings the same as you play messages (see **Message playback** on page 55).



NOTE: To ensure compliance with state and federal regulations regarding the recording of a telephone call, you should inform the other party that you are recording the call before you begin.

Options while on calls

Chain dialing

Use this feature to initiate a dialing sequence from numbers stored in the directory, speed dial memory, call history or redial while you are on a call.

Chain dialing can be useful if you wish to dial other numbers (such as bank account numbers or access codes) during a call.

To access a number (up to 32 digits) from the directory while on a call:

1. Press **DIR**.

-OR-

Press **MENU**, then press ▲ or ▼ to scroll to **Directory**.
Press **ENTER**.



2. Press ▲ or ▼ to scroll or press the dialing keys to find the desired entry (see **Searching by name** on page 37).
3. Press **ENTER** to dial the displayed number.

To access a number (up to 24 digits) from the speed dial memory while on a call:

- Press the speed dial key.

-OR-

Press **LOWER**, then press the speed dial key.
The number is dialed automatically.

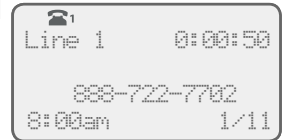

To access a number (up to 24 digits) from the call history while on a call:

1. Press **CID**.

-OR-

Press **MENU**, then press ▲ or ▼ to scroll to **Call log**.
Press **ENTER**.

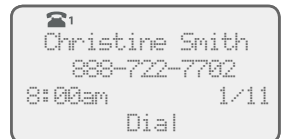

2. Press ◀/**REPEAT** or ▶/**SKIP** to scroll to **Line 1, Line 2** or **Both** to review the call history entries on one or both lines.
Press **ENTER**.
3. Press ▲ or ▼ to scroll to the desired number. Press **ENTER** to dial the displayed number.

To access the last number dialed (up to 32 digits) while on a call:

- Press **(AUTO) REDIAL**. The number is dialed automatically.

-OR-

Press **MENU**. Press ▲ or ▼ to scroll to **Redial last #**. Then, press **ENTER** twice to dial the number.

Speed dial memory overview

This telephone has 18 speed dial locations for storing telephone numbers. You can store up to 24 digits in each location.

The first nine locations can be accessed by using only the speed dial keys. To access the remaining nine locations, press **LOWER** and then the speed dial key for the desired location.

You may wish to write the names or telephone numbers of speed dial entries on the directory card, using the white spaces for the first nine speed dial locations and the gray spaces for the lower nine speed dial locations (see **Directory card** on page 13).

If you need to replace your directory card, see **Directory card** on page 13.

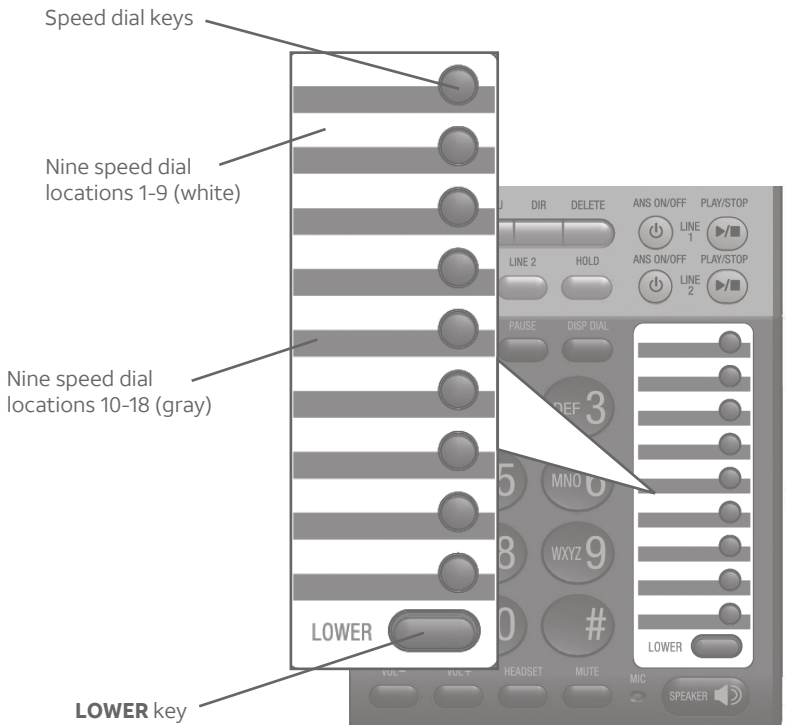

Speed dial operation

Storing a number in a speed dial location

Use the following steps to store a telephone number in the desired speed dial memory location.

1. When the telephone is idle, press **MENU**.
2. Press **▲** or **▼** to scroll to **Speed dial**. Press **ENTER**.
3. Press **▲** or **▼** to scroll to **Program**. Press **ENTER**.
4. Use the dialing keys to enter the telephone number (up to 24 digits).
 - Press **◀/REPEAT** or **▶/SKIP** to move the cursor to the left or right.
 - Press **DELETE** to backspace and delete a digit.
 - Press **PAUSE** to insert a two-second dialing pause. **P** appears on the screen.
5. Press the desired speed dial key.

-OR-

Press **LOWER**, then press the desired speed dial key. The telephone plays a confirmation tone and the screen displays **Stored to speed dial #01** if you store the number in speed dial location 1.

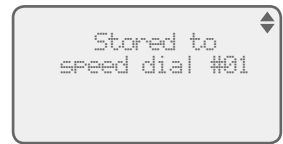
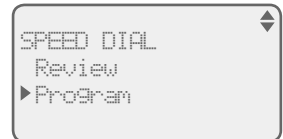
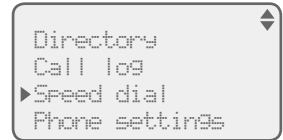

NOTE: If the speed dial memory location you selected is occupied, the new telephone number replaces the old one. Take caution not to replace entries you do not wish to delete.

Reviewing a speed dial number

If **Auto speaker** is turned on (see **Turn auto speaker on or off** on page 18):

1. When the telephone is idle, press **MENU**.
2. Press **▲** or **▼** to scroll to **Speed dial**. Press **ENTER**.
3. Press **▲** or **▼** to scroll to **Review**. Press **ENTER**.
4. Press **▲** or **▼** to scroll through the speed dial numbers.

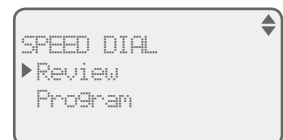

If **Auto speaker** is turned off (see **Turn auto speaker on or off** on page 18):

- When the telephone is idle, press the desired speed dial key.

-OR-

Press **LOWER**, then press the desired speed dial key to review the number.

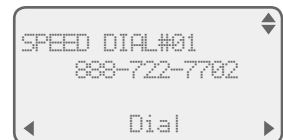

NOTE: If you press the speed dial key when **Auto speaker** is turned on, the number is dialed automatically using the preferred mode (see **Choose the preferred mode** on page 19).

Speed dial operation

Editing a speed dial number

Follow the steps to edit a speed dial number.

1. Follow the steps in **Reviewing a speed dial number** on page 32 to display a speed dial number.
2. Press ◀/REPEAT or ▶/SKIP to scroll to **Edit**.
Press **ENTER**.
3. Use the dialing keys to edit the telephone number.
 - Press ◀/REPEAT or ▶/SKIP to move the cursor to the left or right.
 - Press **DELETE** to backspace and delete a digit.
 - Press **PAUSE** to insert a two-second dialing pause. **P** appears on the screen.
4. Press **ENTER** to save the number. The screen displays **Stored** with a confirmation tone.



Dialing a speed dial number

If **Auto speaker is turned on**, numbers will be dialed using the preferred mode (see **Choose the preferred mode** on page 19). If the preferred mode is **Headset** but no headset is connected, the number will be dialed using the speakerphone.

- Press the desired speed dial key.

-OR-

Press **LOWER**, then press the desired speed dial key.
The number is dialed automatically.



If **Auto speaker** is turned off, or if you want to use the handset or headset regardless of the **Auto speaker** programming:

1. Lift the handset or press **SPEAKER** ◀▶ or **HEADSET**.

-OR-

Press **LINE 1** or **LINE 2** to override automatic line selection.

2. Press the desired speed dial key.

-OR-

Press **LOWER**, then press the desired speed dial key. The number is dialed automatically.

Speed dial operation

To dial the speed dial number while reviewing:

1. Follow the steps in **Reviewing a speed dial number** on page 32 to display a speed dial number.
2. Lift the handset or press **SPEAKER**  or **HEADSET**.



-OR-

To dial the number using your preferred mode (see **Choose the preferred mode** on page 19):

- Press **ENTER** or **DISP DIAL**.
- Press **LINE 1** or **LINE 2** to override automatic line selection.

Deleting a speed dial number

1. Follow the steps in **Reviewing a speed dial number** on page 32 to display a speed dial number.
2. Press **◀/REPEAT** or **▶/SKIP** to scroll to **Clear**.
3. Press **ENTER**. The speed dial number is deleted. The screen displays **Cleared**. Once a number is deleted, it cannot be retrieved.

Directory overview

Directory memory capacity

The directory of this telephone can store up to 100 entries, with a maximum of 16 alphanumeric characters (including spaces) for names and 32 digits for telephone numbers. A convenient search feature can help you quickly find and dial numbers (see **Searching by name** on page 37).

If you try to add a new contact and there are already 100 entries, the screen shows **Directory is full**. You cannot store a new number until you delete one. If you try to review the directory entries when there are none, the screen displays **Directory empty**.

Character chart

Use the dialing keys and the following chart to enter a name (up to 16 characters). Each press of a particular key causes the characters to be displayed in the following order:

Dial Key	Characters by number of key presses								
	1	2	3	4	5	6	7	8	9
1	1	#	'	,	-	.	&		
2	A	B	C	2	a	b	c		
3	D	E	F	3	d	e	f		
4	G	H	I	4	g	h	i		
5	J	K	L	5	j	k	l		
6	M	N	O	6	m	n	o		
7	P	Q	R	S	7	p	q	r	s
8	T	U	V	8	t	u	v		
9	W	X	Y	Z	9	w	x	y	z
0	0								
*	*	?	!	/	()	@		
#	space								



NOTE: When entering a name in the directory, the first letter of each word is automatically capitalized.

Directory operation

Creating a directory entry

Use the following steps to store a name and number in the directory.

1. When the telephone is idle, press **MENU**.
2. Press **▲** or **▼** to scroll to **Directory**. Press **ENTER**.
3. Press **▲** or **▼** to scroll to **Add contact**. Press **ENTER**.
4. To copy one of the last five numbers dialed, press **(AUTO) REDIAL** to enter the redial memory. Press **▲** or **▼** to scroll to the desired number. Press **ENTER**.

-OR-

Use the dialing keys to enter a number (up to 32 digits).

- Press **◀/REPEAT** or **▶/SKIP** to move the cursor to the left or right.
 - Press **DELETE** to backspace and delete a digit.
 - Press **PAUSE** to insert a two-second dialing pause. **P** appears on the screen.
5. Press **ENTER** to move on to enter the name. Use the dialing keys (see **Character chart** on page 35) to enter the name (up to 16 characters).
 - Press **◀/REPEAT** or **▶/SKIP** to move the cursor to the left or right.
 - Press **DELETE** to backspace and delete characters.
 - Press **#** (pound key) to add a space.
 6. Press **ENTER** to save the entry. The screen displays **Saved to Directory**, then returns to the previous menu. To exit without making changes, press **CANCEL**.

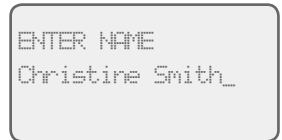
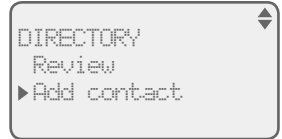
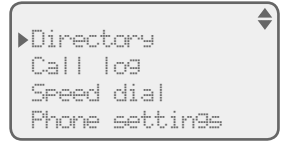

Reviewing directory entries

Use the following steps to review directory entries.

1. When the telephone is idle, press **MENU**.
 - OR-**
 - Press **DIR** to enter the directory and skip to Step 4.
2. Press **▲** or **▼** to scroll to **Directory**. Press **ENTER**.
3. Press **▲** or **▼** to scroll to **Review**. Press **ENTER**.
4. Press **▲** or **▼** to scroll through the directory entries. Press and hold **▲** or **▼** to scroll continuously.

-OR-

Press the dialing keys to search a number by name (see **Searching by name** on page 37).

5. Press and hold **CANCEL** to return to idle mode.

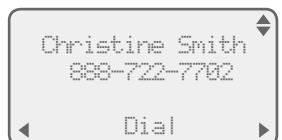
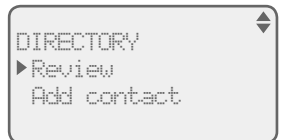
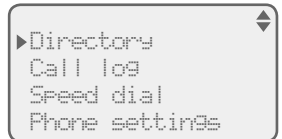

Directory operation

Searching by name

Follow the steps to search for directory entries by name.

1. Follow the steps in **Reviewing directory entries** on page 36 to enter the directory.
2. When in the directory, press the dialing keys to start a name search. The directory shows the first name beginning with the first letter on the dialing key (if there is one).
3. To see other names starting with the letters on the same dialing key, keep pressing the key. The names appear in alphabetical order.

For example, if you have the names **Jennifer**, **Jessie**, **Kevin** and **Linda** in your directory:

If you press **5 (JKL)** once, you see **Jennifer**.

If you press **5 (JKL)** twice, you see **Jessie**.

If you press **5 (JKL)** three times, you see **Kevin**.

If you press **5 (JKL)** four times, you see **Linda**.

If you press **5 (JKL)** five times, you see **Jennifer** again.



NOTE: If there is no name matching the first letter of the key you press, the directory shows a name matching the following letters of that key.

Editing directory entries

Follow the steps to modify the directory entries.

1. Display the desired entry in the directory (see **Reviewing directory entries** on page 36).
2. Press **◀/REPEAT** or **▶/SKIP** to scroll to **Edit**. Press **ENTER**. Press the dialing keys to edit the number.
 - Press **DELETE** to backspace and delete a digit.
 - Press **◀/REPEAT** or **▶/SKIP** to move the cursor to the left or right.
 - Press **PAUSE** to insert a two-second dialing pause. **P** appears on the screen.
3. Press **ENTER** to move on to edit the name. Use the dialing keys to edit.
 - Press **DELETE** to backspace and delete a character.
 - Press **◀/REPEAT** or **▶/SKIP** to move the cursor to the left or right.
 - Press **#** (pound key) to add a space.
4. Press **ENTER** to save the entry. The screen shows the revised entry.

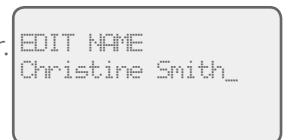
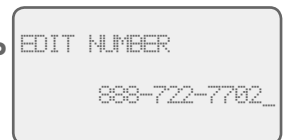
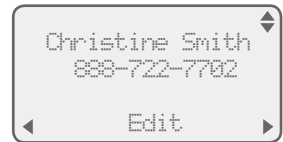

Directory operation

Copying directory entries to speed dial memory

To copy the directory entries (up to 24 digits) into the speed dial memory for easy dialing, follow the steps.

1. Display the desired entry in the directory (see **Reviewing directory entries** on page 36).
2. Press ◀/REPEAT or ▶/SKIP to scroll to **Copy to SpDial**. Press **ENTER**.
3. Press a desired speed dial key.

-OR-

Press **LOWER**, then a desired speed dial key.

The telephone plays a confirmation tone and the screen displays **Stored to speed dial #01** if you store the number in speed dial location 1.

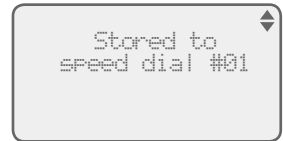
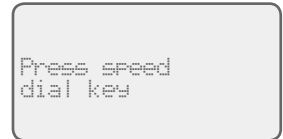
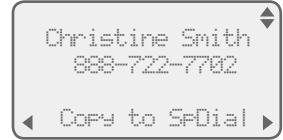

Dialing directory entries

Follow the steps to dial an entry from the directory.

1. Display the desired entry in the directory (see **Reviewing directory entries** on page 36).
2. Lift the handset or press **SPEAKER** or **HEADSET**.

-OR-

To dial the number using your preferred mode (see **Choose the preferred mode** on page 19):

- Press **ENTER** or **DISP DIAL**.
- Press **LINE 1** or **LINE 2** to override automatic line selection.

Deleting directory entries

Follow the steps to delete an entry from the directory.

1. Display the desired entry in the directory (see **Reviewing directory entries** on page 36).
2. Press ◀/REPEAT or ▶/SKIP to scroll to **Delete**. Press **ENTER** to delete the entry.

-OR-

Press **DELETE** to delete the entry.

The screen shows the next directory entry if any. You cannot retrieve an entry once you have deleted it.

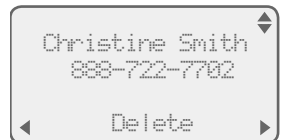

About caller ID

This product supports caller ID services offered by most telephone service providers. Caller ID allows you to see the name, number, date and time of calls. The available caller ID information will appear after the first or second ring.

Information about caller ID with call waiting

Caller ID with call waiting lets you see the name and telephone number of the caller before answering the telephone, and while on another call.

There are fees for caller ID services. In addition, this service might be called different names (such as caller ID with visual call waiting) by different telephone service providers and might not be available in all areas.

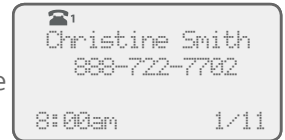

It might be necessary to change your telephone service to use this feature. Contact your telephone service provider if:

- You have both caller ID and call waiting, but as separate services (you might need to combine these services).
- You have only caller ID service, or only call waiting service.
- You don't subscribe to caller ID or call waiting services.

This product can provide information only if both you and the caller are in areas offering caller ID service and if both telephone companies use compatible equipment. The time and date are from the telephone service provider along with the call information.

Caller ID information might not be available for every incoming call. Callers may intentionally block their names and/or telephone numbers.



NOTES:

- You can use this product with regular caller ID service, or you can use this product's other features without subscribing to caller ID or combined caller ID with call waiting service.
- The format of telephone numbers displayed depends on the home and local area codes you set (see **Set home and local area codes** on page 19).

About caller ID

How caller ID history (call log) works

The telephone stores caller ID information for the last 99 incoming calls. Entries are stored in reverse chronological order. The telephone deletes the oldest entry when the log is full to make room for new calls.

If you answer a call before the information appears on the screen, it does not show in the caller ID history.

Review the caller ID history to determine who called, return the call, or copy the caller's name and number into your directory or speed dial memory.

LX: XX Missed appears if there are new call history entries that have not been reviewed on that line (X is the line number and XX is the number of missed calls). **Call log empty** appears if there are no records in the call log.

The time and date of the call and the caller's name and telephone number are included in the display.

Caller ID information appears on the screen as the telephone rings, until the caller hangs up, or the call ends.

If you subscribe to caller ID service, the time and date are automatically reset with the incoming call. You can also set the time and date manually (see **Date and time** on page 16).

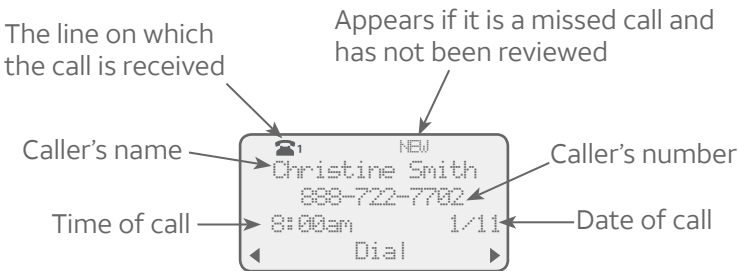

NOTES:

- The caller ID information might not be available for every incoming call. Callers might intentionally block their names and/or telephone numbers (see **Reasons for missing caller ID information** on page 45).
- Each entry can have up to 24 digits for the telephone number and 16 characters for the name. If the telephone number has more than 16 digits but fewer than or equal to 24 digits, only the last 16 digits appear. If the telephone number has more than 24 digits, it is not saved or shown in the call history. If the name has more than 16 characters, only the first 16 characters appear.

Caller ID operation

Memory match

If the incoming telephone number matches the last seven digits of the telephone number in your directory, the name that appears on the screen matches the corresponding name in your directory.



For example, if **Christine Smith** calls, her name appears as **Chris** if this is how you entered it into your directory.



NOTE: The number you see on your caller ID is in the format given by telephone service provider. It usually delivers 10-digit telephone numbers (area code plus telephone number). The telephone system ignores the area code when searching for a match and displays the name of the corresponding number from the directory.

Missed calls indicator

All new or missed call history entries are counted as missed calls. Each time you review a call history entry with **NEW**, the number of missed calls decreases by one. When all the entries in the call log have been reviewed, the missed calls indicator will be removed from the display.

Reviewing call history

- When the telephone is idle, press **MENU**.
-OR-
When the telephone is idle, press **CID** and skip to Step 4.
- Press **▲** or **▼** to scroll to **Call log**. Press **ENTER**.
- Press **▲** or **▼** to scroll to **Review**. Press **ENTER**.
- Press **◀/REPEAT** or **▶/SKIP** to select **Line 1**, **Line 2** or **Both** to review the call history entries on the selected line or both lines. Press **ENTER**.
- Press **▼** to display entries starting with the most recent call. Press **▲** or **▼** to scroll through the call history entries. Press and hold ▲ or ▼ to scroll continuously.
- Press and hold CANCEL to return to idle mode.

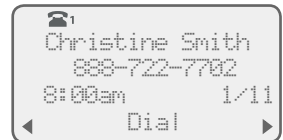
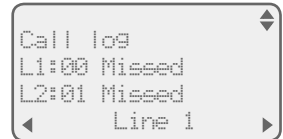
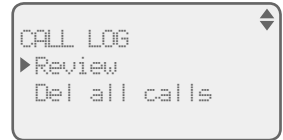
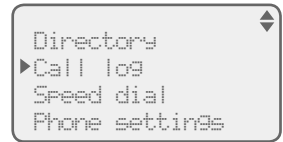

NOTES:

- If there are no call history entries, the screen displays **Call log empty**.
- The telephone plays an error tone when you reach the end of the call history entries.

Caller ID operation

Dialing options

Although the incoming call history entries have 10 digits (the area code plus the seven-digit number), in some areas, you may need to dial only the seven digits, 1 plus the seven digits, or 1 plus the area code plus the seven digits.



While reviewing the call history, press # (pound key) repeatedly to show different dialing options for local and long distance numbers before dialing or saving the telephone number in the directory.

Press # (pound key)

1-888-722-7702

722-7702

1-722-7702

888-722-7702

Dialing a call history entry

1. When in the call history (see **Reviewing call history** on page 41), press ▲ or ▼ to scroll to the number you wish to call. Press # (pound key) repeatedly to select the desired dialing format.
2. Lift the handset or press **SPEAKER** or **HEADSET**.

-OR-

To dial the number using your preferred mode (see **Choose the preferred mode** on page 19):

- Press **ENTER** or **DISP DIAL**.
- Press **LINE 1** or **LINE 2** to override automatic line selection.

Deleting call history entries

Delete a specific call history entry:

1. When in the call history (see **Reviewing call history** on page 41), press ▲ or ▼ to scroll to the number you wish to delete.
2. Press ◀/REPEAT or ▶/SKIP to scroll to **Delete**. Press **ENTER** to delete the entry from the call history.

-OR-

Press **DELETE** to delete the displayed number.

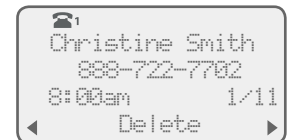

Delete all call history entries:

1. When the telephone is idle, press **MENU**.
2. Press ▲ or ▼ to scroll to **Call log**. Press **ENTER**.
3. Press ▲ or ▼ to scroll to **Del all calls**.
4. Press **ENTER**. The screen displays **Confirm?**.
5. Press **ENTER** to confirm. The screen displays **All deleted**. Then, it automatically returns to the previous menu.

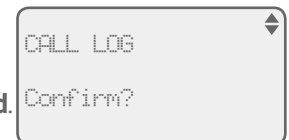
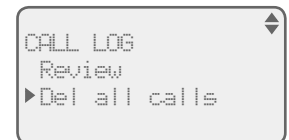

Caller ID operation

Saving a call history entry to the directory

1. When in the call history (see **Reviewing call history** on page 41), press ▲ or ▼ to scroll to the desired entry.

2. Press ◀/REPEAT or ▶/SKIP to scroll to **Copy to DIR**.

-OR-

If you need to add or remove the area code or a 1 at the beginning of the number, do the following:

a. Press # (pound key) repeatedly to scroll through the various dialing formats (area code + seven-digit number, 1 + area code + seven-digit number, seven-digit number or 1 + seven-digit number).

b. Press ◀/REPEAT or ▶/SKIP to scroll to **Copy to DIR**.

3. Press **ENTER**. Use the dialing keys to edit the telephone number (up to 32 digits).

- Press ◀/REPEAT or ▶/SKIP to move the cursor to the left or right.
- Press **DELETE** to backspace and delete a digit.
- Press **PAUSE** to insert a two-second dialing pause. **P** appears on the screen.

4. Press **ENTER** to move on to edit the name. Use the dialing keys (see **Character chart** on page 35) to enter the name (up to 16 characters).

- Press ◀/REPEAT or ▶/SKIP to move the cursor to the left or right.
- Press **DELETE** to backspace and delete a character.
- Press # (pound key) to add a space.

5. Press **ENTER** to save the entry. The telephone plays a confirmation tone and displays the new directory number.

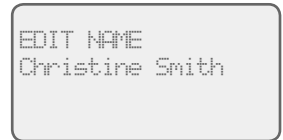
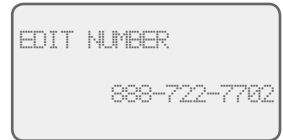
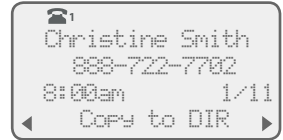

Caller ID operation

Saving a call history entry to a speed dial location

1. When in the call history (see **Reviewing call history** on page 41), press ▲ or ▼ to scroll to the desired entry (up to 24 digits).

2. Press ◀/REPEAT or ▶/SKIP to scroll to **Copy to SpDial**.

-OR-

If you need to add or remove the area code or a 1 at the beginning of the number, do the following:

a. Press # (pound key) repeatedly to scroll through the various dialing formats (area code + seven-digit number, 1 + area code + seven-digit number, seven-digit number or 1 + seven-digit number).

b. Press ◀/REPEAT or ▶/SKIP to scroll to **Copy to SpDial**.

3. Press **ENTER**. The screen displays **Press speed dial key**.

4. Press a desired speed dial key.

-OR-

Press **LOWER**, then press a desired speed dial key to store the entry.

The telephone plays a confirmation tone and the screen displays **Stored to speed dial #01** if you store the number in speed dial location 1.

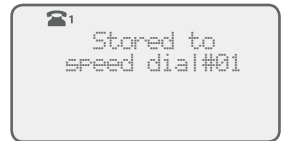
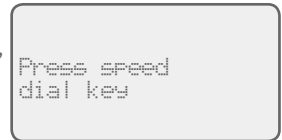
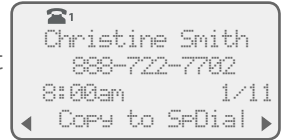

NOTE: If the speed dial location you selected is occupied, the new telephone number replaces the old one. Take caution not to replace entries you do not wish to delete.

Reasons for missing caller ID information

Screen message	Reason
Private name	The caller prefers not to show the name.
Private number	The caller prefers not to show the telephone number.
Private caller	The caller prefers not to show the name and telephone number.
Unknown name	The telephone service provider cannot determine the caller's name.
Unknown number	The telephone service provider cannot determine the caller's telephone number.
Unknown caller	The telephone service provider cannot determine the caller's name and number.

Answering system settings

Voice prompts

The answering system setup for each telephone line is separate. The telephone generates voice prompts to guide you through your answering system setup.

Announcement selection

If you select **Annc A only**, announcement A plays when calls are answered by the answering system. If you select **Annc B only**, announcement B plays when calls are answered by the answering system. If you select **A & B schedule**, you must select the different time intervals for when announcements A and B play. By default, announcement A plays between 8:00am and 4:59pm, and announcement B plays between 5:00pm and 7:59am. The announcement is set to **Annc A only** by default. To change the setting, follow the steps.

1. When the telephone is idle, press **MENU**.
2. Press **▲** or **▼** to scroll to **Answering sys.** Press **ENTER**.
3. Press **▲** or **▼** to scroll to **Mailbox 1** or **Mailbox 2**. Press **ENTER**.
4. Press **▲** or **▼** to scroll to **Announcement**. Press **ENTER**.
5. Press **▲** or **▼** to scroll to **Choose annc.** Press **ENTER**.
6. Press **▲** or **▼** to scroll to **Annc A only**, **Annc B only** or **A & B schedule**.
7. Press **ENTER** to save the setting. The telephone plays a confirmation tone and returns to the previous menu.

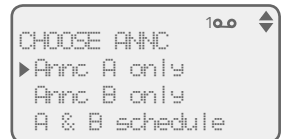
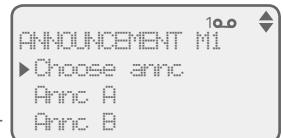
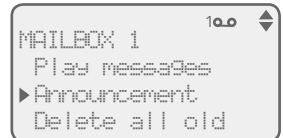

Answering system settings

Announcement A and B

The default greeting for announcements A and B is “*Hello, please leave a message after the tone.*” The telephone is preset to answer with the default announcement A. You can use this default announcement or replace it with your own.

To play the current announcement A or B:

1. Follow Steps 1-4 in **Announcement selection** on page 46.
2. Press **▲** or **▼** to scroll to **Annc A** or **Annc B**. Press **ENTER**.
3. Press **▲** or **▼** to scroll to **Play**. Press **ENTER** to play the announcement.

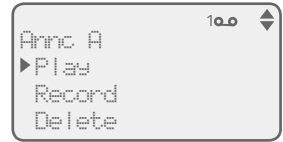
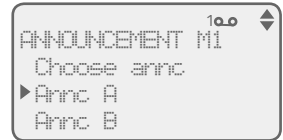

To record a new announcement A or B:

1. Follow Steps 1-4 in **Announcement selection** on page 46.
2. Press **▲** or **▼** to scroll to **Annc A** or **Annc B**. Press **ENTER**.
3. Press **▲** or **▼** to scroll to **Record**.
4. Press **ENTER**. The telephone announces, “*Record after the tone. Press STOP when you are done.*” After the tone, speak towards the microphone of the telephone base to record an announcement of up to 90 seconds. Announcements shorter than two seconds cannot be recorded. If the memory is full, the system announces, “*Memory is full.*” You must delete some messages before recording.
5. Press **▶/■/PLAY/STOP** of the corresponding line when finished. The answering system automatically plays back the newly recorded announcement.



To delete announcement A or B:

1. When the telephone is idle, press **MENU**.
2. Press **▲** or **▼** to scroll to **Answering sys.** Press **ENTER**.
3. Press **▲** or **▼** to scroll to **Mailbox 1** or **Mailbox 2** to select the desired line. Press **ENTER**.
4. Press **▲** or **▼** to scroll to **Announcement**. Press **ENTER**.
5. Press **▲** or **▼** to scroll to **Annc A** or **Annc B**. Press **ENTER**.
6. Press **▲** or **▼** to scroll to **Delete**. Press **ENTER**. The telephone plays a confirmation tone and returns to the previous menu.

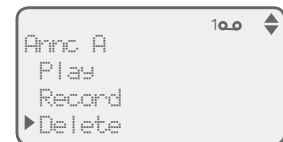

When your announcement is deleted, calls are answered with the default announcement.

Answering system settings

Announcement A and B time settings

These settings allow you to set different time intervals for when to play your two different announcements (see **Announcement selection** on page 46). The default start times for announcements A and B are 8:00am and 5:00pm, respectively. To change these settings:

1. When the telephone is idle, press **MENU**.
2. Press **▲** or **▼** to scroll to **Answering sys.**
Press **ENTER**.
3. Press **▲** or **▼** to scroll to **Mailbox 1** or **Mailbox 2**.
Press **ENTER**.
4. Press **▲** or **▼** to scroll to **Announcement**.
Press **ENTER**.
5. Press **▲** or **▼** to scroll to **Set annc A time** or **Set annc B time**. Press **ENTER**.
6. Use the dialing keys to enter the time. To enter a number that is less than 10, you have to enter a 0 before the digit. Press **◀/REPEAT** or **▶/SKIP** to move the cursor to the left or right.

-OR-

Press **▲** or **▼** to scroll to the desired digit. Press **ENTER** to move on to set the next digit. Press **◀/REPEAT** or **▶/SKIP** to move the cursor to the left or right.

7. Press **▲** or **▼** to select **AM** or **PM**.
8. Press **ENTER** to save your selection. The telephone plays a confirmation tone and returns to the previous menu.

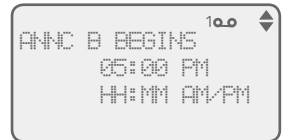
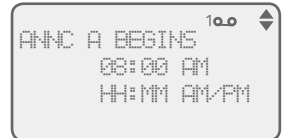
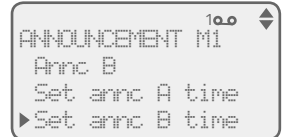

Answering system settings

Answer on/off

By default, the answering system is on and ready to record messages on each telephone line. When the answering system of the corresponding line is on, the corresponding **📞/ANS ON/OFF** indicator light is on. If you turn the answering system off, the answering system does not answer calls and record incoming messages.

- Press **📞/ANS ON/OFF LINE 1** or **📞/ANS ON/OFF LINE 2** to turn the corresponding answering system on or off. When the answering system is turned on, it announces, “Calls will be answered.” The **📞/ANS ON/OFF LINE 1** or **📞/ANS ON/OFF LINE 2** indicator light turns on. When the answering system is turned off, it announces, “Calls will not be answered.” The **📞/ANS ON/OFF LINE 1** or **📞/ANS ON/OFF LINE 2** indicator light turns off.

You can also turn the telephone answering system on or off in the menu by following the steps:

1. When the telephone is idle, press **MENU**.
2. Press **▲** or **▼** to scroll to **Answering sys.** Press **ENTER**.
3. Press **▲** or **▼** to scroll to **Mailbox 1** or **Mailbox 2**. Press **ENTER**.
4. Press **▲** or **▼** to scroll to **Answer ON/OFF**. Press **ENTER**.
5. Press **▲** or **▼** to scroll to **On** or **Off**.
6. Press **ENTER** to save the setting. The telephone plays a confirmation tone and returns to the previous menu.

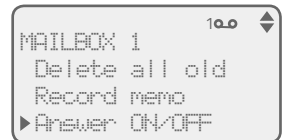
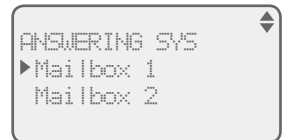
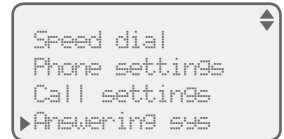

NOTES:

- If the recording memory is full, the telephone announces, “Calls will not be answered. Memory is full,” when you press **📞/ANS ON/OFF LINE 1** or **📞/ANS ON/OFF LINE 2** and the answering system cannot be turned on.
- If the answering system is off and you press **ENTER** to save the settings in the **Ans sys setup** and **Choose Annc** menus, the answering system will be automatically turned on.

Answering system settings

Call screening

Use this feature to set whether incoming messages are played through the speaker while they are being recorded. **Call screening** is **On** by default.

1. When the telephone is idle, press **MENU**.
2. Press **▲** or **▼** to scroll to **Answering sys.** Press **ENTER**.
3. Press **▲** or **▼** to scroll to **Mailbox 1** or **Mailbox 2** to select the desired line. Press **ENTER**.
4. Press **▲** or **▼** to scroll to **Ans sys setup.** Press **ENTER**.
5. Press **▲** or **▼** to scroll to **Call screening.** Press **ENTER**.
6. Press **▲** or **▼** to select **On** or **Off**.
7. Press **ENTER** to save your selection. The telephone plays a confirmation tone and returns to the previous menu.

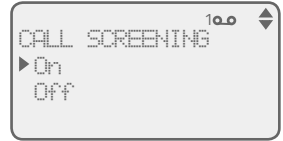
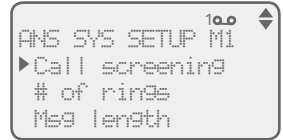

Number of rings

Use this feature to set how many times the telephone rings before the answering system picks up the call. You can select two, four, six or toll saver, which is explained below. The number of rings is four by default.

1. When the telephone is idle, press **MENU**.
2. Press **▲** or **▼** to scroll to **Answering sys.** Press **ENTER**.
3. Press **▲** or **▼** to scroll to **Mailbox 1** or **Mailbox 2** to select the desired line. Press **ENTER**.
4. Press **▲** or **▼** to scroll to **Ans sys setup.** Press **ENTER**.
5. Press **▲** or **▼** to scroll to **# of rings.** Press **ENTER**.
6. Press **▲** or **▼** to select **2**, **4**, **6** or **Toll saver**.
 - Toll saver - the answering system answers a call after two rings if you have new messages, and after four rings when there are no new messages. This feature allows you to check for new messages and avoid paying long distance charges when calling from out of your local area.
7. Press **ENTER** to save your selection. The telephone plays a confirmation tone and returns to the previous menu.

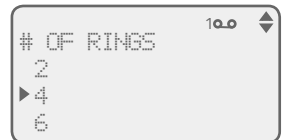
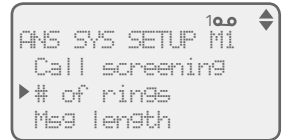

Answering system settings

Incoming message length

Use this feature to set the recording time allowed for incoming messages. The message length is one minute by default.

1. When the telephone is idle, press **MENU**.
2. Press **▲** or **▼** to scroll to **Answering sys.** Press **ENTER**.
3. Press **▲** or **▼** to scroll to **Mailbox 1** or **Mailbox 2** to select the desired line. Press **ENTER**.
4. Press **▲** or **▼** to scroll to **Ans sys setup.** Press **ENTER**.
5. Press **▲** or **▼** to scroll to **Msg length.** Press **ENTER**.
6. Press **▲** or **▼** to select **1 min**, **2 min** or **4 min**.
7. Press **ENTER** to save your selection. The telephone plays a confirmation tone and returns to the previous menu.

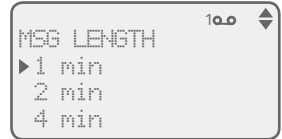

Remote code

If you want to remotely access your mailbox from any touch-tone telephone, set the remote code to **On** and enter a three-digit (**000-999**) remote code. If you do not use this feature, set the remote code to **Off**. The default remote access code is **500**. To change the settings:

1. When the telephone is idle, press **MENU**.
2. Press **▲** or **▼** to scroll to **Answering sys.** Press **ENTER**.
3. Press **▲** or **▼** to scroll to **Mailbox 1** or **Mailbox 2** to select a desired mailbox. Press **ENTER**.
4. Press **▲** or **▼** to scroll to **Ans sys setup.** Press **ENTER**.
5. Press **▲** or **▼** to scroll to **Remote code.** Press **ENTER**.
6. Press **▲** or **▼** to select **On** or **Off**.

If you select **On**:

- a. Press **ENTER**.
- b. Press the dialing keys (**0-9**) to enter a three-digit code. Press **◀/REPEAT** or **▶/SKIP** to move the cursor to the left or right. Press **DELETE** to backspace and erase a digit.
- c. Press **ENTER** to save the digits.

-OR-

If you select **Off**, press **ENTER** to save the setting.

The telephone plays a confirmation tone and returns to the previous menu.

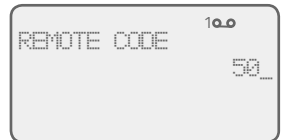
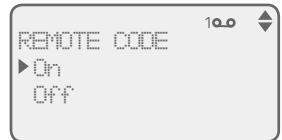
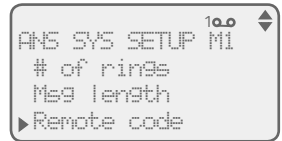

NOTE: The remote code must be different from the priority code.

Answering system settings

Priority code

Priority calling allows a caller to enter a code during the outgoing announcement that plays a special tone so that you know who is calling. To enable a priority call, set the priority code to **On** and enter a three-digit priority code (**000-999**). If you do not use this feature, set the priority code to **Off**. The default priority code is **999**. To change the settings:

1. When the telephone is idle, press **MENU**.
2. Press **▲** or **▼** to scroll to **Answering sys.** Press **ENTER**.
3. Press **▲** or **▼** to scroll to **Mailbox 1** or **Mailbox 2** to select the desired line. Press **ENTER**.
4. Press **▲** or **▼** to scroll to **Ans sys setup.** Press **ENTER**.
5. Press **▲** or **▼** to scroll to **Priority code.** Press **ENTER**.
6. Press **▲** or **▼** to select **On** or **Off**.

If you select **On**, do the following:

- a. Press **ENTER**.
- b. Press the dialing keys (**0-9**) to enter a three-digit code. Press **◀/REPEAT** or **▶/SKIP** to move the cursor to the left or right. Press **DELETE** to backspace and erase a digit.
- c. Press **ENTER** to save the digits.

-OR-

If you select **Off**, press **ENTER** to save your selection.

The telephone plays a confirmation tone and returns to the previous menu.

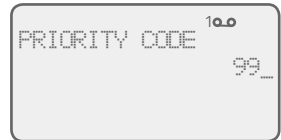
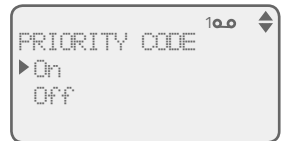
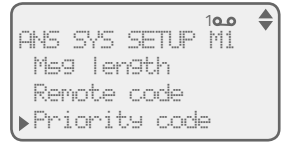

Message alert tone

If you turn this feature on, the telephone beeps every 10 seconds when there are new messages. The tone stops when all new messages have been played.

1. When the telephone is idle, press **MENU**.
2. Press **▲** or **▼** to scroll to **Answering sys.** Press **ENTER**.
3. Press **▲** or **▼** to scroll to **Mailbox 1** or **Mailbox 2** to select a desired mailbox. Press **ENTER**.
4. Press **▲** or **▼** to scroll to **Ans sys setup.** Press **ENTER**.
5. Press **▲** or **▼** to scroll to **Msg alert tone.** Press **ENTER**.
6. Press **▲** or **▼** to select **On** or **Off**.
7. Press **ENTER** to save your selection. The telephone plays a confirmation tone and returns to the previous menu.

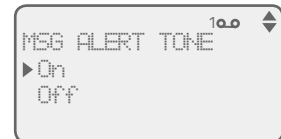
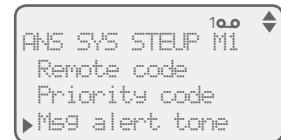

NOTE: The answering system must be turned on for the message alert tone to function.

Answering system and voicemail

Your telephone has separate indicators for two different types of voice messages: those left on its built-in answering system and those left at your service provider's voicemail (fees may apply). Your telephone's built-in answering system messages and voicemail messages are separate. Each alerts you to new messages differently.

If **Voicemail** appears and **L1** and/or **L2** flashes on the display, your telephone service provider is indicating that it has new voicemail for you on line 1 and/or line 2. To listen to your voicemail, dial an access number provided by your telephone service provider, followed by a security code or PIN.

To listen to messages recorded on your digital answering system, press **▶/■/PLAY/STOP LINE 1** or **▶/■/PLAY/STOP LINE 2** on the telephone base (see page 55).

Some service providers bundle or combine multiple services like voicemail and call waiting, so you may not be aware that you have voicemail. To check what services you have and how to access them, contact your telephone service provider.

To use your voicemail service rather than the answering system, turn off the answering system. To use the answering system rather than your voicemail service, contact your telephone service provider to deactivate your voicemail service. You can also use your telephone answering system and voicemail together by setting your built-in answering system to answer before voicemail answers, as described below.

Set your answering system to answer calls at least two rings earlier than your voicemail is set to answer. For example, if your voicemail answers after six rings, set your answering system to answer after four rings. If you are on a call, or if the answering system is busy recording a message and you receive another call, the second caller can leave a voicemail message. Some voicemail providers may program the delay before answering calls in seconds instead of rings. In this case, allow six seconds per ring when determining the appropriate setting.

To learn how to program your voicemail settings, contact your telephone service provider.

Answering system operation

Message capacity

The answering system of each line can record and store up to 99 messages. The recording time of each message depends on the message length you set (see **Incoming message length** on page 51). The total storage capacity of each line for the announcement, messages, memos or two-way recording is approximately 12 minutes. The actual recording time depends on individual message characteristics. Messages remain available for replay until you delete them.

Answering system new message indication

The ►/■/PLAY/STOP indicator flashes and **o** shows on the screen when there are new messages, memos or conversation recordings in the mailboxes.

When the new message alert tone is turned on (see **Message alert tone** on page 52), the telephone beeps every 10 seconds when there are unheard messages. Press any key to temporarily silence the message alert tone. The next incoming message beeps normally.

Call screening

If the answering system and call screening are on (see **Call screening** on page 50), you hear the announcement and the incoming message when receiving a call. While recording messages, press **VOL-** or **VOL+** to adjust the volume, press ►/■/PLAY/STOP of the corresponding line to temporarily silence the call screening, or press ►/■/PLAY/STOP of the corresponding line to continue listening the call screening.

Call intercept

When a caller is leaving a message on your answering system, you can stop recording and speak to the caller by pressing the **LINE** button for the call.

Priority code

You may want to give your priority code (see **Priority code** on page 52) to a caller so that you know who is calling. The caller should enter your priority code while the answering system is playing the announcement. The telephone then plays the priority call tone to alert you that a caller with high priority is calling.

Answering system operation

Message playback

If you have new messages on either line, the ►/■/PLAY/STOP indicator for that line flashes. The ►/■/PLAY/STOP indicator turns off after you listen to the new messages.

When playback begins, the total number of messages is announced. Before each message, you hear the date and time of the recording. If the date and time are not set, the answering system announces, “*Time and day not set,*” before each message (see **Date and time** on page 16). The telephone plays only the new messages (in chronological order). If there are no new messages, the system plays all the messages (in chronological order).

After the last message, you hear “*End of messages.*” If the system has less than three minutes of recording time left, you hear, “*Less than three minutes to record.*” When the answering system has no recording time left, it announces, “*Memory is full.*”

To listen to messages:

1. Press ►/■/PLAY/STOP LINE 1/LINE 2 to listen to the messages. The system announces the number of messages, then begins the playback.
2. Press ►/■/PLAY/STOP LINE 1/LINE 2 to end the message playback.

You can also play the messages in the menu by following the steps mentioned below:

1. When the telephone is idle, press **MENU**.
2. Press ▲ or ▼ to scroll to **Answering sys.** Press **ENTER**.
3. Press ▲ or ▼ to scroll to **Mailbox 1** or **Mailbox 2**. Press **ENTER**.
4. Press ▲ or ▼ to scroll to **Play messages**. Press **ENTER**, then the system announces the number of old messages and new messages.
5. Press ▲ or ▼ to scroll to **Play old msgs** or **Play new msgs**. Press **ENTER** to play the messages.

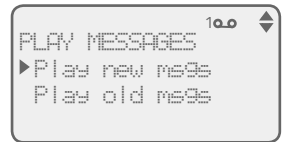
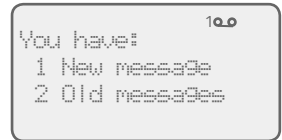
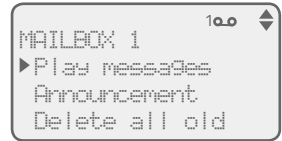

Options during playback

When a message is playing, you can adjust the playback volume, skip, repeat, or delete the message.

When a message is playing:

- Press **VOL-** or **VOL+** to adjust the speaker volume.
- Press ►/SKIP to skip to the next message.
- Press ◀/REPEAT to repeat the message currently playing. Press ◀/REPEAT twice to listen to the previous message.
- Press **DELETE** to delete the current message. The system announces, “*Message deleted,*” and advances to the next message.
- Press ►/■/PLAY/STOP to end the message playback.

Answering system operation

Delete all old messages

Use this feature to delete old (reviewed) messages. You cannot delete new messages until you review them. You cannot retrieve deleted messages.

1. When the telephone is idle, press **MENU**.
2. Press **▲** or **▼** to scroll to **Answering sys.** Press **ENTER**.
3. Press **▲** or **▼** to scroll to **Mailbox 1** or **Mailbox 2**. Press **ENTER**.
4. Press **▲** or **▼** to scroll to **Delete all old**.
5. Press **ENTER**. The screen displays **Delete all old messages?**
6. Press **ENTER** to delete all old messages. The telephone plays a confirmation tone and the screen displays **All old messages deleted!**

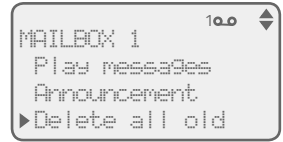

-OR-

1. When the telephone is idle, press **DELETE**.
2. Press **▲** or **▼** to scroll to **Mailbox 1** or **Mailbox 2**.
3. Press **ENTER**. The screen displays **Delete all old messages?**
4. Press **ENTER** to delete all old messages. The telephone plays a confirmation tone and the screen displays **All old messages deleted!**



NOTE: If there are no messages in the mailbox you accessed, the screen displays **No message**.

Record and play memos

Memos are messages you can record for yourself or the people in your household. Memos are saved, played, and deleted exactly like incoming messages. Each memo can be up to four minutes. Memos shorter than one second are not recorded. If there is no recording time left, the system announces, *"Memory is full."*

To record a memo:

1. When the telephone is idle, press **MENU**.
2. Press **▲** or **▼** to scroll to **Answering sys.** Press **ENTER**.
3. Press **▲** or **▼** to scroll to **Mailbox 1** or **Mailbox 2**. Press **ENTER**.
4. Press **▲** or **▼** to scroll to **Record memo**. Press **ENTER**. The system announces, *"Record after the tone. Press STOP when you are done."* After the tone, speak towards the microphone.
5. Press **▶/■/PLAY/STOP** when finished recording. The system announces, *"Recorded,"* and then returns to the previous menu.

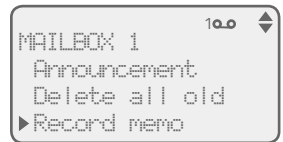

Remote access

A three-digit security code is required to access the answering system remotely from any touch-tone telephone. The default code is **500**. See **Remote code** on page 51 to change it.

To remotely access the answering system:

1. Dial your telephone number from any touch-tone telephone.
2. When the system plays your announcement, enter the three-digit remote access code.
3. Once you are in remote access mode, enter one of the following commands. If you do not press any keys after you enter the remote access code, all new messages play. If there are no new messages, all old messages play.

Command	Function
1	Play all messages.
2	Play only new messages.
3	Delete the current message (during playback).
33	Delete all messages.
4	Repeat the current message (during playback).
44	Listen to the previous message (during playback).
5	Stop.
*5	Hear a list of remote commands.
6	Skip to the next message (during playback).
*7	Record new announcement A.
*8	Record new announcement B.
*9	End the call.
0	Turn the answering system on or off.

4. Hang up or press ***9** to end the call.

Cut out the remote access wallet card at the back of this user's manual for quick reference.



NOTES:

- Once the new messages have played, the telephone announces the help menu options. If you do not press a key within 20 seconds, the remote access call automatically disconnects.
- When the answering system is turned off, the telephone answers after 10 rings and announces, "Please enter your remote access code."
- When the memory is full, the answering system answers incoming calls after 10 rings and announces, "Memory is full. Enter the remote access code."

Screen icons, indicator lights and alert tones

Indicator lights

Lighted display →

LINE 1/LINE 2 indicator
 On when the telephone line is in use.
 Flashes slowly when the call is on hold.
 Flashes rapidly when there is an incoming call.

(AUTO) REDIAL →
 On when auto redial is activated.

ANS ON/OFF indicator
 On when the answering system is on and ready to receive calls.

PLAY/STOP indicator
 Flashes when there are new messages in the mailbox.

HEADSET indicator
 On when the headset is in use.

MUTE indicator
 On when the corded handset microphone, speakerphone or headset is muted.

SPEAKER indicator
 On when the speakerphone is on.

Screen icons

	Line 1 is in use.
	Line 2 is in use.
	The ringer on line 1 is muted.
	The ringer on line 2 is muted.
	The ringers on both line 1 and line 2 are muted.
	There are new messages in mailbox 1 or mailbox 1 is in use.
	There are new messages in mailbox 2 or mailbox 2 is in use.
	There are new messages in mailboxes 1 and 2, or mailboxes 1 and 2 are in use.
	The missed call is new and has not been reviewed.
	<ul style="list-style-type: none"> On steadily when no backup batteries have been installed while the power adapter is connected. Flashes when backup battery power is low during a power failure.

Screen icons, indicator lights and alert tones

Alert tones

One short beep	<ul style="list-style-type: none"> • There are new messages that have not been reviewed when the message alert tone is turned on. • While your telephone conversation is being recorded, you will hear one beep per minute. • You receive a call while you are already on a call.
Confirmation tone (one short beep)	<ul style="list-style-type: none"> • The command has been completed successfully.
Error tone (two short beeps)	<ul style="list-style-type: none"> • You press VOL+ or VOL- after the volume has already reached its highest or lowest setting. • You have reached the end of the call history entries. • You have pressed (AUTO) REDIAL when the redial list is empty. • No headset is plugged into the telephone base when you press HEADSET. • The requested task cannot be completed due to missing information or an input error.

Screen display messages

All deleted	All call history entries have been removed.
All old messages deleted!	All old messages in the selected mailbox have been deleted.
Already saved	The number you entered in the directory has already been saved.
Call answered	The call is answered by the answering system.
Call log empty	There are no entries in the call history.
Cleared	A speed dial entry has been deleted.
Conf.	You have created a three-way conference call.
Directory empty	There are no entries in the directory.
Directory is full	The directory memory is full.
Empty	There are no numbers in the speed dial location you pressed.
Ended	A call has just ended.
Line X Incoming call	There is an incoming call on line X.
LOWER SPEED DIAL	You have accessed the lower speed dial memory.
LX: Ans Sys Full	The answering system memory of line X is full. Messages cannot be recorded.
LX:IN USE	The telephone on the same line with line X is in use.
LX:NO LINE	There is no telephone line cord connected to line X.
LX:ON HOLD	Line X is put on hold.
LX:XX New Msgs	There are XX new messages on line X.
LX:XX Missed	XX calls on line X have not been reviewed.
Memory Full	The memory is full. You cannot record any messages.
Message deleted	The message currently playing is deleted.
Microphone off	Mute is on.
Microphone ON	Mute is off.
NO AC POWER	Power fails and no backup batteries are installed.
No message	There are no messages in the mailbox you selected.
Only 24 digits are allowed	The call history entry, redial number or the directory entry you saved in the speed dial location is over 24 digits.

Screen display messages

Recording message	The answering system is recording a message.
Ringer muted	The ringer is muted.
Saved to Directory	The entry has been saved successfully into the directory.
VM indicator cleared	The voicemail indicator has been deleted.
Voicemail:LX	There is a new voicemail message on line X.

Troubleshooting

If you have difficulty with your telephone, please try the following suggestions. For customer service, visit our website at www.telephones.att.com or call **1 (800) 222-3111**. In Canada, dial **1 (866) 288-4268**.

My telephone does not work at all.

- Make sure the power adapter is securely plugged into an electrical outlet not controlled by a wall switch.
- Make sure you plug the telephone line cord securely and firmly into the telephone jack and the telephone wall jack.
- Unplug the power adapter from the electrical outlet. Wait for approximately 15 seconds, then plug it back in. Allow up to one minute for the telephone to reset.
- You may need to purchase three AA alkaline batteries as backup batteries to make the telephone work in the event of a power failure. Please refer to **Optional backup battery installation** on page 4 in this user's manual.
- Disconnect the telephone base from the telephone wall jack and plug in a working telephone. If that telephone does not work, the problem is probably in the wiring or the telephone service. Call your telephone service provider.

The display shows LX:NO LINE. I cannot get a dial tone.

- Try all the suggestions, as mentioned above.
- Make sure you plug the handset cord securely and firmly into the handset jack on the telephone base and the corded handset.
- Make sure **HOLD** is not pressed.
- If there is no dial tone when the **HEADSET** key is pressed, make sure a corded headset is firmly connected in the headset jack.
- If you are only using one telephone line, make sure to set it as the primary line (see **Set the primary line** on page 18).
- If the previous suggestions do not work, disconnect the telephone line cord from your telephone and connect the telephone line cord to another telephone.
 - If there is no dial tone on that other telephone either, your telephone line cord may be defective. Install a new telephone line cord.
 - If changing the telephone line cord does not help, the wall jack (or the wiring to this wall jack) may be defective. Try using a different wall jack in your home to connect your ML17939 telephone, or contact your telephone service provider (charges may apply).

I cannot dial out.

- Try all the suggestions, as mentioned above.
- Make sure there is a dial tone before dialing. The telephone might take a second or two to produce a dial tone. This is normal. Wait an extra second before dialing.

Troubleshooting

- Check that all the telephones connected to the same telephone line are hung up.
- Eliminate any background noise. Noise from a television, radio or other appliances might cause the telephone to not dial out properly. If you cannot eliminate the background noise, first try muting the corded handset before dialing, or dialing from another room with less background noise.
- If other telephones in your building are having the same problem, contact your telephone service provider (charges might apply).

I hear other calls while using my telephone.

- Disconnect the telephone base from the telephone jack, and plug in a different telephone. If you still hear other calls, call your telephone service provider.

My telephone does not ring when I receive a call.

- Make sure that the ringer is not turned off (see **Ringer volume** on page 15).
- Make sure you plug in the telephone line cord securely into the telephone base and the telephone jack. Make sure you plug in the power cord securely.
- There might be too many extension telephones on the telephone line to allow all of them to ring simultaneously. Try unplugging one telephone at a time until the telephones start ringing.
- If other telephones in your building are having the same problem, contact your telephone service provider (charges might apply).
- Test a working telephone at the telephone jack. If another telephone has the same problem, contact your telephone service provider (charges might apply).
- Your telephone line cord might be malfunctioning. Try installing a new telephone line cord.

My calls cut in and out while I'm using my corded handset.

- If you are using the handset when this problem occurs, try unplugging the coiled handset cord and firmly plugging it in the handset and telephone base again.
- If you are using the headset, try unplugging it and firmly plugging it in again.
- If you are using the speakerphone, eliminate any background noise. Noise from a television, radio, or other appliances might cause the speakerphone to cut in and out. To eliminate the background noise, try pressing **MUTE** when you are not speaking.
- Disconnect the telephone base from the telephone wall jack and plug in another corded telephone. If calls are still not clear, the problem is probably in the wiring or telephone service. Contact your telephone service provider (charges may apply).

Troubleshooting

- If you subscribe to high-speed Internet service (DSL - digital subscriber line) through your telephone line(s), you must install a DSL filter between each telephone line cord and telephone wall jack (see **Telephone base installation** on pages 6-7). The filter prevents noise and caller ID problems caused by DSL interference. Please contact your DSL service provider for more information about DSL filters.

My caller ID isn't working.

- Caller ID is a subscription service. You must subscribe to this service from your telephone service provider for this feature to work on your telephone base.
- The caller must be calling from an area that supports caller ID.
- Both your and your caller's telephone service provider must use caller ID compatible equipment.
- If you subscribe to high-speed Internet service (DSL - digital subscriber line) through your telephone line(s), you must install a DSL filter between each telephone line cord and telephone wall jack (see **Telephone base installation** on pages 6-7). The filter prevents noise and caller ID problems resulting from DSL interference. Please contact your DSL service provider for more information about DSL filters.

System does not receive caller ID when on a call.

- Make sure you subscribe to caller ID with call waiting features from your telephone service provider. Caller ID feature works only if both you and the caller are in areas offering caller ID service, and if both telephone companies use compatible equipment.

The answering system records incomplete messages.

- The recording time of each message depends on the message length you set (see **Incoming message length** on page 51).
- If a caller leaves a very long message, part of it may be lost when the system disconnects the call after the preset message recording time.
- If the caller pauses for longer than seven seconds, the system stops recording and disconnects the call.
- If the system's memory becomes full during a message, the system stops recording and disconnects the call.
- If the caller's voice is very soft, the system may stop recording and disconnect the call.

System does not answer after the correct number of rings.

- Make sure that the answering system is on (see **Answer on/off** on page 49).
- If toll saver is activated, the number of rings changes to two when you have new messages stored (see **Number of rings** on page 50).
- If the memory is full or the system is off, the system will answer after 10 rings.

Troubleshooting

System does not respond to remote commands.

- Make sure the remote code is on and you have entered a three-digit remote code (see **Remote code** on page 51).
- Make sure you are calling from a touch-tone telephone. When you dial a number, you should hear tones. If you hear clicks, the telephone is not a touch-tone telephone and cannot activate the answering system.
- The answering system may not detect the remote access code while your announcement is playing. Try waiting until the announcement is over before entering the code.
- There may be interference on the telephone line you are using. Press the dialing keys firmly.

System does not record messages.

- Make sure the answering system is on (see **Answer on/off** on page 49).
- Make sure the memory of the answering system is not full.
- If you have voicemail service in addition to your answering system, your callers' messages may be going into voicemail before your answering system picks up the call. Program your voicemail to pick up at least two rings after the number of rings your answering system is set to answer the call (see **Answering system and voicemail** on page 53).

The outgoing announcement is not clear.

- When you record your announcement, make sure you speak in a normal tone of voice, about nine inches from the telephone base.
- Make sure there is no background noise (TV, music, etc.) while recording.

The outgoing announcement used is different from the one I recorded.

- There are a total of four possible announcements that can be used (Annc A and Annc B for each mailbox). Make sure to record the correct announcements for each mailbox (see **To record a new announcement A or B** on page 47). Also be sure to set the correct announcement(s) to be played (see **Announcement selection** on page 46) and times they are played (see **Announcement A and B time settings** on page 48).

Voicemail appears and L1 and/or L2 flashes on the display.

- Your telephone has voicemail indication that is separate from the built-in answering system. If **Voicemail** appears and **L1** and/or **L2** flashes on the display, then your telephone has received a signal from your telephone service provider that you have a voicemail message on line 1 and/or line 2 waiting for you to retrieve from your telephone service provider. Contact your telephone service provider for more information on how to access your voicemail.

Troubleshooting

I cannot retrieve voicemail messages.

- Your telephone has both a built-in answering system and voicemail indication. They are independent features and each alerts you to new messages differently (see **Answering system and voicemail** on page 53). If you subscribe to voicemail service from your telephone service provider (charges may apply), contact your telephone service provider for more information on how to access your voicemail.

I subscribe to a nontraditional telephone service that uses my computer to establish connections, and my telephone doesn't work.

- Make sure your computer is powered on.
- Make sure your Internet connection is working properly.
- Make sure that the software is installed and running for your nontraditional telephone service.
- Make sure to plug your USB telephone adapter into a dedicated USB port on your computer. Do not plug into a multiple port USB hub (USB splitter) that is not powered.
- In a few rare instances, the USB port on your computer may not have enough power. In these instances, try using a USB hub with its own external power supply.
- If you are using a firewall, it may prevent access to your nontraditional telephone service. Contact your service provider for more information.

Common cure for electronic equipment.

If the telephone base does not seem to be responding normally, do the following (in the order listed):

- Disconnect the power to the telephone base.
- Remove the spare batteries, if applicable.
- Wait a few minutes.
- Connect power to the telephone base.
- Install the backup batteries.

General product care

To keep your telephone working well and looking good, follow these guidelines:

- Avoid putting it near heating appliances and devices that generate electrical noise (for example, motors or fluorescent lamps).
- DO NOT expose it to direct sunlight or moisture.
- Avoid dropping the telephone or treating it roughly.
- Clean with a soft cloth.
- Never use a strong cleaning agent or abrasive powder because this can damage the finish.
- Retain the original packaging in case you need to ship it at a later date.

Important safety information



This symbol is to alert you to important operating or servicing instructions that may appear in this user's manual. Always follow basic safety precautions when using this product to reduce the risk of injury, fire, or electric shock.

Safety information

- **Read and understand all instructions in the user's manual. Observe all markings on the product.**
- **Avoid using a telephone during a thunderstorm.** There might be a slight chance of electric shock from lightning.
- **Do not use the telephone to report a gas leak in the vicinity of the leak.** Under certain circumstances, a spark may be created when the adapter is plugged into the power outlet, or when the handset is replaced in its cradle. This is a common event associated with the closing of any electrical circuit. In an inadequately ventilated environment, the user should not plug the phone into a power outlet, nor put a charged handset into the cradle where there are concentrations of flammable or flame-supporting gases. A spark in such an environment could create a fire or explosion. Such environments might include: medical use of oxygen without adequate ventilation; industrial gases (cleaning solvents; gasoline vapors; etc.); a leak of natural gas; etc.
- **Do not use this product near water or when you are wet.** For example, do not use it in a wet basement or shower, nor next to a swimming pool, bathtub, kitchen sink, and laundry tub. Do not use liquids or aerosol sprays for cleaning. If the product comes in contact with any liquids, unplug any line or power cord immediately. Do not plug the product back in until it has dried thoroughly.
- **Install this product in a protected location** where no one can trip over any line or power cords. Protect cords from damage or abrasion.
- **If this product does not operate normally, read Troubleshooting on pages 62-66 of this user's manual.** If you cannot solve the problem, or if the product is damaged, refer to **Limited warranty** on pages 74-75. Do not open this product except as may be directed in your user's manual. Opening the product or reassembling it incorrectly may expose you to hazardous voltages or other risks.
- **If this product has user-replaceable batteries, replace batteries only as described in your user's manual (page 4).** Do not burn or puncture batteries—they contain caustic chemicals.
- **If this product has a three-prong (grounding) plug or a polarized plug with one wide prong, it might not fit in outlets that are not polarized.** Do not defeat the purpose of these plugs. If they do not fit in your outlet, the outlet should be replaced by an electrician.



CAUTION: Use only the power adapter provided with this product. To obtain a replacement, visit our website at **www.telephones.att.com**, or call **1 (800) 222-3111**. In Canada, dial **1 (866) 288-4268**.

Especially about corded telephones

- **Electrical power:** The telephone base must be connected to a working electrical outlet. The electrical outlet should not be controlled by a wall switch. **Calls cannot be made from the handset if the telephone base is unplugged, switched off, or if the electrical power is interrupted.**
- **Power adapter:** The power adapter is intended to be correctly oriented in a vertical or floor mount position. The prongs are not designed to hold the plug in place if it is plugged into a ceiling, under-the-table or cabinet outlet.

SAVE THESE INSTRUCTIONS

For C-UL compliance

In compliance with the bilingual requirements for safety, caution, and warning markings of Canadian Federal and Provincial/Territorial statutes and regulations, the French version of Important safety information is included.

Mesures de sécurité importantes



Ce symbole vous alertera d'informations importantes ou d'instructions d'entretien pouvant apparaître dans ce guide d'utilisation. Respectez toujours les mesures de sécurité et de sécurité de base lorsque vous utilisez ce produit, afin de réduire les risques de blessures, d'incendie, ou d'électrocution.

Information relative à la sécurité

- **Veillez lire et comprendre toutes les instructions de ce guide d'utilisation. Relectez toutes les inscriptions apparaissant sur le produit.**
- **Évitez d'utiliser le téléphone pendant un orage.** Il pourrait y avoir un faible risque d'électrocution.
- **N'utilisez pas un téléphone près d'une fuite de gaz.** Dans certaines circonstances, une flammèche pourrait se produire lorsque l'adaptateur est branché à une prise de courant, ou lorsque le combiné est déposé sur son chargeur. Ceci est un événement fréquent associé avec la fermeture d'un circuit électrique. L'utilisateur ne devrait pas brancher un téléphone dans une prise de courant, et ne devrait pas déposer un combiné chargé dans le chargeur, si le téléphone se trouve dans un environnement comportant une concentration de gaz inflammables ou ignifuges, à moins de se trouver dans un endroit où la ventilation est adéquate. Une flammèche dans de tels environnements pourrait provoquer une explosion. De tels environnements peuvent comprendre : les endroits où de l'oxygène à des fins médicales est utilisé sans ventilation adéquate; des endroits où se trouvent des gaz industriels (dissolvants de nettoyage, des vapeurs de gazoline, etc.), une fuite de gaz naturel, etc.
- **N'utilisez pas ce produit près de l'eau ou lorsque vous êtes mouillés.** Par exemple, ne l'utilisez pas dans des sous-sols humides ou sous la douche, ou près d'une piscine, d'un bain, d'un évier de cuisine, ou d'une cuve de lavage. N'utilisez pas de liquides, ou de vaporisateurs aérosol de nettoyage. Si le produit entre en contact avec du liquide, débranchez immédiatement le fil téléphonique ou le cordon d'alimentation. Ne rebranchez pas le produit avant qu'il soit complètement sec.
- **Installez cet appareil dans un endroit protégé** où personne ne peut trébucher sur les cordons d'alimentation ou la ligne téléphonique. Protégez les câbles contre les dommages ou l'abrasion.
- **Si le produit ne fonctionne pas correctement, consultez la section Dépannage (Troubleshooting) des pages 62-66 de ce guide d'utilisation.** Si vous ne pouvez pas régler le problème, ou si le produit est endommagé, consultez la section **Garantie limitée (Limited warranty)** des pages 74-75. N'ouvrez pas ce produit, sauf tel qu'indiqué dans le guide d'utilisation. L'ouverture du produit ou le remontage inadéquat pourrait vous exposer à des tensions dangereuses ou autres dangers.
- **Remplacez les piles uniquement tel que décrit dans votre guide d'utilisation (page 4).** N'incinerez pas et ne percez pas les piles — elles contiennent des produits chimiques caustiques.
- **Cet appareil est doté d'une fiche à trois broches (de mise à la terre) ou une fiche polarisée avec une lame plus large, elle risque de ne pas s'insérer dans une prise de courant non polarisée.** Ne tentez pas d'outrepasser les broches. Si la fiche ne s'insère pas dans votre prise de courant, celle-ci doit être remplacée par un électricien.

For C-UL compliance



MISES EN GARDE: N'utilisez seulement l'adaptateur inclus avec ce produit. Pour obtenir une pièce de rechange, visitez notre site Web au **www.telephones.att.com** ou composez le **1-800-222-3111**. Au Canada, composez le **1-866-288-4268**.

Spécifiquement en rapport avec les téléphones avec fil

- **Alimentation électrique :** La base de ce téléphone doit être branchée à une prise de courant électrique fonctionnelle. La prise électrique ne doit pas être contrôlée par un interrupteur mural. **Les appels ne peuvent pas être effectués à partir du combiné si la base n'est pas branchée, si elle est hors fonction ou si le courant électrique est coupé.**
- **L'adaptateur:** L'adaptateur de courant est conçu pour être orienté verticalement ou installé sur le plancher. Les broches ne sont pas conçues pour se maintenir en place si la fiche est branchée dans une prise de courant au plafond, sous la table ou sous une armoire.

CONSERVEZ CES INSTRUCTIONS

FCC and ACTA information

If this equipment was approved for connection to the telephone network prior to July 23, 2001, it complies with Part 68 of the Federal Communications Commission (FCC) rules. If the equipment was approved after that date, it complies with the Part 68 rules and with the Technical Requirements for Connection of Equipment to the Telephone Network adopted by the Administrative Council for Terminal Attachments (ACTA). We are required to provide you with the following information.

1. Product identifier and REN information

The label on the back or bottom of this equipment contains, among other things, an identifier indicating product approval and the Ringer Equivalence Number (REN). This information must be provided to your telephone service provider upon request. For equipment approved prior to July 23, 2001, the product identifier is preceded by the phrase "FCC Reg No." and the REN is listed separately. For equipment approved after that date, the product identifier is preceded by "US" and a colon (:), and the REN is encoded in the product identifier without a decimal point as the sixth and seventh characters following the colon. For example, the product identifier US:AAAEQ03T123XYZ indicates the REN would be 0.3.

The REN is used to determine how many devices you can connect to your telephone line and still have them ring when you are called. In most, but not all areas, the sum of all RENs should be five (5.0) or less. You might want to contact your telephone service provider for more information.

2. Connection and use with the nationwide telephone network

The plug and jack used to connect this equipment to the premises wiring and the telephone network must comply with the applicable Part 68 rules and technical requirements adopted by ACTA. A compliant telephone cord and modular plug is provided with this product. It is designed to be connected to a compatible modular wall jack that is also compliant. An RJ11 jack should normally be used for connecting to a single line and an RJ14 jack for two lines, see installation instructions in the user's manual. This equipment may not be used with coin telephone lines or with party lines. If you have specially wired alarm dialing equipment connected to your telephone line, ensure the connection of this equipment does not disable your alarm equipment. If you have questions about what will disable the alarm equipment, consult your telephone service provider or qualified installer.

3. Repair instructions

If this equipment is malfunctioning, it must be unplugged from the modular wall jack until the problem has been corrected. Repairs to this telephone equipment can only be made by the manufacturer or its authorized agents. For repair procedures, follow the instructions outlined under the limited warranty.

4. Rights of the telephone service provider

If this equipment is causing harm to the telephone network, the telephone service provider may temporarily discontinue your telephone service. The telephone service provider is required to notify you before interrupting service. If advance notice is not practical, you will be notified as soon as possible. You will be given the opportunity to correct the problem and the telephone service provider is required to inform you of your right to file a complaint with the FCC. Your telephone service provider may make changes in its facilities, equipment, operation, or procedures that could affect the proper functioning of this product. The telephone service provider is required to notify you if such changes are planned.

5. Hearing aid compatibility

If this product is equipped with a corded or cordless handset, it is hearing aid compatible.

FCC and ACTA information

6. Programming/testing of emergency numbers

If this product has memory dialing locations, you may choose to store police, fire department and emergency medical service telephone numbers in these locations. If you do, please keep three things in mind:

- a. We recommend that you also write the telephone number on the directory card (if applicable), so that you can still dial the emergency number manually if the memory dialing feature doesn't work.
- b. This feature is provided only as a convenience, and the manufacturer assumes no responsibility for customer reliance upon the memory feature.
- c. Testing the emergency telephone numbers you have stored is not recommended. However, if you do make a call to an emergency number:
 - You must remain on the line and briefly explain the reason for the call before hanging up.
 - Programming/testing of emergency numbers should be performed during off-peak hours, such as in the early morning or late evening, when the emergency services tend to be less busy.

Part 15 of FCC rules

Some telephone equipment generates, uses, and can radiate radio-frequency energy and, if not installed and used properly, may cause interference to radio and television reception. This product has been tested and found to meet the standards for a class B digital device, as specified in Part 15 of the FCC rules.

These specifications are designed to provide reasonable protection against such interference in a residential installation. However, there is no guarantee that interference will not occur in a particular installation.

If this product causes interference to radio, VCR or television reception when it is in use, you might correct the interference with any one or all of these measures:

- Where it can be done safely, reorient the receiving radio, VCR or television antenna.
- To the extent possible, relocate the radio, VCR, television or other receiver with respect to the telephone equipment.
- If this telephone product runs on AC power, plug your product into an AC outlet that's not on the same circuit as one used by your radio, VCR or television.
- Consult a dealer or an experienced radio/TV technician for help.

This device complies with Part 15 of the FCC Rules. Operation is subject to the following two conditions: (1) this device may not cause harmful interference, and (2) this device must accept any interference received, including interference that may cause undesired operation.

Warning: Changes or modifications to this unit not expressly approved by the party responsible for compliance could void the user's authority to operate the equipment.

This product meets the applicable Industry Canada technical specifications.

The Ringer Equivalence Number (REN) for this terminal equipment is 0.4. The REN is an indication of the maximum number of devices allowed to be connected to a telephone interface. The termination on an interface may consist of any combination of devices subject only to the requirement that the sum of the RENs of all the devices does not exceed five.

This Class B digital apparatus complies with Canadian requirement:

CAN ICES-3 (B)/NMB-3(B)

Limited warranty

The AT&T brand is used under license - any repair, replacement or warranty service, and all questions about this product should be directed to: In the United States of America, call **1 (800) 222-3111** or visit **www.telephones.att.com**. In Canada, dial **1 (866) 288-4268**.

1. What does this limited warranty cover?

The manufacturer of this AT&T branded product warrants to the holder of a valid proof of purchase (“CONSUMER” or “you”) that the product and all accessories provided in the sales package (“PRODUCT”) are free from defects in material and workmanship, pursuant to the following terms and conditions, when installed and used normally and in accordance with the PRODUCT operating instructions. This limited warranty extends only to the CONSUMER for products purchased and used in the United States of America and Canada.

2. What will be done if the PRODUCT is not free from defects in materials and workmanship during the limited warranty period (“materially defective PRODUCT”)?

During the limited warranty period, the manufacturer’s authorized service representative repairs or replaces at the manufacturer’s option, without charge, a materially defective PRODUCT. If the manufacturer repairs the PRODUCT, they may use new or refurbished replacement parts. If the manufacturer chooses to replace the PRODUCT, they may replace it with a new or refurbished PRODUCT of the same or similar design. The manufacturer retains the defective parts, modules, or equipment. Repair or replacement of the PRODUCT, at the manufacturer’s option, is your exclusive remedy. The manufacturer returns the repaired or replacement products to you in working condition. You should expect the repair or replacement to take approximately 30 days.

3. How long is the limited warranty period?

The limited warranty period for the PRODUCT extends for ONE (1) YEAR from the date of purchase. If the manufacturer repairs or replaces a materially defective PRODUCT under the terms of this limited warranty, this limited warranty also applies to repaired or replacement PRODUCT for a period of either (a) 90 days from the date the repaired or replacement PRODUCT is shipped to you or (b) the time remaining on the original one-year limited warranty; whichever is longer.

4. What is not covered by this limited warranty?

This limited warranty does not cover:

- PRODUCT that has been subjected to misuse, accident, shipping or other physical damage, improper installation, abnormal operation or handling, neglect, inundation, fire, water, or other liquid intrusion; or
- PRODUCT that has been damaged due to repair, alteration, or modification by anyone other than an authorized service representative of the manufacturer; or
- PRODUCT to the extent that the problem experienced is caused by signal conditions, network reliability or cable or antenna systems; or
- PRODUCT to the extent that the problem is caused by use with non-AT&T accessories; or
- PRODUCT whose warranty/quality stickers, PRODUCT serial number plates or electronic serial numbers have been removed, altered or rendered illegible; or
- PRODUCT purchased, used, serviced, or shipped for repair from outside the United States of America or Canada, or used for commercial or institutional purposes (including but not limited to products used for rental purposes); or
- PRODUCT returned without a valid proof of purchase (see item 6); or
- Charges for installation or setup, adjustment of customer controls, and installation or repair of systems outside the unit.

Limited warranty

5. How do you get warranty service?

To obtain warranty service in the United States of America, visit

www.telephones.att.com or call **1 (800) 222-3111**. In Canada, please dial **1 (866) 288-4268**. NOTE: Before calling for service, please review the user's manual. A check of the PRODUCT's controls and features might save you a service call.

Except as provided by applicable law, you assume the risk of loss or damage during transit and transportation and are responsible for delivery or handling charges incurred in the transport of the PRODUCT(s) to the service location. The manufacturer will return repaired or replaced PRODUCT under this limited warranty. Transportation, delivery or handling charges are prepaid. The manufacturer assumes no risk for damage or loss of the PRODUCT in transit. If the PRODUCT failure is not covered by this limited warranty, or proof of purchase does not meet the terms of this limited warranty, the manufacturer notifies you and requests that you authorize the cost of repair prior to any further repair activity. You must pay for the cost of repair and return shipping costs for the repair of products that are not covered by this limited warranty.

6. What must you return with the PRODUCT to get warranty service?

You must:

- Return the entire original package and contents including the PRODUCT to the service location along with a description of the malfunction or difficulty; and
- Include a "valid proof of purchase" (sales receipt) identifying the PRODUCT purchased (PRODUCT model) and the date of purchase or receipt; and
- Provide your name, complete and correct mailing address, and telephone number.

7. Other limitations

This warranty is the complete and exclusive agreement between you and the manufacturer of this AT&T branded PRODUCT. It supersedes all other written or oral communications related to this PRODUCT. The manufacturer provides no other warranties for this PRODUCT. The warranty exclusively describes all of the manufacturer's responsibilities regarding the PRODUCT. There are no other express warranties. No one is authorized to make modifications to this limited warranty and you should not rely on any such modification.

State/Provincial Law Rights: This warranty gives you specific legal rights, and you might also have other rights that vary from state to state or province to province.

Limitations: Implied warranties, including those of fitness for a particular purpose and merchantability (an unwritten warranty that the PRODUCT is fit for ordinary use) are limited to one year from date of purchase. Some states/provinces do not allow limitations on how long an implied warranty lasts, so the above limitation might not apply to you. In no event shall the manufacturer be liable for any indirect, special, incidental, consequential, or similar damages (including, but not limited to lost profits or revenue, inability to use the PRODUCT or other associated equipment, the cost of substitute equipment, and claims by third parties) resulting from the use of this PRODUCT. Some states/provinces do not allow the exclusion or limitation of incidental or consequential damages, so the above limitation or exclusion might not apply to you.

Please retain your original sales receipt as proof of purchase.

Technical specifications

Operating temperature	32°F — 122°F 0°C — 50°C
Power adapter	input: 100-120V AC 60Hz output: 6V DC 400mA
Optional backup batteries	three 1.5V alkaline batteries

Index

A

- Alert tones, 59
- Annc A time, 48
- Annc B time, 48
- Announcement A, B
 - Delete, 47
 - Play, 47
 - Record, 47
- Answer a call, 23
- Answering system, 53–57
- Answer on/off, 49
- Automatic line selection, 18
- Auto redial, 26
- Auto speaker, 18

C

- Call intercept, 54
- Call screening, 50, 54
- Call waiting, 27, 39
- Caller ID
 - Delete entries, 42
 - Dial an entry, 42
 - Dialing options, 42
 - Reviewing call history, 41
 - Save entries to speed dial, 44
 - Save entries to the directory, 43
- Caller ID history (call log), 40
- Chain dialing, 30
- Character chart, 35
- Clearspeak, 24
- Clear voicemail indication, 21
- Clock, 16
- Conference calls, 28
- COVM (central office voicemail), 22

D

- Data port, 8
- Date and time, 16

- Delete all old messages, 56
- Directory
 - Capacity, 35
 - Create entries, 36
 - Delete entries, 38
 - Dial entries, 38
 - Review entries, 36
 - Save entries to speed dial, 38
 - Search entries, 37

- DSL, 1, 6–7

E

- Edit entries, 37
- End a call, 23

F

- Flash, 27

G

- General product care, 67

H

- Hold, 27
- Home area code, 19

I

- Important safety information, 68
- Incoming message length, 51
- Indicator lights, 58

K

- Key tone, 17

L

- Last number redial, 25
- LCD backlight, 16
- LCD language, 16
- Limited warranty, 74–75
- Local area code, 19

Index

M

- Make a call, 23
- Memory match, 41
- Memos, 56
- Message alert tone, 52
- Message capacity, 54
- Message playback, 55
- Missed calls indicator, 41
- Mute, 27

N

- New message indication, 54
- Number of rings, 50

O

- On hook dialing, 24
- Optional backup battery installation, 4

P

- Predialing, 24
- Preferred mode, 19
- Primary line, 18
- Priority code, 52, 54
- Pulse dialing, 20

Q

- Quick reference guide, 2–3

R

- Record memos, 56
- Redial
 - Copy the redial entry to speed dial, 25
 - Dial the redial entry, 25
- Remote access, 57
- Remote code, 51
- Repeat calls, 20
- Ringer melody, 15
- Ringer volume, 15

S

- Safety information, 68
- Screen display messages, 60–61
- Screen icons, 58
- Scroll rate, 17
- Special caller ID messages, 45
- Speed dial
 - Delete a number, 34
 - Dial a number, 33
 - Edit a number, 33
 - Review a number, 32
 - Store a number, 32
- Speed dial memory, 31
- Switching between lines, 28

T

- Tabletop installation, 9–11
- Technical specifications, 76
- Telephone base installation, 5–7
- Temporary ringer silencing, 24
- Temporary tone dialing, 28
- Toll saver, 50
- Tone dialing, 20
- Troubleshooting, 62–66
- Two-way recording, 29

V

- Voicemail, 53
- Voicemail indicator, 21
- Voice prompts, 46
- Volume, 15, 27, 55

W

- Wall installation, 9–11
- Warranty, 74–75

Remote access wallet card

The following wallet card lists the commands needed to control your answering system from any touch-tone telephone.

Cut along dotted line.



Call your telephone number, then enter your three-digit remote access code (preset to **500**).

Action	Remote command
Play all messages.....	1
Play new messages.....	2
Delete the message	3
Delete all old messages.....	33
Repeat or go back	4
Listen to the previous messages	44
Stop	5
Hear a list of remote commands.....	*5
Skip to the next message.....	6
Record new announcement A.....	*7
Record new announcement B.....	*8
End the call	*9
Turn the answering system on or off	0

Fold here.

ML17939 Two-line corded telephone/answering system with caller ID/call waiting

© 2010-2016 Advanced American Telephones. All Rights Reserved.
AT&T and the AT&T logo are trademarks of AT&T Intellectual Property licensed to Advanced American Telephones, San Antonio, TX 78219.
Printed in China.



www.telephones.att.com

Clearspeak® is a registered trademark of Advanced American Telephones.
© 2010-2016 Advanced American Telephones. All Rights Reserved.
AT&T and the AT&T logo are trademarks of AT&T Intellectual Property licensed to
Advanced American Telephones, San Antonio, TX 78219.
Printed in China. Issue 13.0 AT&T 12/16.