

ES900

USER'S MANUAL



WARNING

This equipment has been tested and found to comply with the limits for a Class A digital device, pursuant to Part 15 of FCC Rules. These limits are designed to provide reasonable protection against harmful interference when the equipment is operated in a commercial environment. This equipment generates, uses and can radiate radio frequency energy and, if not installed and used in accordance with the instruction manual, may cause harmful interference to radio communications. Operation of this equipment in a residential area is likely to cause harmful interference in which case the user will be required to correct the interference at his or her own expense.

Caution: Changes or modifications not expressly approved by the party responsible for compliance could void the user's authority to operate the equipment.

THIS DIGITAL APPARATUS DOES NOT EXCEED THE CLASS A LIMITS FOR RADIO NOISE EMISSIONS FROM DIGITAL APPARATUS AS SET OUT IN THE RADIO INTERFERENCE REGULATIONS OF THE CANADIAN DEPARTMENT OF COMMUNICATIONS.

LE PRÉSENT APPAREIL NUMÉRIQUE N'EXCÈDE PAS LES LIMITES APPLICABLES AUX APPAREILS NUMÉRIQUES DE CLASSE A PRÉSCRITES DANS LE RÈGLEMENT SUR LE BROUILLAGE RADIOÉLECTRIQUE ÉDICTÉ PAR LE MINISTÈRE DES COMMUNICATIONS DU CANADA.

Information contained in this manual is company private to Acroprint Time Recorder Co., and shall not be modified, used, copied, reproduced or disclosed in whole or in part without the written consent of Acroprint.

Contents herein are current as of the date of publication. Acroprint reserves the right to change the contents without prior notice.

This manual has been carefully prepared to cover all aspects of this unit. However, if any explanations are inadequate, unclear, or difficult to understand, please contact Acroprint.

We recommend that you carefully read this manual to maximize the use of this unit.

© 2008 Acroprint Time Recorder Co.
All Rights Reserved.

Serial Number label for bottom of clock



5640 Departure Dr. • Raleigh, NC 27616 USA
IN USA 800.334.7190

ES900

Voltage: XXVAC 60Hz
Wattage: XXA
Serial No.:51nnnncc



0 1 0 1 8 2 0 0 0 5 1 X X X X X X X



LISTED
E220359

This equipment complies with Part 15 of FCC Rules. Operation is subject to the following two conditions: (1) This device may not cause harmful interference, and (2) must accept any harmful interference received, including interference that may cause undesired operation.

Table of Contents

Alert Definitions	iii
Precautions	iv
Introduction	1
Main Features	1
Optional Features	1
Equipment	2
ES900	2
Open and Close Unit	3
Power the Unit/Print Positioning	5
Important Things to Remember When Using The ES900	6
Quick Start	7
Atomic Synchronization	7
Set Time Zone (-5 EST, -6 CST, -7 MST, -8 PST)	7
Automatically Receive Atomic Signal	7
Turn DST OFF	7
Program the Time Recorder	9
Main Settings	10
Time	10
Date	11
12/24 Hour Format	12
Print Order	13
Print Pattern	15
Preset Comments	17
Language	18
Print Method	19
Daylight Saving Time (DST)	22
Numbering Print	26
Initial Number	29
Set Password	31
Enter Password	32



Cancel the Password 32

Customized Comments 33

Confirming/Changing Customized Comments 42

Time Table Program Features 46

Confirm Time Table Program Settings 52

Delete Time Table Program Settings 52

Optional Installation/Connections 55

 Connecting the External Time Signal 55

 Installing the Ni-Cd Battery 56

 Attaching the Wire Clamp 57

Reset Factory Default Settings 59

Wall Mounting 61

Replacing the Ribbon Cassette 62

Character Code for Alphanumeric 64

 Large (Bold) Character 65

 Large Character 66

 Small Character 67







 Language-Specific Character 68

Troubleshooting 69





Specifications 70

ALERT DEFINITIONS

For your safety and the protection of the unit, the following alerts are used throughout this manual.

READER ALERT	MEANING
	Alerts you to supplementary information.
	Alerts you to helpful tips (information given as a guide to action).
IMPORTANT 	Alerts you to supplementary information that is essential to the completion of a task.
CAUTION	Alerts you to possible data loss, breaches of security, or other more serious problems.
WARNING	Alerts you that failure to take or avoid a specific action might result in physical harm to you or to the hardware.
	Alerts you to stop immediately. Failure to do so will result in physical harm to you or to the hardware.
DANGER	Alerts you that improper handling may cause electrical shock resulting in serious injury or death.
	Alerts you not to disassemble or modify the unit.
	Alerts you to remove power cord from wall outlet.
	Alerts you “do not” perform an action.

PRECAUTIONS

ALERT	DESCRIPTION
<p><u>IMPORTANT</u></p> 	<ul style="list-style-type: none"> • Insert the power plug as far as it will go. Improper insertion of the plug may result in fire or electric shock.
	<ul style="list-style-type: none"> • Do not disassemble the unit. High voltage is present inside that may lead to an electric shock. • Do not modify the unit. Modifications may cause a fire and/or electric shock.
	<ul style="list-style-type: none"> • Do not use any voltage of the power source other than designated. • Do not share a single outlet with another plug. This may lead to a fire or electric shock. • Do not damage, break, or modify the power cord. • Do not put heavy objects on, pull, or forcefully bend the cord. These may damage the cord, possibly resulting in a fire or electric shock. • Do not plug or unplug the unit with a wet hand. This may lead to an electric shock. • Do not place the unit on an uneven or tilted surface. This may result in injuries due to the unit dropping or falling off. • Do not put a water-filled container or a metal object on top of the unit. If water is spilled or the metallic object slips inside, a fire or electric shock may occur. • Do not install the unit in a humid or dusty environment. This may result in a fire or electric shock. • Do not place the unit near a kitchen counter or humidifier. Oil, smoke, or steam generating from them may cause fire or electric shock. • Do not yank the power cord to disconnect from the outlet. Hold the plug with your hand to do so, or the cord may be damaged. This may lead to a fire or electric shock. • Do not insert or drop any other time card than specified into the slot. Such misuse may cause a fire or electric shock. • Do not come in contact with the print head. This may result in personal injury.
	<ul style="list-style-type: none"> • If any anomaly occurs, for example, heat or smoke is generated or an odor is emitted, unplug the unit immediately and contact your dealer for servicing. There is a danger that further use may cause a fire or electric shock. • If foreign matter should get in the unit (including a piece of metal, water, or liquid), disconnect the plug from the outlet immediately and contact your dealer for servicing. There is a danger that further use may cause a fire or electric shock. • Remove the line cord plug from the outlet before transferring the unit, or it may damage the cord. This may lead to a fire or electric shock. • If the unit should be dropped or the case is broken, unplug the unit and contact your dealer for servicing. Further use may lead to a fire or electric shock.

INTRODUCTION

Thank you for purchasing an Acroprint Model ES900 Time Recorder. We are confident this unit will give you full satisfaction. Items such as the time and date are preset at the factory. After plugging in the power cord to the wall outlet, this unit can be used. However, we recommend reading this manual before you start using this unit.

MAIN FEATURES

Main Applications: Payroll/job cost recorder, time recorder or numbering machine.

- Atomic Synchronization Sets Time and Date Automatically
- Combines Time Recorder, Time Stamp, Numbering Machine – Multi-Purpose/ Multi-Functions
- Quartz Time Recorder
- Digital LCD (Date, Hour, Minute, Day of the Week)
- Perpetual Calendar
- Dot-Matrix Printer
- Automatic Daylight Saving Time (DST)
- Automatic Date, Month Year Change to 2099
- 4-way Print Activation
 - o Automatic
 - o Semi-Automatic
 - o Manual
 - o Combination
- Durable Snap-in Ribbon Cartridge
- Adjustable Print Positions
- Prints in 7 languages
- Prints Date
- Preset or Custom Comments
- 13 Preset Comments
- Selectable 4-Digit Year Imprint
- 12 or 24-Hour Format
- Regular Minute, Tenths, Twentieths, or Hundredths of an Hour
- Password Protection
- Built-in Battery Backup
- Wall or Desktop Mount

OPTIONAL FEATURES

- Time Table Program
- I-Mark™ Printing (Irregular Registration Mark)
- Program Internal Signal or Activate External Time Signal
- Built-in Buzzer
- Rechargeable Battery for Punching without AC Power

EQUIPMENT

Unpack the unit and check its contents to ensure that the time recorder unit and all accessories shown below are included. If equipment has been damaged in transit, report the extent of damage to the transportation company and to Acroprint. Order replacement equipment, if necessary.

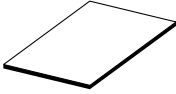

ES900 Manual (1)

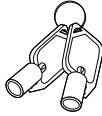

Keys (2)

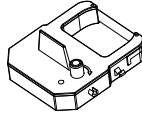

**Ribbon Cassette (1)
Factory Installed**

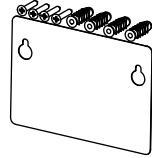

**Wall-Mount Fittings
(4 Screws, 4 Mollies,
1 Sheet)**



**Wall Brackets (2)
(2 Screws)**

ES900

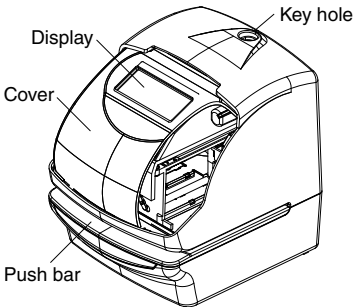

Front View (with Cover)

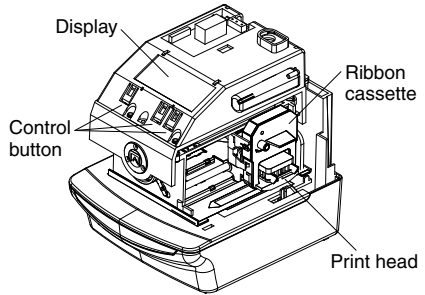

Front View (without Cover)

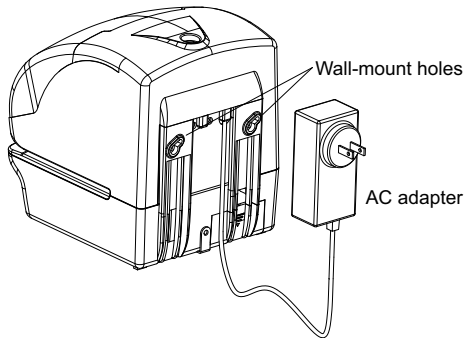

Back View

Open and Close Unit

Open Unit

Insert the key into the lock on cover of the unit. Turn the key in the clockwise position to unlock the unit. Remove the cover. Refer to [Open Unit](#) below.

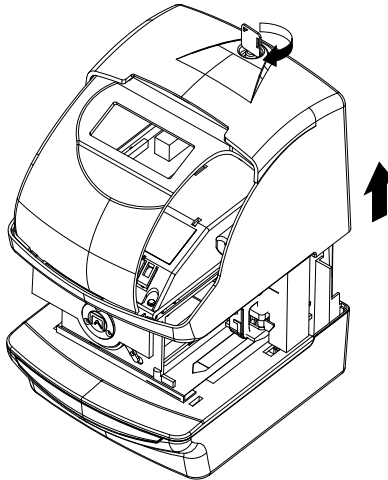

Open Unit



When you open the unit for the first time, you must remove the **Protective Pad and Cardboard Insert**. Plug the AC Adapter into the back of the unit. Refer to [Remove Protective Pad and Cardboard Insert/Plug AC Adapter into Unit](#) on page 4.

CAUTION

Ribbon May Dislodge. To avoid damage to the printer, press the ribbon cartridge firmly into position after removing the protective pad. Refer to [Remove Protective Pad and Cardboard Insert/Plug AC Adapter into Unit](#) on page 4.

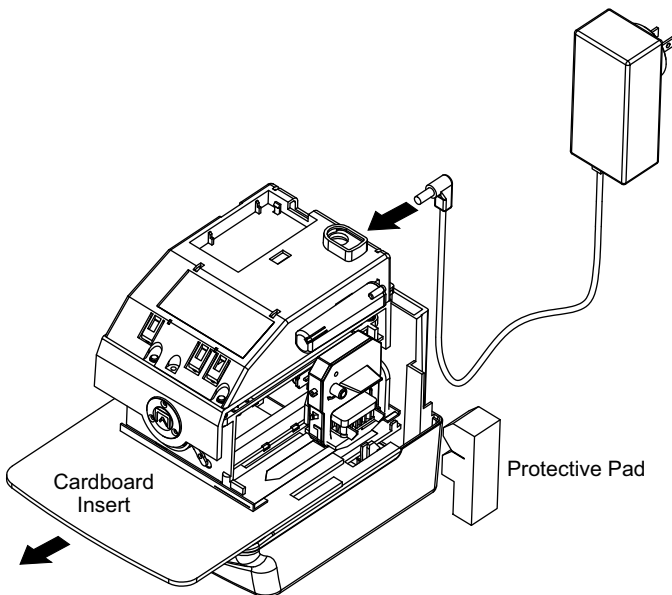

Remove Protective Pad and Cardboard Insert/Plug AC Adapter into Unit

Close Unit

Replace the cover. Insert the key into the lock on the cover of the unit. Turn the key in the counter-clockwise position to lock the unit. Refer to [Close Unit](#) below.

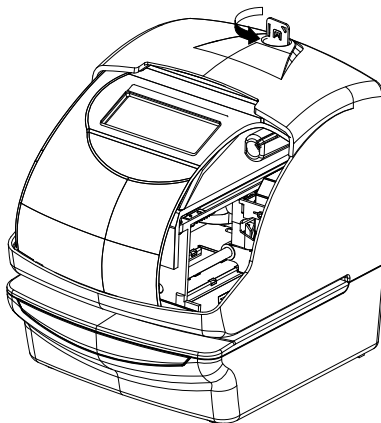

Close Unit

Power the Unit/Print Positioning

Plug the transformer into the AC outlet. Insert a card to get a sample print. Refer to [Power the Unit](#) below.

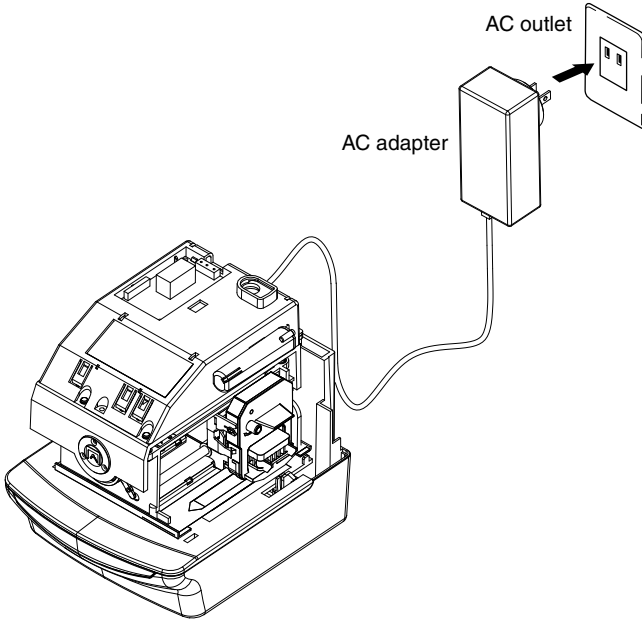

Power the Unit

Print position from the card edge is adjustable by pressing and sliding the print position button located on the right outside bottom of the unit. Maximum distance from edge of form to print is approximately 1-3/16" (30 mm). Refer to [Print Position on Time Card](#) below.

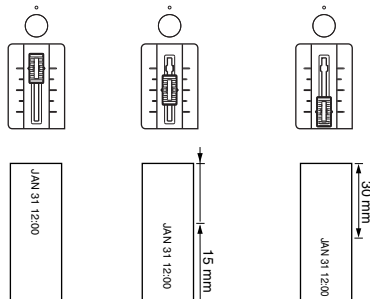

Print Position on Time Card

IMPORTANT THINGS TO REMEMBER WHEN USING THE ES900

IMPORTANT



You must open the unit to make changes to the settings. After each use, replace the cover and lock it. Refer to “Open and Close Unit” on page 3.

After performing each procedure on the unit, remember to press **SET** until the unit returns to normal operation mode. To exit program mode anytime, press **SET** until the unit returns to normal operation mode.



When you are setting a digit or an option on the display, flashing means that it is ready to be changed. You must press **SELECT** until you reach the desired digit or option. Then press **SET** to lock the desired value in place.

Printing is always disabled while settings are being changed. Once the final **SET** has been completed in any given operation, printing is enabled.

QUICK START

Atomic Synchronization

The clock receives the NIST WWVB Signal which will automatically set the time and date. Refer to Atomic Synchronization Time Zones on page 8.

For more information about the WWVB Radio Signal (Atomic Signal), visit NIST's website at: www.boulder.nist.gov.



Daylight Saving Time (DST) defaults to AUTOMATIC.

If you are in the EST Time Zone and observe DST, the Atomic Synchronization should work automatically after the AC cord has been plugged into the AC outlet overnight.

Set Time Zone (-5 EST, -6 CST, -7 MST, -8 PST)

1. Press **SELECT** until the arrow points to Time Zone.
2. Press **CHANGE** until your Time Zone appears (see Time Zones on page 8).
3. Press **SET**.

Automatically Receive Atomic Signal

1. Plug the transformer into the AC outlet overnight.
2. If the Atomic Clock Symbol indicator is on in the morning, your clock is receiving the atomic clock signal and the time and date should be set properly.



Atomic Synchronization Symbol Indicator

3. If you did not receive the atomic signal, try repositioning the clock or set the unit manually as described above.



If you do not observe DST, follow the procedure below to turn DST off.

Turn DST OFF

1. Press **SELECT** (twice). Arrow points to DST.
2. Press **CHANGE** until "2" is displayed.
3. Press **SET**.

Atomic Synchronization Time Zones

Default = ES-05

DISPLAY TIME ZONE	DESCRIPTION
12	
11	
10	
09	
08	
07	
06	
05	
04	
03	
02	
01	
00	Greenwich
-01	
-02	
-03	
-04	Atlantic Standard Time
ES-05 (Default)	Eastern Standard Time
CS-06	Central Standard Time
-07	Mountain Standard Time
PS-08	Pacific Standard Time
AS-09	Alaska Standard Time
HS-10	Hawaiian Standard Time
-11	
-12	

PROGRAM THE TIME RECORDER

IMPORTANT



Most of the procedures in this manual are performed from the Time Recorder menu. Refer to Time Recorder Menu below. Refer to Time Recorder Function Buttons below.

Press **SELECT**. The unit changes into the program mode showing ▲ on the display positioned under the "TIME" mark.

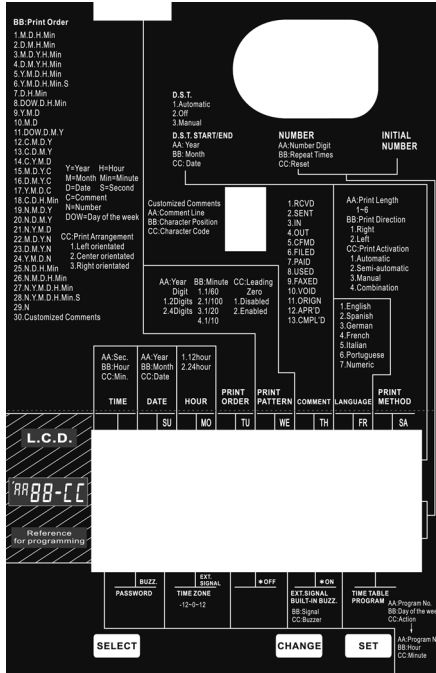

Time Recorder Menu

Time Recorder Function Buttons

CONTROL	FUNCTION
SELECT	Press SELECT to choose the desired program setting mode. The selected program mode is indicated by ▲ on the display.
CHANGE	Press CHANGE to cycle through the options.
SET	Press SET to set the option. After an option has been set, always press SET again to return the unit to normal operation mode.

MAIN SETTINGS

Time



Set the Time Zone before setting the Time (see Set Time Zone on page 7). Changing the Time Zone will change the Time.

Example: Change the time from 9:08 AM to 10:09 AM.

1. Press **SELECT** until the ▲ is under the "TIME" mark.
2. "Hour" flashes.

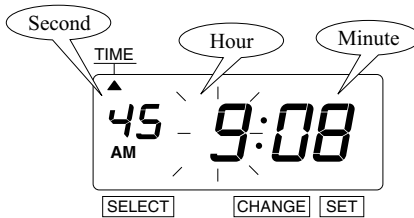

Change Hour

1. Press **CHANGE** until the Hour is "10".
2. Press **SET**.
3. The flashing changes from "Hour" to "Minute".



Change Minute

1. Press **CHANGE** until the Minute is "09".
2. Press **SET**.
3. The "Second" starts to run from "00".

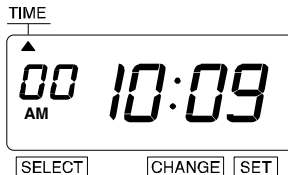

Date

Example: Change the date from September 20, 2007 to October 21, 2008.

1. Press **SELECT** until the ▲ is under the "DATE" mark.
2. "Year" flashes.

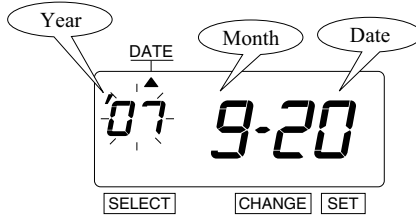

Change Year

1. Press **CHANGE** until the Year is "08".
2. Press **SET**.
3. The flashing changes from "Year" to "Month".

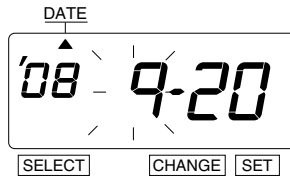

Change Month

1. Press **CHANGE** until the Month is "10".
2. Press **SET**.
3. The flashing changes from "Month" to "Date".

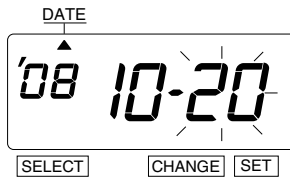

Change Date

1. Press **CHANGE** until the Date is "21".
2. Press **SET**.

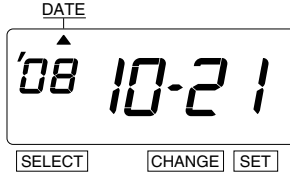

12/24 Hour Format

Example: Change the hour format from 12 hour format to 24 hour format.

1. Press **SELECT** until the ▲ is under the "HOUR" mark.
2. The flashing digit indicates "Hour Display Format Options".

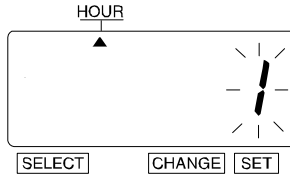

Change Hour

1. In this example, press **CHANGE** until the option is "2" (24 Hour Format). Refer to Hour Display Options below.
2. Press **SET**.

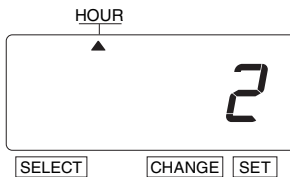

Hour Display Options

OPTION	HOUR DISPLAY FORMAT OPTIONS	DISPLAY
1	12 Hour	PM 3:00
2	24 Hour	15:00

Print Order

Example: Set the print order to "Month, Date, Year, Hour, Minute".

1. Press **SELECT** until the ▲ is under the "PRINT ORDER" mark.
2. The flashing digit indicates "Print Order Options".

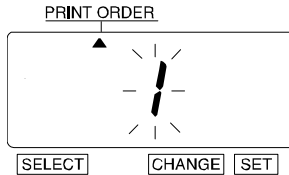

3. Refer to Print Order Options on page 14.
4. In this example, press **CHANGE** until the option is "3" (M.D.Y.H.Min.).
5. Press **SET**.

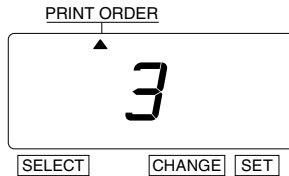

Legend

Y = Year
M = Month
D = Date
DOW = Day of the Week
H = Hour
Min = Minute
S = Second
C = Comment
N = Number

Print Order Options

OPTION	PRINT ORDER OPTIONS	PRINT EXAMPLE
1	M.D.H.Min	JAN 31 AM 10:00
2	D.M.H.Min	31 JAN AM 10:00
3	M.D.Y.H.Min	JAN 31 '08 AM 10:00
4	D.M.Y.H.Min	31 JAN '08 AM 10:00
5	Y.M.D.H.Min	'08 JAN 31 AM 10:00
6	Y.M.D.H.Min.S	'08 JAN 31 AM 10:00:00
7	D.H.Min	31 AM 10:00
8	DOW.D.H.Min	TH, 31 AM 10:00
9	Y.M.D	'08 JAN 31
10	M.D	JAN 31
11	DOW.D.M.Y	TH, 31 JAN '08
12	C.M.D.Y	SENT JAN 31 '08
13	C.D.M.Y	SENT 31 JAN '08
14	C.Y.M.D	SENT '08 JAN 31
15	M.D.Y.C	JAN 31 '08 SENT
16	D.M.Y.C	31 JAN '08 SENT
17	Y.M.D.C	'08 JAN 31 SENT
18	C.D.H.Min	SENT 31 AM 10:00
19	N.M.D.Y	000123 JAN 31 '08
20	N.D.M.Y	000123 31 JAN '08
21	N.Y.M.D	000123 '08 JAN 31
22	M.D.Y.N	JAN 31 '08 000123
23	D.M.Y.N	31 JAN '08 000123
24	Y.M.D.N	'08 JAN 31 000123
25	N.D.H.Min	000123 31 AM 10:00
26	N.M.D.H.Min	123 JAN 31 AM 10:00
27	N.Y.M.D.H.Min	123 '08 JAN 31 AM 10:00
28	N.Y.M.D.H.Min.S	123 '08 JAN 31 AM 10:00:00
29	N	
30	Customized Comments	

Print Pattern

If you have selected the unit to print the year, this allows you to choose the number of digits in the year (two or four). You may also select the minute format: standard minutes, hundredths, twentieths of tenths of an hour. You may also choose whether to print Leading Zeros.

Example: Change the Year imprint to 4 digits and the Minutes to 1/100 min. and enable Leading Zeros.

1. Press **SELECT** until the ▲ is under the "PRINT PATTERN" mark.
2. The flashing digit indicates "Year Digit Options".

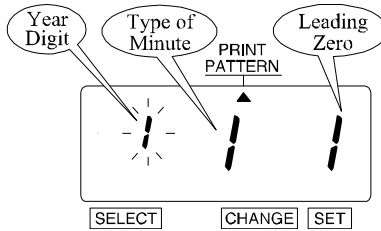

Change Year Digit

1. In this example, press **CHANGE** until the option is "2" (4 Digits). Refer to Year Digit Options below.
2. Press **SET**.
3. The flashing changes from "Year Digit Options" to "Type of Minute".

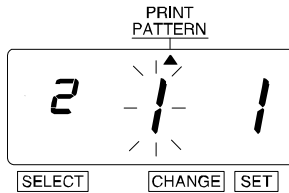

Year Digit Options

OPTION	YEAR DIGIT OPTIONS	PRINT EXAMPLE
1	2 Digits	JAN 31 '08 AM 10:00
2	4 Digits	JAN 31 2008 AM 10:00

Change Type of Minute

1. In this example, press **CHANGE** until the option is "2" (1/100 Min). Refer to Type of Minute Options below.
2. Press **SET**.

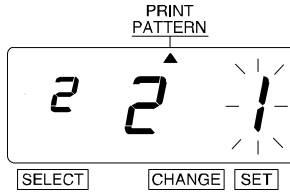

Type of Minute Options

OPTION	TYPE OF MINUTE	PRINT EXAMPLE
1	1/60 Min	JAN 31 2008 AM 10:10
2	1/100 Min	JAN 31 2008 AM 10.17
3	1/20 Min (= 5/100 Min)	JAN 31 2008 AM 10.15
4	1/10 Min	JAN 31 2008 AM 10.1

Change Leading Zero

1. The flashing changes from "Type of Minute" to "Leading Zero".
2. In this example, press **CHANGE** until the option is "2" (Leading Zero Option enabled). Refer to Leading Zero Options below.
3. Press **SET**.

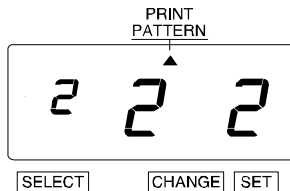

Leading Zero Options

OPTION	LEADING ZERO	PRINT EXAMPLE
1	Zero Disabled	JAN 1 PM 3:00
2	Zero Enabled	JAN 01 PM 03:00

Preset Comments



Prior to enabling Preset Comments, refer to [Print Order Options](#) on page 14 to ensure that you have set up the print order options to allow Preset Comments (options 12 through 18 allow Preset Comments).

Example: Change the comment to "SENT".

1. Press **SELECT** until the ▲ is under the "COMMENT" mark.
2. The flashing digit indicates "Comment Options".

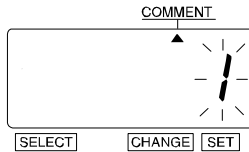

Change Comment Options

1. In this example, press **CHANGE** until the option is "2" (SENT). Refer to [Preset Comment Options](#) below.
2. Press **SET**.

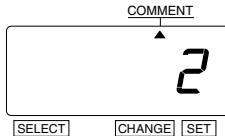

Preset Comment Options

OPTION	COMMENT OPTIONS	PRINT EXAMPLE
1	RCVD (Received)	JAN 31 '08 RCVD
2	SENT	JAN 31 '08 SENT
3	IN	JAN 31 '08 IN
4	OUT	JAN 31 '08 OUT
5	CFMD (Confirmed)	JAN 31 '08 CFMD
6	FILED	JAN 31 '08 FILED
7	PAID	JAN 31 '08 PAID
8	USED	JAN 31 '08 USED
9	FAXED	JAN 31 '08 FAXED
10	VOID	JAN 31 '08 VOID
11	ORIGN (Original)	JAN 31 '08 ORIGN
12	APR'D (Approved)	JAN 31 '08 APR'D
13	CMPL'D (Completed)	JAN 31 '08 CMPL'D

Language

This setting is available if you select "Month", "Day of the Week", or "Comment" in previous "PRINT ORDER".

Example: Change the print language to Spanish.

1. Press **SELECT** until the ▲ is under the "LANGUAGE" mark.
2. The flashing digit indicates "Print Language Options".

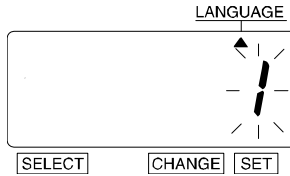

3. In this example, press **CHANGE** until the option is "2" (Spanish). Refer to Language Options below.
4. Press **SET**.

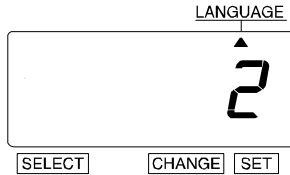

Language Options

OPTION	PRINT LANGUAGE OPTIONS	PRINT EXAMPLE
1	ENGLISH	TH 25 DEC '08 OUT 31 10:00
2	SPANISH	JU, 25 DIC '08 SAL 31 10:00
3	GERMAN	DO, 25 DEZ '08 AUSG 31 10:00
4	FRENCH	JE, 25 DEC '08 SORT 31 10:00
5	ITALIAN	GI, 25 DIC '08 USC 31 10:00
6	PORTUGUESE	QI, 25 DEZ '08 SAIDA 31 10:00
7	NUMERIC	4, 25-12 '08 OUT 31 10:00

Print Method

Change Print Length

1. Press **SELECT** until the ▲ is under the "PRINT METHOD" mark.
2. The flashing digit indicates "Print Length Options".

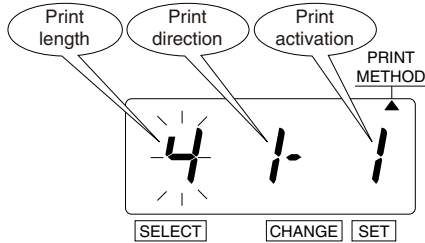

The print length default is 4. You may select from six (1-6) font sizes (refer to Print Length Examples (1-6) below).

1	JAN 11 PM4:13	4	JAN 11 PM4:13
2	JAN 11 PM4:14	5	JAN 11 PM4:13
3	JAN 11 PM4:14	6	JAN 11 PM4:12

Print Length Examples (1-6)



If the font size is too large to print, the font will revert to a smaller size before printing correctly.

3. In this example, press **CHANGE** until the option is "2".
4. Press **SET**.
5. The flashing digit changes from "Print Length" to "Print Direction".

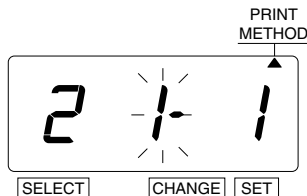

Change Print Direction

Example: Change the print direction to "Left" and the print method to "Manual".

1. In this example, press **CHANGE** until option is "2" (Left-Hand Margin Form). Refer to Print Direction Options below.
2. Press **SET**.

Print Direction Options

OPTION	PRINT DIRECTION OPTIONS
1	Right-Hand Margin Form
2	Left-Hand Margin Form

3. The flashing digit changes from "Print Direction" to "Print Activation".

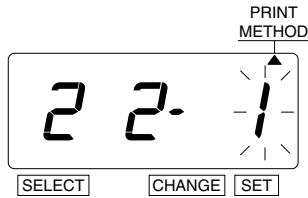

Change Print Activation

1. In this example, press **CHANGE** until the option is "3" (Manual). Refer to Print Method Options below.
2. Press **SET**.

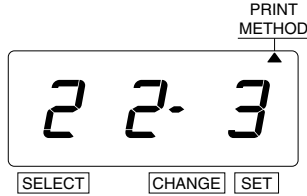

Print Method Options

OPTION	PRINT METHOD OPTIONS
1	Automatic – Allows you to print by inserting a card or piece of paper.
2	Semi-Automatic – Allows you to print by pressing the push bar only when a card or piece of paper is inserted (prints only if the card or form reaches the sensor). Refer to Press Push Bar below.
3	Manual - Allows you to print by pressing the push bar (even if the card or paper does not reach the sensor). Refer to Press Push Bar below.
4	Combination – Allows you to print by pressing the push bar or inserting a card or piece of paper. Refer to Press Push Bar below.

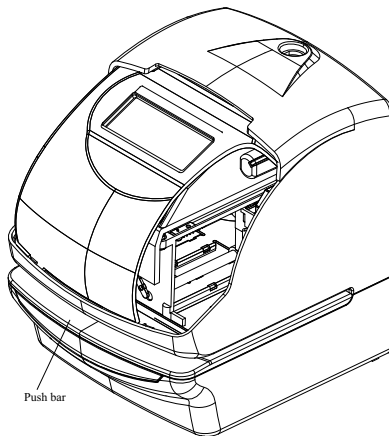

Press Push Bar

Daylight Saving Time (DST)

DST begins on the second Sunday in March and ends on the first Sunday in November. Refer to DST below.

At 2:00 AM on the first day of DST, the clock automatically gains one hour to show 3:00 AM.

At 2:00 AM on the last day of DST, the clock automatically loses one hour to show 1:00 AM.



Not all places in the US observe DST.

DST

YEAR	DST BEGINS 2 AM (2ND SUNDAY IN MARCH)	DST ENDS 2 AM (1ST SUNDAY IN NOVEMBER)
2008	3/9	11/2
2009	3/8	11/1
2010	3/14	11/7
2011	3/13	11/6
2012	3/11	11/4
2013	3/10	11/3
2014	3/9	11/2
2015	3/8	11/1



DST Mode may be set to one of the following options:

OPTION	DESCRIPTION
1	Automatic – Automatically sets from the atomic signal.
2	Off – DST is off.
3	Manual – The customer manually sets the DST feature (refer to “Manually Setting DST” on page 23).

Manually Setting DST

Example:

Start Date – Sunday, March 9, 2008

End Date – Sunday, November 2, 2008

In this example, the unit remembers the **Start Date** as the second Sunday in March and the **End Date** as the first Sunday in November. Once the unit is set, it automatically updates the settings every year thereafter. No further manual setting is necessary.

1. Press **SELECT** until the ► is beside the "DAYLIGHT SAVING TIME" mark.

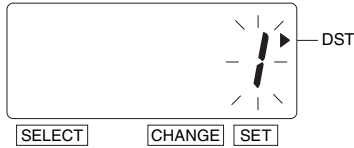

2. Press **CHANGE** until the option is "3" (Manual).
3. Press **SET**.
4. The flashing digit indicates "Year".

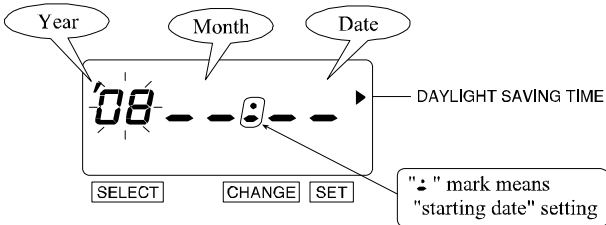

Start Date

Change the Year

1. In this example, the "Year" is not being changed. Refer to DST on page 22.
2. Press **SET**.

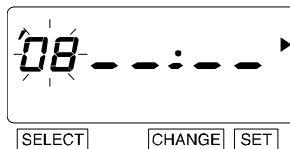

3. The flashing changes from "Year" to "Month".

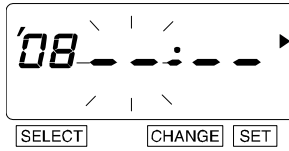

Change the Month

1. In this example, press **CHANGE** until the month is "3" (March). Refer to DST on page 22.
2. Press **SET**.

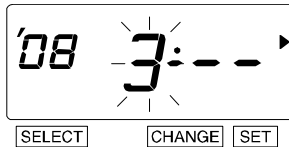

3. The flashing changes from "Month" to "Date".

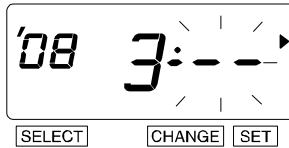

Change the Date

1. In this example, press **CHANGE** until the date is "09". Refer to DST on page 22.
2. Press **SET**.
3. The "Starting Date" of the display changes from flashing to steady and the ▲ mark is displayed under "SU".

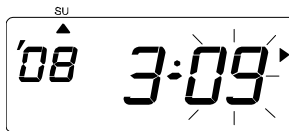

End Date

Change the Year

1. In this example, the "Year" is not being changed. Refer to DST on page 22.
2. Press **SET**.

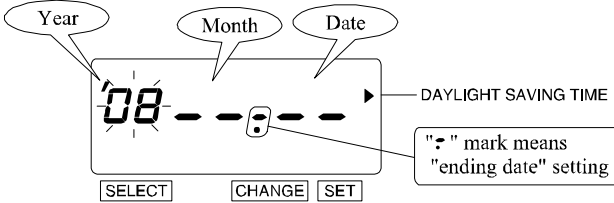

3. The flashing changes from "Year" to "Month".

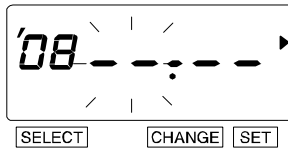

Change the Month

1. In this example, press **CHANGE** until the month is "11" (November). Refer to DST on page 22.
2. Press **SET**.

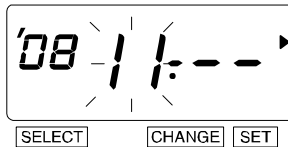

3. The flashing changes from "Month" to "Date".

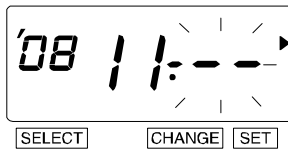

Change the Date

1. In this example, press **CHANGE** until the date is "02". Refer to DST on page 22.
2. Press **SET**.
3. The "Ending Date" of the display changes from flashing to steady and the ▲ mark is displayed under "SU".



Numbering Print



Prior to enabling Numbering Print, refer to [Print Order Options](#) on page 14 to ensure that you have set up the print order options to allow Numbering Print (options 19 through 29 allow Numbering Print).

In this setup, you can select digits of:

- Printed Number
- Repeat Times of Number
- Type of Number Reset

Example: Change the Number Digit to 4 digits, the Repeat Times to 2, and the Reset to 0.

1. Press **SELECT** until the ► is beside the "NUMBER" mark.
2. The flashing digit indicates "Number Digit".

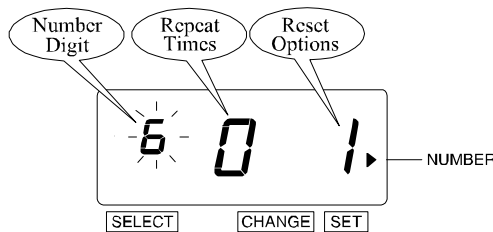

Print Example: 6 Digits of Number → 123456 JAN 31 '08
4 Digits of Number → 1234 JAN 31 '08

Change Number of Digits



The Number of Digits can be set from 1 to 8.

1. In this example, press **CHANGE** until the number digit is "4".
2. Press **SET**.
3. The flashing digit changes from "Number Digit" to "Repeat Times".

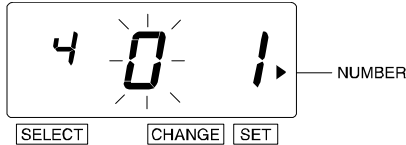

Change Repeat Times



The Repeat Times can be set from 0 to 9. The "0" means no advancing of numbers.



If the recorder is set to repeat 0 times, the number will not advance.

1. In this example, press **CHANGE** until the option is "2".
2. Press **SET**.

Print Example: 0 time repeat → (1st time) 123456 JAN 31 '08
(2nd time) 123456 JAN 31 '08
(3rd time) 123456 JAN 31 '08
(4th time) 123456 JAN 31 '08
(5th time) 123456 JAN 31 '08
⋮ ⋮

2 times repeat → (1st time) 123456 JAN 31 '08
(2nd time) 123456 JAN 31 '08
(3rd time) 123457 JAN 31 '08
(4th time) 123457 JAN 31 '08
(5th time) 123458 JAN 31 '08
⋮ ⋮

3. The flashing digit changes from "Repeat Times" to "Reset Options".

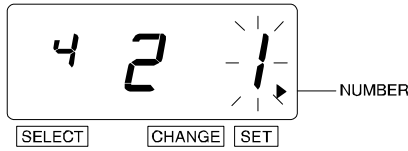

Change Reset Options



The Reset Option can be set from 1 to 3. Refer to Reset Options below.

1. In this example, press **CHANGE** until the option is "3".
2. Press **SET**.

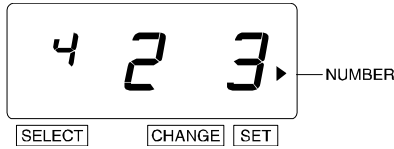

Reset Options

OPTION	DESCRIPTION	RESET OCCURS
1	Disabled	N/A
2	Return to INITIAL NUMBER	Change of Date (change at midnight)
3	Return to 0	Change of Date (change at midnight)

Initial Number

Example: Set the Initial Number to "123". Refer to "Numbering Print" on page 26.

1. Press **SELECT** until the ► is beside the "INITIAL NUMBER" mark.
2. The flashing digit "-" indicates the 1st digit of the initial number.

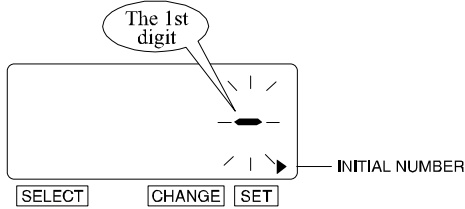

Set Initial Number



Up to 8 digits can be set; however, the number of digits for "Initial Number" depends on the number set. Refer to "Numbering Print" on page 26.

1st Digit

1. In this example, press **CHANGE** until the 1st digit is "1".
2. Press **SET**.

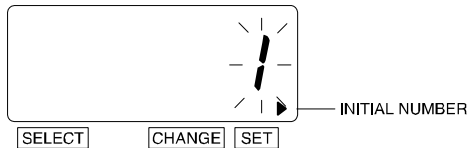

3. The 2nd digit of the "Initial Number" appears next to "1" (1st digit).

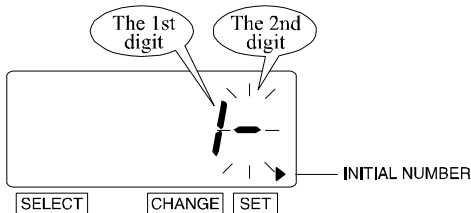

2nd Digit

1. In this example, press **CHANGE** until the 2nd digit is "2".
2. Press **SET**.
3. The 3rd digit of the "Initial Number" appears next to "2" (2nd digit).

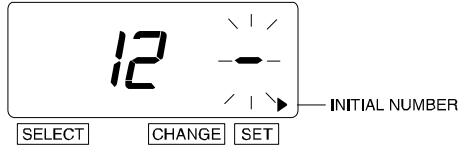

3rd Digit

1. In this example, press **CHANGE** until the 3rd digit is "3".
2. Press **SET**.

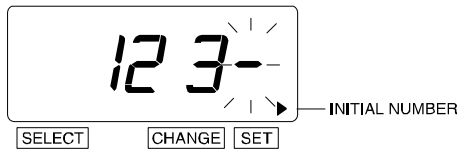

Set Password

Once the password is set, you must enter it before changing any settings. Refer to “Enter Password” on page 32.



You may choose any 4-digit number from 0001 to 9998. Numbers "0000" and "9999" are not valid passwords.

All settings must be reset if you forget the password. Refer to “Reset Factory Default Settings” on page 59.

Example: Set the Password to "1234".

1. Press **SELECT** until the ▼ is above the "PASSWORD" mark.
2. The first two digits flash.

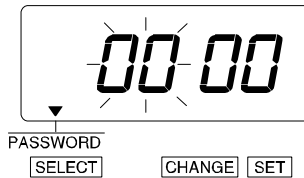

Change the First Two Digits

1. In this example, press **CHANGE** until the first two digits are "12".
2. Press **SET**.
3. The flashing changes to the last two digits.

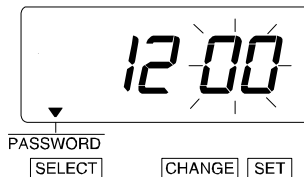

Change the Last Two Digits

1. In this example, press **CHANGE** until the last two digits are "34".
2. Press **SET**.

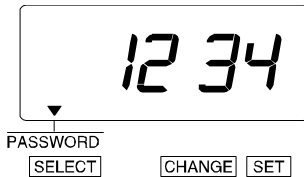

Enter Password



Once the password is set, you must enter the current password before changing any settings.

1. Press **SELECT**.
2. The numbers "9999" are displayed and the first two digits flash.

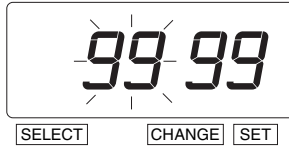

Set the First Two Digits

1. In this example, press **CHANGE** until the first two digits are "12".
2. Press **SET**.
3. The flashing changes to the last two digits.

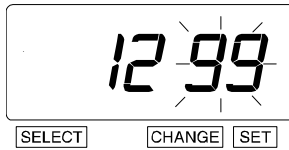

Set the Last Two Digits

1. In this example, press **CHANGE** until the last two digits are "34".
2. Press **SET** twice.

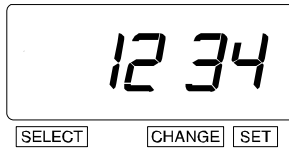

Cancel the Password



The code "0000" must be entered to cancel password activation.

Customized Comments



There is a maximum of 3 lines of comment that can be set to print.



This unit can print a maximum of 31 characters. However, the number of acceptable characters is dependent on the size of the font used. Refer to “Character Code for Alphanumeric” on pages 64-68.

Example:

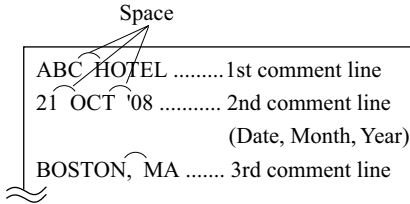

Customized Comments Example

1. Press **SELECT** until the ▲ is under the "PRINT ORDER" mark.
2. The flashing digit indicates "Print Order Options".

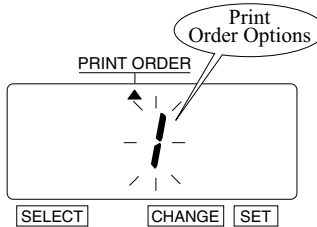

Change Print Order Options

1. In this example, press **CHANGE** until the option is "30" (Customized Comments).
Refer to Print Order Options on page 14.
2. "Print Position" appears next to the flashing digit "Print Order".

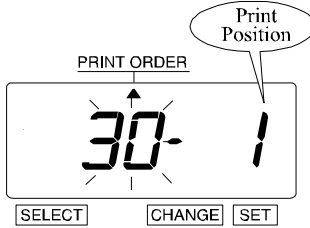

Change Print Position Options

(Only available when using Custom Comments.)

1. Press **SET**.
2. The flashing digit changes from "Print Order" to "Print Position".

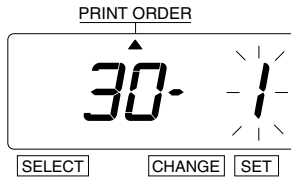

3. In this example, press **CHANGE** until option is "2" (Center).
4. Press **SET**.

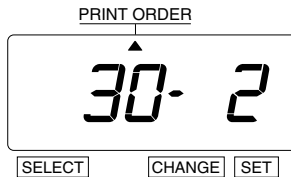

Print Position Options

OPTION	COMMENT OPTIONS
1	ALIGN LEFT
2	CENTER
3	ALIGN RIGHT

Align Left

ABC HOTEL
21 OCT '08
BOSTON, MA

Center

ABC HOTEL
21 OCT '08
BOSTON, MA

Align Right

ABC HOTEL
21 OCT '08
BOSTON, MA

Setting the 1st Command Line

1. Press **SELECT** until the ▲ is under the "COMMENT" mark.
2. The flashing digit indicates "Character Position".
3. Press **SET**.

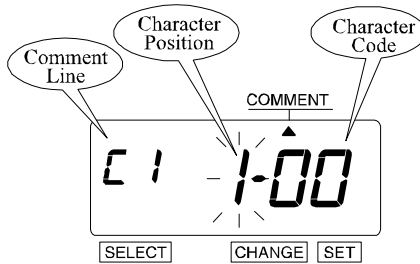

Set 1st Character Code

1. The flashing digit changes from "Character Position" to "Character Code".

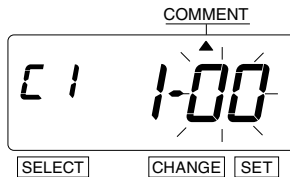

2. In this example, the 1st character is "A". Press **CHANGE** until the Character Code is "02" (A). Refer to "Character Code for Alphanumeric" on pages 64-68.
3. Press **SET**.

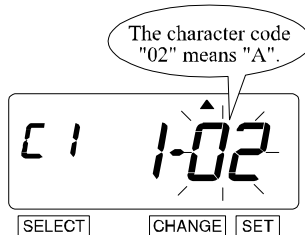

Set 2nd Character Code

1. The "Character Position" changes from the 1st character to the 2nd character.
2. Press **SET**.

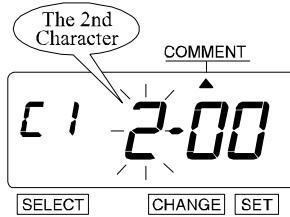

3. The "Character Position" changes to the "Character Code".
4. In this example, the 2nd character is "B". Press **CHANGE** until the Character Code is "03" (B). Refer to "Character Code for Alphanumeric" on pages 64-68.
5. Press **SET**.

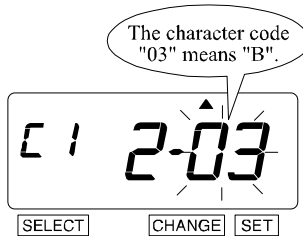

Set 3rd Character Code

1. The "Character Position" changes from the 2nd character to the 3rd character.
2. Press **SET**.
3. The "Character Position" changes to the "Character Code".

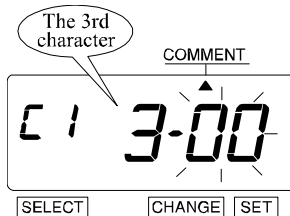

4. In this example, the 3rd character is "C". Press **CHANGE** until the Character Code is "04" (C). Refer to "Character Code for Alphanumeric" on pages 64-68.

5. Press **SET**.

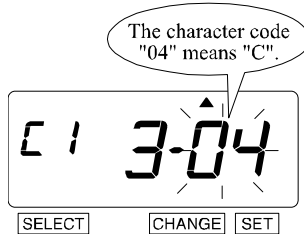

Follow the same procedures as outlined above for setting further Character Codes.

Setting the 2nd Command Line

1. Press **SET** twice to change the comment line number to "C2".
2. The flashing digit indicates "Character Position".

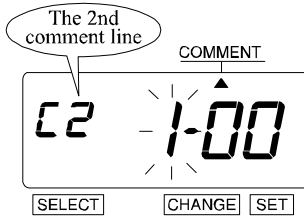

3. Press **SET**.
4. The "Character Position" changes to the "Character Code".

Set 1st Character Code

1. In this example, the 1st character is "DATE". Press **CHANGE** until the Character Code is "28" (DATE). Refer to "Character Code for Alphanumeric" on pages 64-68.
2. Press **SET**.

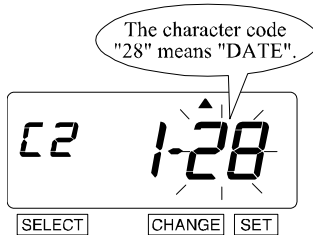

3. The "Character Code" changes to the "Character Position".
4. Press **SET**.
5. The "Character Position" changes to the "Character Code".

Set 2nd Character Code

1. In this example, the 2nd character is "SPACE". Press **CHANGE** until the Character Code is "01" (SPACE). Refer to "Character Code for Alphanumeric" on pages 64-68.
2. Press **SET**.

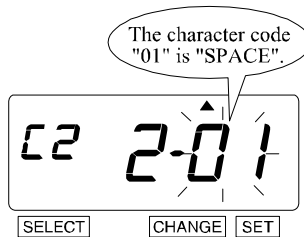

3. The "Character Code" changes to the "Character Position".
4. Press **SET**.
5. The "Character Position" changes to the "Character Code".

Set 3rd Character Code

1. In this example, the 3rd character is "MONTH". Press **CHANGE** until the Character Code is "27" (MONTH). Refer to "Character Code for Alphanumeric" on pages 64-68.
2. Press **SET**.

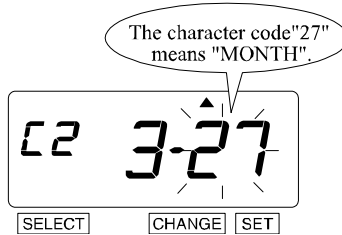

Follow the same procedures as outlined above for setting further Character Codes.

Setting the 3rd Command Line

1. Press **SET** twice to change the comment line number to "C3".

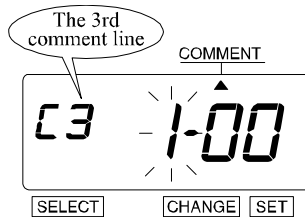

2. The flashing digit indicates "Character Position".
3. Press **SET**.
4. The "Character Position" changes to the "Character Code".

Set 1st Character Code

1. In this example, the 1st character is "B". Press **CHANGE** until the Character Code is "03" (B). Refer to "Character Code for Alphanumeric" on pages 64-68.
2. Press **SET**.

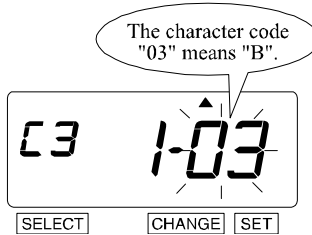

3. The "Character Code" changes to "Character Position".
4. Press **SET**.
5. The "Character Position" changes to the "Character Code".

Set 2nd Character Code

1. In this example, the 2nd character is "O". Press **CHANGE** until the Character Code "10" (O). Refer to "Character Code for Alphanumeric" on pages 64-68.
2. Press **SET**.

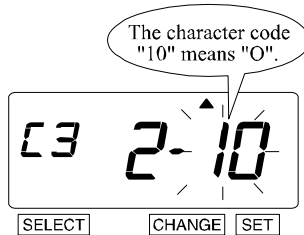

3. The "Character Code" changes to "Character Position".
4. Press **SET**.
5. The "Character Position" changes to the "Character Code".

Set 3rd Character Code

1. In this example, the 3rd character is "A". Press **CHANGE** until the Character Code is "02" (A). Refer to "Character Code for Alphanumeric" on pages 64-68.
2. Press **SET**.

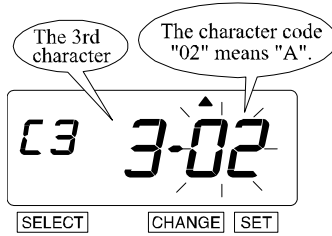

Follow the same procedures as outlined above for setting further Character Codes.

Refer to the Change Customized Comments below to make changes to your customized comments.

Change Customized Comments

CODE	MEANING
F8	Insert Character
F9	Delete Character
FA	Insert Line
Fb	Delete Line
FC	Exchange Line 1 to 2
Fd	Exchange Line 2 to 3
FE	Exchange Line 1 to 3
FF	Delete All

Confirming/Changing Customized Comments

Example 1: Confirming 1st Comment Line: No change

Example 2: Changing Customized Comment Line: Change from "YEAR" to time "HH:MM"

Example 3: Confirming 3rd Comment Line: No change

Refer to Confirming/Changing Customized Comments Examples below.

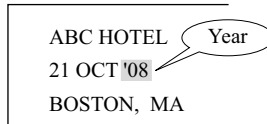

ABC HOTEL Year
21 OCT '08
BOSTON, MA

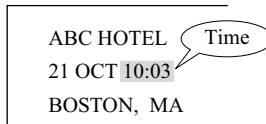

ABC HOTEL Time
21 OCT 10:03
BOSTON, MA

Confirming/Changing Customized Comments Examples

1. Press **SELECT** until the ▲ is under the "COMMENT" mark.

Confirming 1st Comment Line

1. The flashing digit indicates "Character Position".

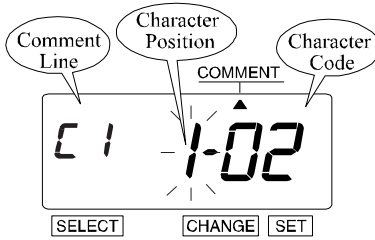

2. In this example, press **CHANGE**. While the "Character Position" changes, the "Character Code" that has been set appears. Refer to "Character Code for Alphanumeric" on pages 64-68.

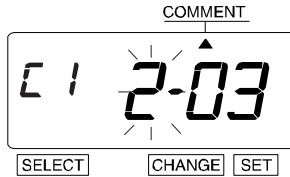

3. Press **CHANGE**. Confirm the last character code of the 1st Comment Line.

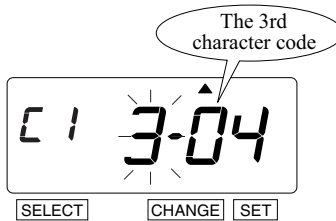

Confirming 2nd Comment Line

1. Press **SET** 4 times. The 2nd Comment Line displays.

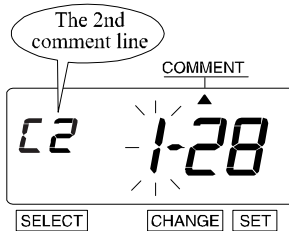

Confirm the 2nd Comment Line in the same way that you confirmed the 1st Comment Line.

Confirming 3rd Comment Line



Confirm the 3rd Comment Line in the same way that you confirmed the 1st Comment Line.

Changing the Customized Comments

- In this example, press **CHANGE** until the option is "5" (Year). Refer to Comment Lines below.
- Press **SET**.
- The "Character Position" changes to the "Character Code".

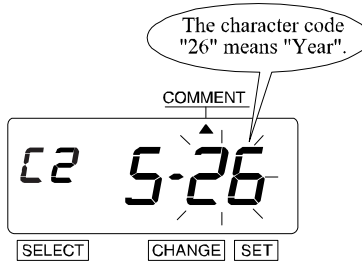

Comment Lines

CHARACTER POSITION	1	2	3	4	5
CODE	28	01	27	01	26
MEANING	Date	SPACE	Month	SPACE	Year

4. In this example, press **CHANGE** until the option is "2A" (HH:MM). Refer to Comment Lines below.
5. Press **SET**.

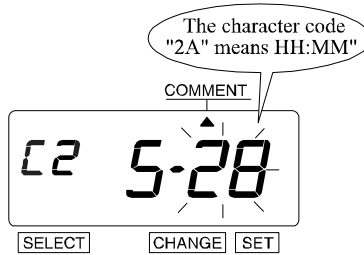

Comment Lines

CHARACTER POSITION	1	2	3	4	5
CODE	28	01	27	01	2A
MEANING	Date	SPACE	Month	SPACE	HH:MM

Time Table Program Features

The time table function allows I-Mark™ "*" printing (Irregular registration Mark), an External Time Signal and a Built-in Buzzer. These functions can be programmed for each day of the week and each time period. Use the I-Mark™ "*" (asterick prints) to indicate punches earlier or later than scheduled. The "External Signal" and the "Built-in Buzzer" are available only when "Optional Board" is connected to the unit.

I-Mark™

I-Mark™ was created to help identify irregular punches outside of a set schedule.

Example 1: The time table program is explained in Time Table Example 1 and Time Table Based on Example 1 below.

	0:00	9:00	17:30	0:00
Monday to Saturday	I-Mark™ "*" " OFF	I-Mark™ "*" " ON	I-Mark™ "*" " OFF	

Time Table Example 1

Time Table Based on Example 1

PROGRAM NO.	DAY OF THE WEEK	TIME	I-MARK™ "*" "
01	Mon. – Sat.	9:00	ON
02	Mon. – Sat.	17:30	OFF

Other Notes on I-Mark™:

- I-Mark™ "*" is not printed for the time period with no program setting.
- Up to 48 programs can be set (Program No. 1 through Program No. 48).
- Once the I-Mark™ "*" is programmed, you must set program off.

Print example: JAN 31 8:30
 JAN 31 10:00 (*) ← I-Mark™

External Time Signal/Built-in Buzzer

This optional feature identifies work start and stop times.



External Time Signal and Built-in Buzzer should be controlled by the Time Table Program and its duration settings.

For these features to be functional, the optional board must be installed in the unit.

Connection Specifications for External Time Signal Contact:

- Contact Output: Dry Contact
- Contact Capacity: 5A, 30 VDC (Resistive)

Example 2: The time table program is explained in Time Table Example 2 and Time Table Based on the Example 2 below.

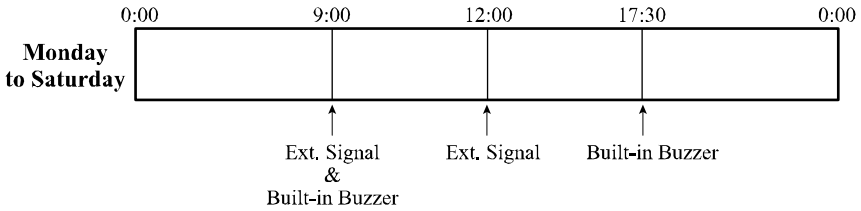

Time Table Example 2

Time Table Based on the Example 2

PROGRAM NO.	DAY OF THE WEEK	TIME	EXT. SIGNAL ON	BUILT-IN BUZZER ON
01	Mon. – Sat.	9:00	✓	
02	Mon. – Sat.	9:00		✓
03	Mon. – Sat.	12:00		✓
04	Mon. – Sat.	17:30	✓	

- Up to 48 programs can be set (Program No. 1 through Program No. 48).

Time Table Program Setup

1. Press **SELECT** until the ▼ is above the "TIME TABLE PROGRAM" mark.
2. The flashing digit indicates "Program No".

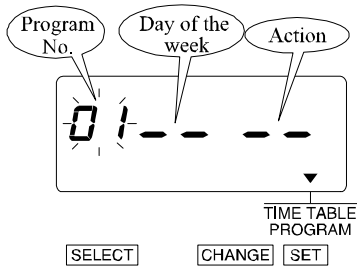

Set Example 2, Program No. 1

Set Day of the Week

1. Press **SET**.
2. The flashing changes from the "Program No." to "Day of the Week". Refer to Set Day of the Week below.
3. In this example, press **CHANGE** until the option is "9" (Monday to Saturday).
4. Press **SET**.

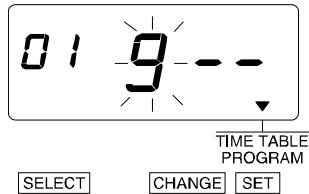

Set Day of the Week

OPTION	DAY OF THE WEEK	OPTION	DAY OF THE WEEK
1	Monday only	6	Saturday only
2	Tuesday only	7	Sunday only
3	Wednesday only	8	Monday to Friday
4	Thursday only	9	Monday to Saturday
5	Friday only	10	Every day

5. The flashing changes from the "Day of the Week" to "Action".

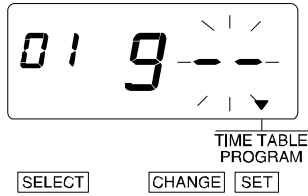

Set Action

1. Press **CHANGE** until the option is "3" (External Signal ON). Refer to Set Action below.
2. Press **SET**.

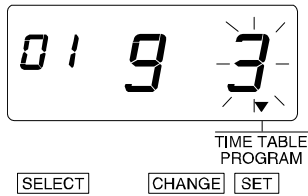

Set Action

OPTION	ACTION
1	I-Mark™ "*" ON
2	I-Mark™ "*" OFF
3	Ext. Signal ON
4	Built-in Buzzer ON

3. The display changes to the following figure.

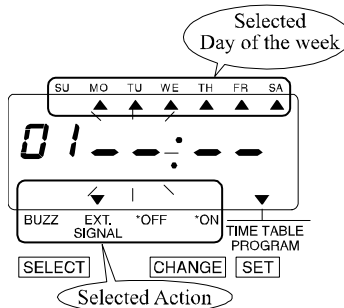

Set Hour

1. In this example, press **CHANGE** until the hour is "9".
2. Press **SET**.

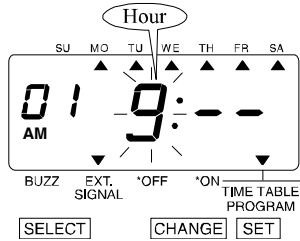

3. The flashing changes from "Hour" to "Minute".

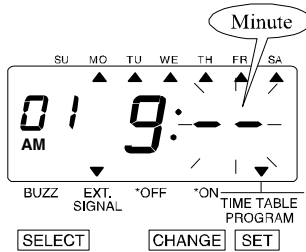

Set Minute

1. Press **CHANGE** until the minute is "00".
2. Press **SET**.

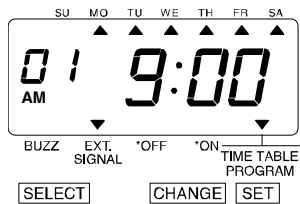

Set Example 2, Program No. 2

1. Press **CHANGE** twice, then press **SET**.
2. The display changes to the following figure.

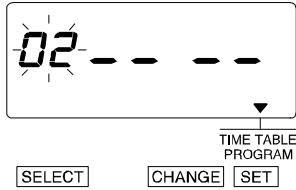

3. Set Action. Refer to “Set Action” on page 49 as identified in Program 1.
4. Press **SET**.
5. Set Hour and Minutes. Refer to “Set Hour” on page 50 and “Set Minute” on page 50 as identified in Program 1.
6. Press **SET**.

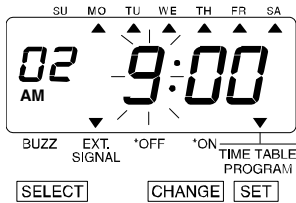

Make settings for any additional programming in the same manner as you did for Program No. 1 and Program No. 2.

Up to 48 programs can be set (Program No. 1 through Program No. 48).

Confirm Time Table Program Settings

1. Press **SELECT** until the ▼ is above the "TIME TABLE PROGRAM" mark.
2. The flashing digit indicates "Program No".
3. Press **CHANGE**.
4. After you confirm the program settings, press **SET** (6 times).

Delete Time Table Program Settings

Example: Delete the "Program No. 2".

1. Press **SELECT** until the ▼ is above the "TIME TABLE PROGRAM" mark.
2. The flashing digit indicates "Program No".

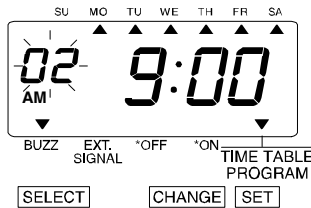

3. Press **CHANGE** until the desired Program No. is displayed.
4. Press **SET**.
5. The flashing changes to the following figure.

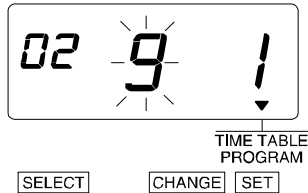

Delete Program No. 2

1. Press **CHANGE** until the option is "--".
2. Press **SET**.

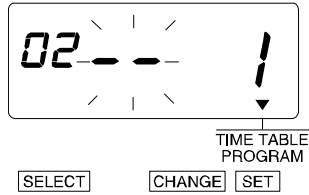

3. The display changes to the following figure.

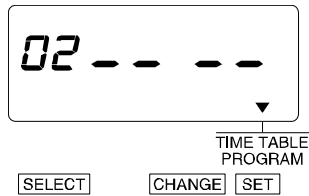

With the optional board installed, the durations of External Time Signal and Built-in Buzzer can be set from 1 to 30 seconds.

Example: Change the External Time Signal to 30 seconds and the Built-in Buzzer to 10 seconds.

1. Press **SELECT** until the ▼ is above the "EXT. SIGNAL/BUILT-IN BUZZ" mark.
2. The flashing digit indicates "Ext. Signal".

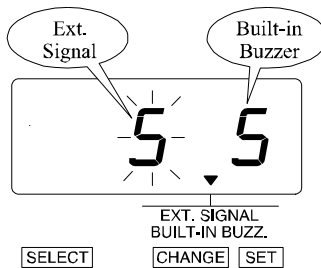

Change External Signal

1. In the example, press **CHANGE** until the option is "30".
2. Press **SET**.

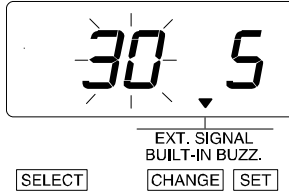

3. The flashing changes from "Ext. Signal" to "Built-in Buzzer".

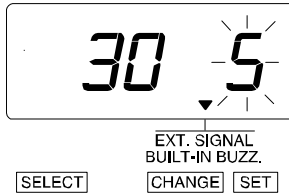

Change Built-in Buzzer

1. Press **CHANGE** until the option is "10".
2. Press **SET**.

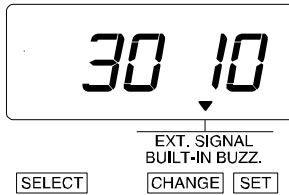

OPTIONAL INSTALLATION/CONNECTIONS

Connecting the External Time Signal

If external signal(s) are required, the addition of a relay and signal control board (not supplied) will be necessary.

Please consult your local electrician.

When a signal is activated, the internal contacts close completing the circuit. These internal contacts are "dry" and supply no voltage. Voltage applied to these contacts must **not** exceed 30 volts. An external relay must be used to activate signaling devices.

Recommended Relay and Signal Control Board

Acroprint Relay	P/N: 01-0230-000
Acroprint Signal Control Board	P/N: 10-0164-000

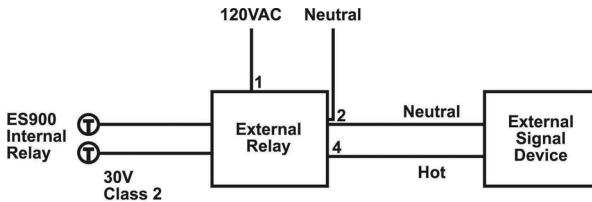

Connections

CAUTION

Be sure to unplug the unit from the wall outlet before connecting wires of the External Time Signal. Improper connection may cause a malfunction of the unit. Also refer to "Attaching the Wire Clamp" on page 57 to secure wires with the wire clamp.

1. Open the unit. Refer to "Open Unit" on page 3.
2. Insert wires into two right terminals for external time signal and tighten both screws. Refer to Insert Wires into Right Terminals below.

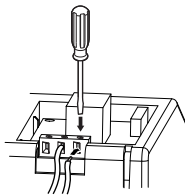

Insert Wires into Right Terminals

Installing the Ni-Cd Battery

This option allows for printing up to 200 registrations without AC power.

Optional Battery Pack – Order Acroprint Part Number 58-0108-000

1. Open the unit. Refer to **Open Unit** on page 3.
2. Remove the battery door screw and battery door.
3. Route the battery wires through the hole over the battery compartment.
4. Plug the battery connector into the 3-prong connector.
5. Place the battery on top of the battery door.
6. Reinstall the battery door and battery door screw.
7. Close the unit. Refer to **“Close Unit”** on page 4.

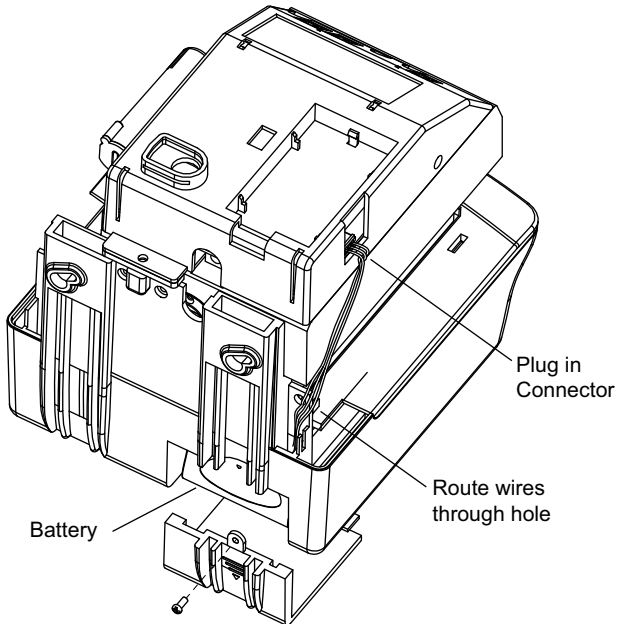

Install Battery

Attaching the Wire Clamp

CAUTION *Be sure to unplug the unit from the wall outlet before attaching the wire clamp.*

1. Remove two screws holding the wire clamp. Refer to [Remove Screws Holding Wire Clamp](#) below.

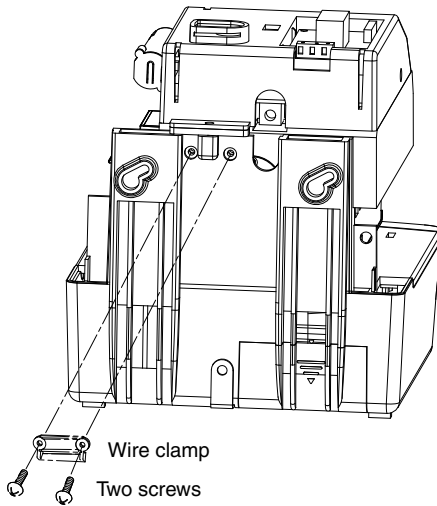

Remove Screws Holding Wire Clamp

2. Route the wires through the hole of the wire clamp and secure them with screws. Refer to [Route Wires Through Wire Clamp](#) below.

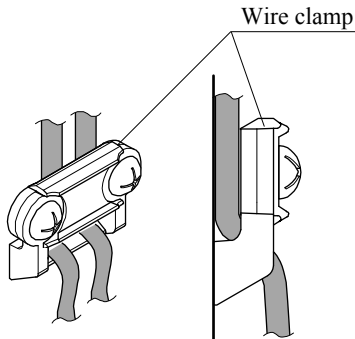

Route Wires Through Wire Clamp

-
-
3. Alternate Method - If diameter of wires is too small to fix by the above method, turn the wire clamp upside down and feed wires through the clamp. Then secure them with screws. Refer to Alternate Method to Route Wires Through Wire Clamp below.

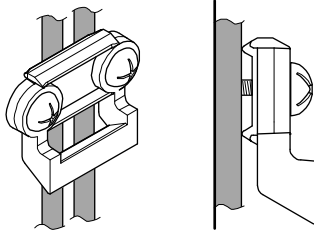

Alternate Method to Route Wires Through Wire Clamp

4. Close the unit. Refer to “Close Unit” on page 4.

RESET FACTORY DEFAULT SETTINGS

Press the reset switch with a pointed object to return all settings to the factory default settings. Refer to Press Reset Button below. Refer to Factory Default Settings on page 60.

IMPORTANT



All custom settings will be deleted and will revert to the factory default settings when the reset switch is pressed.

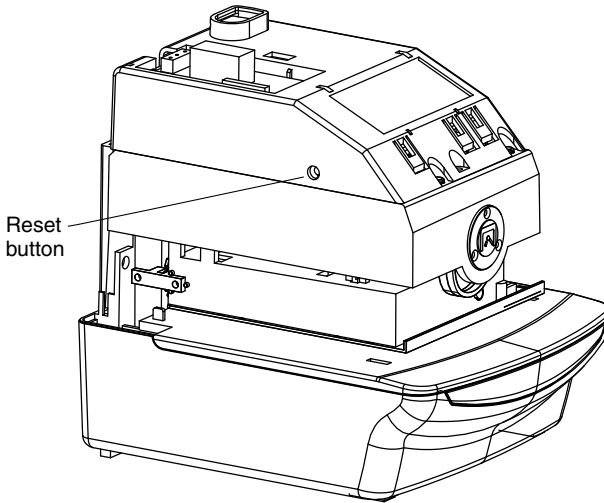

Press Reset Button

Factory Default Settings

FEATURE	FACTORY DEFAULT SETTINGS
Time	Default = 8:00 AM
Date	Default = 01/01/2008
12/24 Hour Format	Default = 1 (12 hours format, AM/PM)
Print Order	Default = 1 (M.D.H.Min)
Print Pattern	Year Digit Default = 1 (2 digits) Minutes Default = 1 (60 minutes format) Leading Zero Default = 1 (zero disabled)
Pre-Programmed Comments	Default = 1 (RCVD)
Language	Default = 1 (English)
Print Method	Print Length Default = 4 Print Direction Default = 1 (right-hand margin form) Print Method Default = 1 (automatic)
Daylight Saving Time	Default = 1 (automatic)
Number (Serial Number Print)	Serial Number Digit Default = 6 digits (range 1-8) Repeat Times Default = 0 (range 0-9) Reset Options Default = 1 (range 1-3)
Initial Number	Default = 000000
Time Zone	-05 Eastern Standard Time
Password	Default = 0000
Ext. Signal	Default = 5 seconds (range 1-30 seconds)
Built-in Buzzer	Default = 5 seconds (range 1-30 seconds)
Slave Clock	Default = 0 (disabled)

WALL MOUNTING

CAUTION *The ES900 should be mounted on 1/2 inch drywall using two ST 4x20 screws and fasteners.*

1. Install the supplied wall-mount screws by using the template. Refer to Install Wall-Mount Screws below.



Be sure to keep about 6mm (1/4") of the screw head away from the wall. The recommended height from the floor to the bottom of the unit is 45".

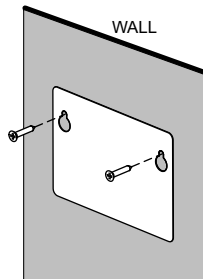

Install Wall-Mount Screws

2. Open the unit. Refer to “Open Unit” on page 3.
3. Hang the unit on the wall and install Wall Mount Brackets. Refer to Hang Unit below.

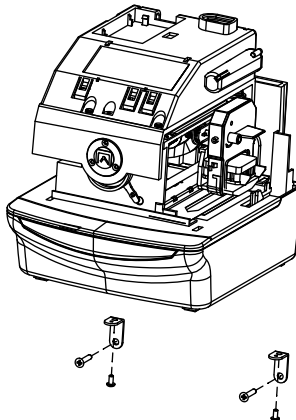

Hang Unit

4. Close the unit. Refer to “Close Unit” on page 4.

REPLACING THE RIBBON CASSETTE

1. Open the unit. Refer to “Open Unit” on page 3.
2. Hold the ribbon cassette by its tab and pull the ribbon cassette straight out to remove it. Refer to Remove Ribbon Cassette below.

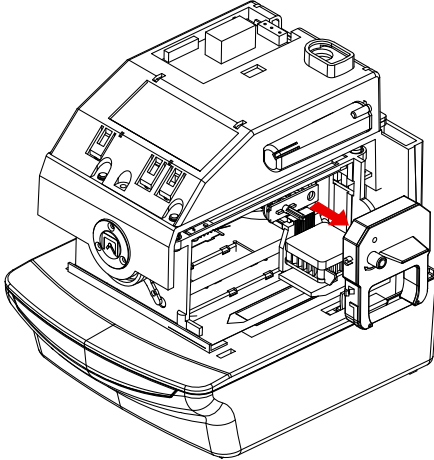

Remove Ribbon Cassette

3. Turn the knob of the new ribbon cassette in the direction of the arrow (clockwise) to tighten the ribbon. Refer to Tighten Ribbon Cassette below.

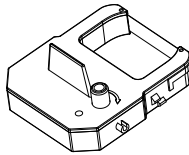

Tighten Ribbon Cassette

4. Install the ribbon cassette inside the unit. Refer to [Install Ribbon Cassette](#) below. Push the ribbon cassette until it snaps into position.



Turning the knob on the ribbon cassette may make installation easier.

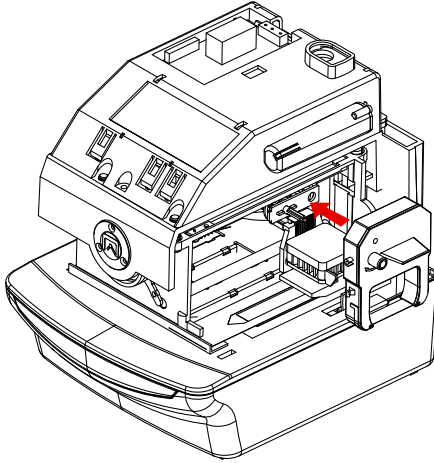

Install Ribbon Cassette



Install the ribbon cassette so that the ribbon is between the print head and the ribbon mask. Printing will not function properly if the ribbon is placed behind the ribbon mask. Refer to [Install Ribbon Cassette Between Print Head and Ribbon Mask](#) below.

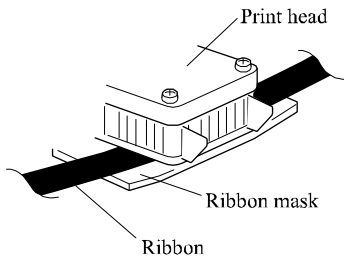

Install Ribbon Cassette Between Print Head and Ribbon Mask

5. Turn the knob of the ribbon cassette in the direction of the arrow to tighten the ribbon.
Refer to Tighten Ribbon Cassette below.

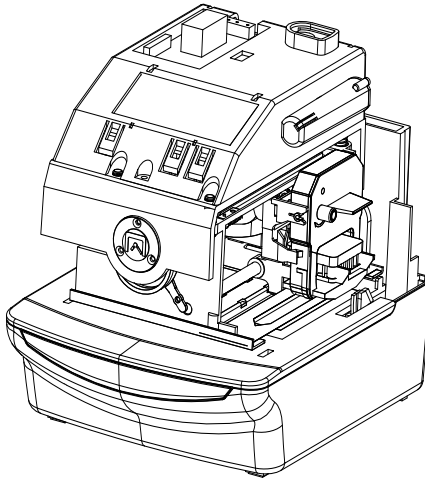

Tighten Ribbon Cassette

6. Close the unit. Refer to “Close Unit” on page 4.

CHARACTER CODE FOR ALPHANUMERIC

Code	Character	Max. Dots
00	NULL	—
01	SPACE	3

Code	Meaning	Code	Meaning
F8	Insert Character	FC	Exchange Line 1 to 2
F9	Delete Character	Fd	Exchange Line 2 to 3
FA	Insert Line	FE	Exchange Line 3 to 1
Fb	Delete Line	FF	Delete All

Legend:

Num: Sequential Number

HH: Hour

MM: Minute

SS: Second

DOW: Day Of the Week

※ 1 ~ ※15: Language-Specific Character

Large (Bold) Character

Code	Character	Max. Dots	Code	Character	Max. Dots	Code	Character	Max. Dots
02	A	8	1b	Z	8	34	※4	-
03	B	8	1c	0	8	35	※5	-
04	C	8	1d	1	8	36	※6	-
05	D	8	1E	2	8	37	※7	-
06	E	8	1F	3	8	38	※8	-
07	F	8	20	4	8	39	※9	-
08	G	8	21	5	8	3A	※10	-
09	H	8	22	6	8	3b	※11	-
0A	I	5	23	7	8	3c	※12	-
0b	J	8	24	8	8	3d	※13	-
0c	K	8	25	9	8	3E	※14	-
0d	L	8	26	Year	32(19)	3F	※15	-
0E	M	8	27	Month	24	40	'	3
0F	N	8	28	Date	16	41	*	7
10	O	8	29	DOW	16	42	+	7
11	P	8	2A	HH:MM	37(49)	43	,	5
12	Q	8	2b	HH:MM:SS	58(70)	44	-	7
13	R	8	2c	Number	8x(n)	45	.	5
14	S	8	2d	Number	8x(n)	46	/	8
15	T	7	2E	Number	8x(n)	47	:	5
16	U	8	2F	Number	8x(n)	48	;	5
17	V	8	30	Number	8x(n)	49	_	6
18	W	8	31	※1	-	4A	&	10
19	X	8	32	※2	-			
1A	Y	7	33	※3	-			

NOTE: () is to indicate the following meanings:

Code = 26: 2 digits setting of YEAR.

Code = 2A and 2b: AM/PM setting of HOUR.

Code = 2C to 30: Number digits depend on the setting.

Large Character

Code	Character	Max. Dots	Code	Character	Max. Dots	Code	Character	Max. Dots
4b	A	7	54	Z	7	7d	※4	-
4c	B	7	55	0	7	7e	※5	-
4d	C	7	56	1	7	7f	※6	-
4e	D	7	57	2	7	80	※7	-
4f	E	7	58	3	7	81	※8	-
50	F	7	59	4	7	82	※9	-
51	G	7	5a	5	7	83	※10	-
52	H	7	5b	6	7	84	※11	-
53	I	4	5c	7	7	85	※12	-
54	J	7	5d	8	7	86	※13	-
55	K	7	5e	9	7	87	※14	-
56	L	7	5f	Year	28(18)	88	※15	-
57	M	8	70	Month	22	89	'	3
58	N	7	71	Date	14	8a	*	6
59	O	7	72	DOW	15	8b	+	6
5a	P	7	73	HH:MM	32(44)	8c	,	4
5b	Q	7	74	HH:MM:SS	50(62)	8d	-	6
5c	R	7	75	Number	7x(n)	8e	.	4
5d	S	7	76	Number	7x(n)	8f	/	6
5e	T	6	77	Number	7x(n)	90	:	4
5f	U	7	78	Number	7x(n)	91	;	4
60	V	7	79	Number	7x(n)	92	_	5
61	W	8	7a	※1	-	93	&	9
62	X	7	7b	※2	-			
63	Y	6	7c	※3	-			

NOTE: () is to indicate the following meanings:

Code = 6F: 2 digits setting of YEAR.

Code = 73 and 74: AM/PM setting of HOUR.

Code = 75 to 79: Number digits depend on the setting.

Small Character

Code	Character	Max. Dots	Code	Character	Max. Dots	Code	Character	Max. Dots
94	A	6	b5	7	6	d6	HH:MM	26(37)
95	B	6	b6	8	6	d7	HH:MM:SS	40(57)
96	C	6	b7	9	6	d8	Number	6x(n)
97	D	6	b8	a	5	d9	Number	6x(n)
98	E	6	b9	b	5	dA	Number	6x(n)
99	F	6	bA	c	5	dB	Number	6x(n)
9A	G	6	bB	d	5	dC	Number	6x(n)
9b	H	6	bC	e	5	dD	※1	-
9C	I	4	bD	f	4	dE	※2	-
9d	J	6	bE	g	5	dF	※3	-
9E	K	6	bF	h	5	E0	※4	-
9F	L	6	E0	i	2	E1	※5	-
90	M	6	E1	j	3	E2	※6	-
91	N	6	E2	k	5	E3	※7	-
92	O	6	E3	l	2	E4	※8	-
93	P	6	E4	m	6	E5	※9	-
94	Q	6	E5	n	5	E6	※10	-
95	R	6	E6	o	5	E7	※11	-
96	S	6	E7	p	5	E8	※12	-
97	T	6	E8	q	5	E9	※13	-
98	U	6	E9	r	5	EA	※14	-
99	V	6	EA	s	5	Eb	※15	-
9A	W	6	Eb	t	4	Ec	'	3
9b	X	6	Ec	u	5	Ed	*	6
9C	Y	6	Ed	v	5	EE	+	6
9d	Z	6	EE	w	6	EF	,	4
9E	0	6	EF	x	6	F0	-	5
9F	1	6	F0	y	5	F1	.	4
b0	2	6	d1	z	6	F2	/	6
b1	3	6	d2	Year	24(15)	F3	:	4
b2	4	6	d3	Month	18	F4	;	4
b3	5	6	d4	Date	12	F5	_	4
b4	6	6	d5	DOW	12	F6	&	8

NOTE: () is to indicate the following meanings:
 Code = d2: 2 digits setting of YEAR.
 Code = d6 and D7: AM/PM setting of HOUR.
 Code = d8 to dc: Number digits depend on the setting.

Language-Specific Character

English

	※1	※2	※3	※4	※5	※6	※7	※8	※9	※10	※11	※12	※13	※14	※15
Character	#	\$	@	[\]	^	`	{		}	~	EURO		
Dots	Bold	9	9	9	7	8	7	8	5	7	5	7	7	8	
	Large	7	6	7	6	6	6	6	4	6	4	6	6	7	
	Small	6	6	6	5	6	5	4	3	5	4	5	6	6	

Spanish

	※1	※2	※3	※4	※5	※6	※7	※8	※9	※10	※11	※12	※13	※14	※15
Character	Pt	\$	@	í	Ñ	¿	^	`	¨	ñ	}	~	EURO		
Dots	Bold	11	9	9	5	8	7	5	9	7	7	7	8		
	Large	8	6	7	4	7	6	4	7	7	6	6	7		
	Small	8	6	6	4	6	6	3	3	7	6	5	6	6	

German

	※1	※2	※3	※4	※5	※6	※7	※8	※9	※10	※11	※12	※13	※14	※15
Character	#	\$	§	Ä	Ö	Ü	^	`	ä	ö	ü	ß	EURO		
Dots	Bold	9	9	8	8	8	8	5	7	7	7	8	8		
	Large	7	6	7	7	7	7	6	4	7	6	7	7		
	Small	6	6	6	6	6	6	4	3	5	5	5	6	6	

French

	※1	※2	※3	※4	※5	※6	※7	※8	※9	※10	※11	※12	※13	※14	※15
Character	#	\$	à	°	ç	§	^	`	é	ù	è	¨	EURO		É
Dots	Bold	9	9	7	4	7	8	8	5	7	7	7	9	8	8
	Large	7	6	7	4	6	7	6	4	6	6	6	7	7	7
	Small	6	6	5	4	5	6	4	3	5	5	5	7	6	6

Italian

	※1	※2	※3	※4	※5	※6	※7	※8	※9	※10	※11	※12	※13	※14	※15
Character	#	\$	@	°	\	é	^	ù	à	ò	è	ì	EURO		
Dots	Bold	9	9	9	4	8	7	8	7	7	7	7	5	8	
	Large	7	6	7	4	6	6	6	6	7	6	6	4	7	
	Small	6	6	6	4	6	5	4	5	5	5	5	4	6	

Portuguese

	※1	※2	※3	※4	※5	※6	※7	※8	※9	※10	※11	※12	※13	※14	※15
Character	#	\$	@	[\]	^	`	{		}	~	EURO		
Dots	Bold	9	9	9	7	8	7	8	5	7	5	7	7	8	
	Large	7	6	7	6	6	6	6	4	6	4	6	6	7	
	Small	6	6	6	5	6	5	4	3	5	4	5	6	6	

Numeric

	※1	※2	※3	※4	※5	※6	※7	※8	※9	※10	※11	※12	※13	※14	※15
Character	#	\$	@	[\]	^	`	{		}	~	EURO		
Dots	Bold	9	9	9	7	8	7	8	5	7	5	7	7	8	
	Large	7	6	7	6	6	6	6	4	6	4	6	6	7	
	Small	6	6	6	5	6	5	4	3	5	4	5	6	6	

TROUBLESHOOTING

Error No. Appears

ERROR NO.	ERROR CONTENTS	CORRECTIVE ACTION
E-00	CPU error	Contact Acroprint at (800) 334-7190 (USA).
E-01	The remaining life of lithium battery for memory back-up is short.	
E-05	The card is not inserted in the Time Recorder properly.	Correctly insert the card.
E-30	Cannot print, the printer motor or home position sensor is not normal.	Make sure that the ribbon cassette is correctly inserted in place.
E-38	Cannot print, the printer head motor or the sensor does not operate properly.	Press the push bar.
E-40	Incorrect password	Enter the correct password again.
E-41	DST setting mistake	Confirm the correct starting and ending dates of daylight saving time and enter again.
E-49	Setting data you entered is not usable	Refer to your manual on the page related to the item you want to set and enter correct setting data.

Other Failures

ERROR	CORRECTIVE ACTION
Unit does not operate	Ensure the power cord is properly plugged into the wall outlet and power is available.
Unit does not print	Ensure the ribbon cassette is installed correctly and the proper print method is set.
Card is jammed	Press the push bar and try to pull out the card or paper at the same time.
Unit fails to hold memory	Replace lithium battery with Toshiba, part number ER3VT2.

SPECIFICATIONS

Clock Accuracy	Monthly accuracy \pm 15 sec. (at ordinary temperatures)
Calendar	Year up to 2099. Automatically adjusted to leap years, 31-day months and months with 30 or fewer days, and the days of the week.
Printing System	Dot matrix
Power Failure Compensation	Three years of cumulative power failure hours after the date of shipment.
Print at Power Failure	Optional Ni-Cd battery, 200 print registrations or 24 hours Acroprint part number 58-0108-000
Lithium Battery	Toshiba part number ER3VT2
Time Program	External time signal Built-in buzzer Printing an I-Mark™ (*)
Connection of External Signal	Connection with optional functions: External Alarm device : No voltage signal output. Master Clock device : 6 to 32 V signal input.
Operating Environment	Temperature: -5° to +45°C, +25° to +113°F Humidity: 20 to 80%, no condensation The unit operates normally at temperatures of 5°C (25°F) or below, but the print density and reaction of the liquid crystal display are inferior to those at normal temperature operation.
Dimensions	6.14" (w) x 7.13" (h) x 6.97" (d) 156 (w) x 181 (h) x 177 (d) mm
Weight	Approx. 4.0 lbs. (1.8 kg)
Rating	120 VAC 50/60 Hz 0.4 A 220-240 VAC 50/60 Hz 0.2 A

Product Registration Card

Mail, Fax to 919.850.0720, or Register Online at www.acroprint.com

ES900

Model No.

Serial No.

First Name

Last Name

Title

Company Name

Address

City

State

Zip

Daytime Phone with Area Code

Email Address

Fax#

Purchased From

Purchase Date

So that we may serve you better, please indicate your primary business activity:

Manufacturing

Hotel/Motel

Wholesale

Banking/Financial

Retail

Medical/Dental

Government

Construction

University/School

Other _____

Restaurant

Number of Employees using this product:

1-10

50-75

11-25

76-100

26-49

100+

Annual Sales in dollars:

Under \$100,000

\$500,000 – 1,000,000

\$100,000 – 250,000

\$1,000,000 – 5,000,000

\$250,000 – 500,000

\$5,000,000+

Are you interested in receiving information on any other Acroprint products:
(check all that apply)

Manual Time Clocks

Human Resources Software

Electronic Time Clocks

Data Collection Terminals

Time Stamps

Biometrics

Time and Attendance Software

How likely is it that you would recommend Acroprint to a friend or colleague?

0 1 2 3 4 5 6 7 8 9 10

Not at all likely

Neutral

Extremely likely

Cut Here



5640 Departure Drive
Raleigh, NC 27616 USA
919.872.5800
800.334.7190 (in USA)
919.850.0720 (Fax)
www.acroprint.com
sales@acroprint.com