

# Echelon EH Series Floor Scale Set-up

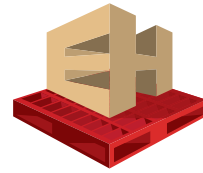

**ECHELON**

EH-544 / EH-1044  
Economy Floor Scale

**1** Locate box of feet in carton on underside of scale.



**2** Screw foot into load cell at each corner.

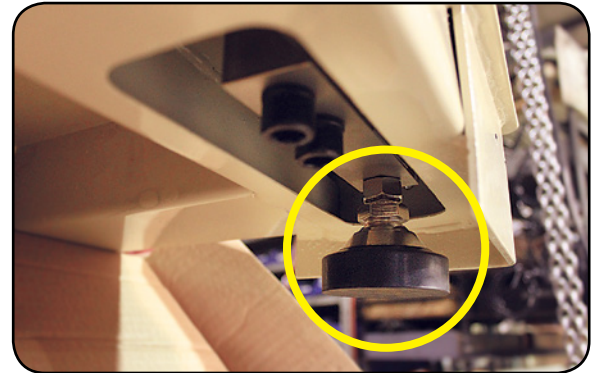

**3** Remove the two screws and scale side cover from scale.

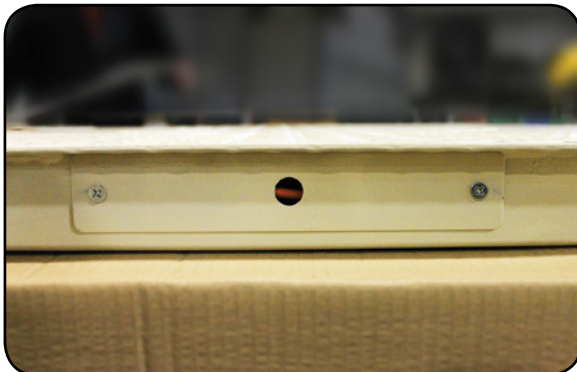

**4** Remove junction box from scale.

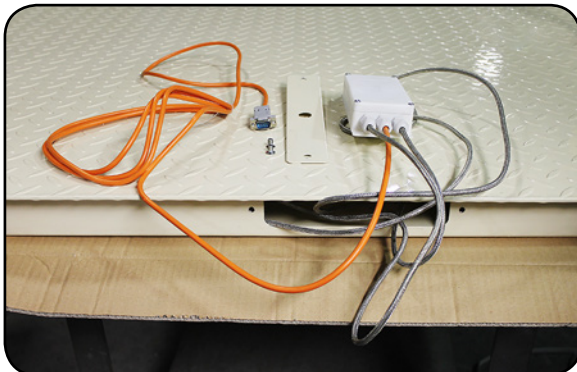

- 5 Remove the four screws and cover of the junction box.

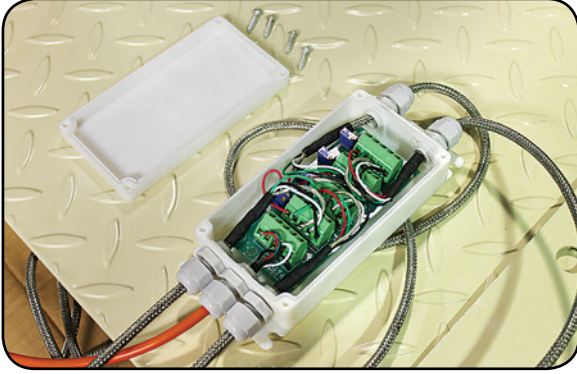

- 6 Remove indicator cable wires from terminal block.

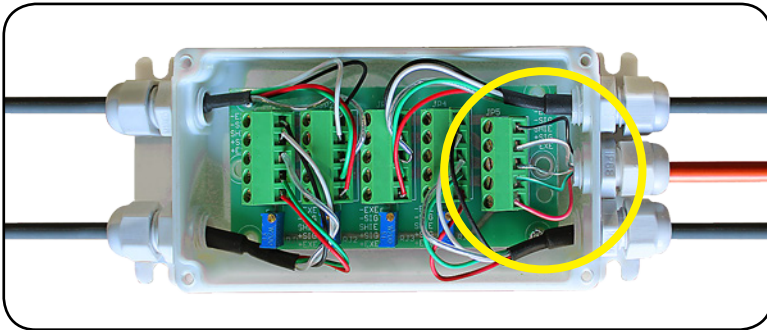

**Note location of wires:**

- EXE Black
- SIG White
- SHIELD May be any color
- + SIG Green
- + EXE Red

- 7 Route indicator cable through the scale side cover.

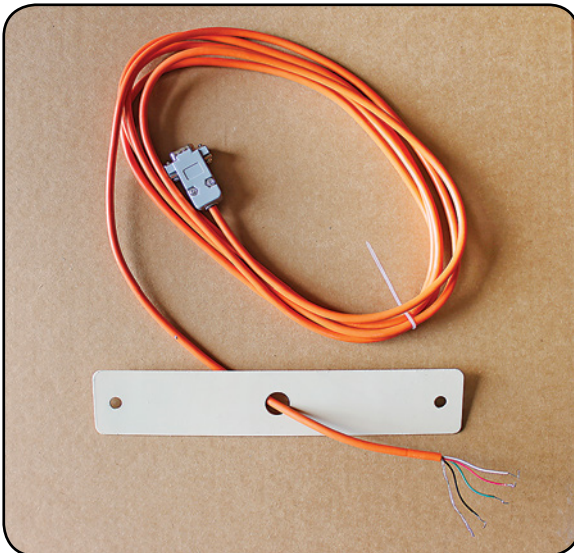

- 8** Re-connect indicator cable wires to terminal block in junction box. Ensure wires are reconnected to the proper terminals.

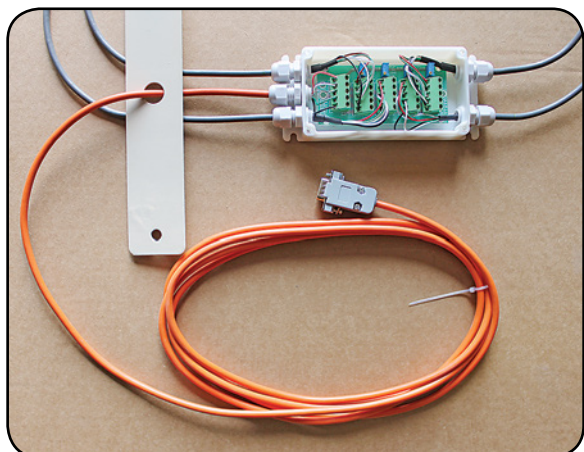

**Note location of wires:**

- EXE    Black
- SIG    White
- SHIELD**    May be any color
- + SIG    Green
- + EXE    Red

- 9** Replace cover on junction box and secure with four screws.



- 10** Place junction box in scale and re-install side cover.



**Scale is now ready to connect to digital weight indicator and calibrate.**