

# Owner's Manual

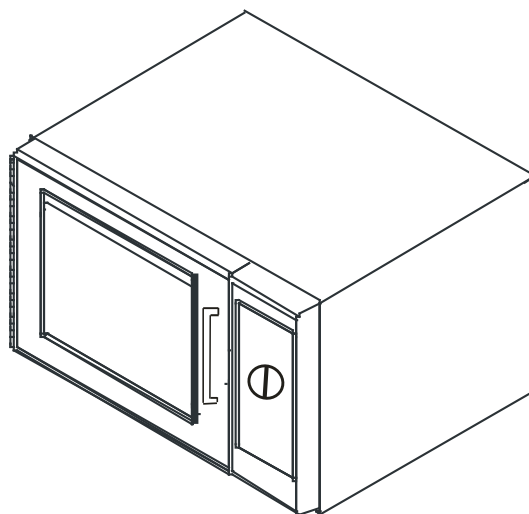
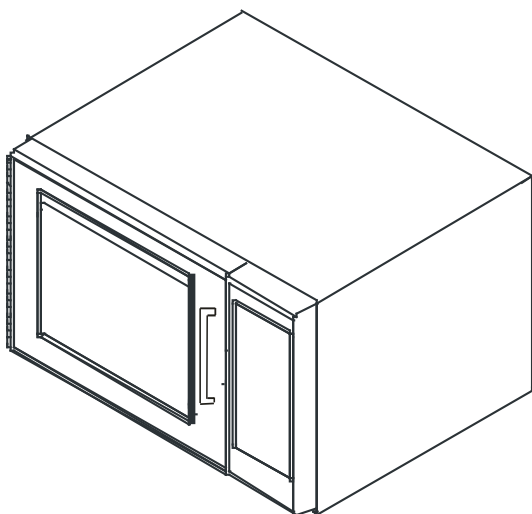

## Commercial Microwave Oven

Keep these instructions for future reference.  
If the oven changes ownership, this manual  
must accompany oven.

### Contents

Model Identification .....	2
<b>PRECAUTIONS TO AVOID POSSIBLE EXPOSURE TO EXCESSIVE MICROWAVE ENERGY .....</b>	<b>3</b>
<b>IMPORTANT SAFETY INSTRUCTIONS ...</b>	<b>3</b>
Installation .....	5
Earthing Instructions .....	5
Electronic Control Operation .....	6
Dial Control Operation.....	10
Care and Cleaning .....	11
Before Calling for Service .....	12

# Model Identification

---

When contacting ACP, provide product information. Product information is located on oven serial plate which is located on the back side of the oven. Record the following information:

Model Number: \_\_\_\_\_

Manufacturing Number: \_\_\_\_\_

Serial or S/N Number: \_\_\_\_\_

Date of purchase: \_\_\_\_\_

Dealer's name and address: \_\_\_\_\_

\_\_\_\_\_

\_\_\_\_\_

\_\_\_\_\_

Any questions or to locate an authorized ACP servicer, call toll free 1-866-426-2621 inside the U.S.A or Canada, or 1-319-368-8120 outside the U.S.A or Canada.

Warranty service must be performed by an authorized ACP servicer. ACP also recommends contacting an authorized ACP servicer if service is required after warranty expires.

# IMPORTANT SAFETY INSTRUCTIONS



Recognize this symbol as a **SAFETY** message



## WARNING

When using electrical equipment, basic safety precautions should be followed to reduce the risk of burns, electrical shock, fire, or injury to persons.

1. READ all instructions before using equipment.
2. READ AND FOLLOW the specific "PRECAUTIONS TO AVOID POSSIBLE EXPOSURE TO EXCESSIVE MICROWAVE ENERGY" on this page.
3. This equipment **MUST BE EARTHED**. Connect only to properly **EARTHED** outlet. See "EARTHING INSTRUCTIONS" on page 5.
4. Install or locate this equipment **ONLY** in accordance with the installation instructions in this manual.
5. Some products such as whole eggs and sealed containers—for example, closed glass jars—are able to explode and **SHOULD NOT** be **HEATED** in this oven.
6. Use this equipment **ONLY** for its intended use as described in this manual. Do not use corrosive chemicals or vapors in this equipment. This type of oven is specifically designed to heat, cook, or dry food. It is not designed for industrial or laboratory use.
7. As with any equipment, **CLOSE SUPERVISION** is necessary when used by **CHILDREN**.
8. See door cleaning instructions in the product safety manual.
9. **DO NOT** heat baby bottles in oven.
10. Baby food jars shall be open when heated and contents stirred or shaken before consumption, in order to avoid burns.
11. **DO NOT** operate this equipment if it has a damaged cord or plug, if it is not working properly, or if it has been damaged or dropped.
12. This equipment, including power cord, must be serviced **ONLY** by qualified service personnel. Special tools are required to service equipment. Contact nearest authorized service facility for examination, repair, or adjustment.
13. **DO NOT** cover or block filter or other openings on equipment.
14. **DO NOT** store this equipment outdoors. **DO NOT** use this product near water – for example, near a kitchen sink, in a wet basement, a swimming pool, or a similar location.
15. **DO NOT** immerse cord or plug in water.
16. Keep cord **AWAY** from **HEATED** surfaces.
17. **DO NOT** let cord hang over edge of table or counter.
18. For commercial use only.

## PRECAUTIONS TO AVOID POSSIBLE EXPOSURE TO EXCESSIVE MICROWAVE ENERGY

- A. **DO NOT** attempt to operate this oven with the door open since open door operation can result in harmful exposure to microwave energy. It is important not to defeat or tamper with the safety interlocks.
- B. **DO NOT** place any object between the oven front face and the door or allow soil or cleaner residue to accumulate on sealing surfaces.
- C. **DO NOT** operate the oven if it is damaged. It is particularly important that the oven door close properly and that there is no damage to the:
  1. door (bent)
  2. hinges and latches (broken or loosened)
  3. door seals and sealing surfaces.
- D. The oven should not be adjusted or repaired by anyone except properly qualified service personnel.

**SAVE THESE INSTRUCTIONS**

# IMPORTANT SAFETY INSTRUCTIONS



## WARNING

To avoid risk of fire in the oven cavity:

- a. DO NOT overcook food. Carefully attend oven when paper, plastic, or other combustible materials are placed inside the oven to facilitate cooking.
- b. Remove wire twist-ties from paper or plastic bags before placing bag in oven.
- c. If materials inside the oven ignite, keep oven door CLOSED, turn oven off and disconnect the power cord, or shut off power at the fuse or circuit breaker panel.
- d. DO NOT use the cavity for storage. DO NOT leave paper products, cooking utensils, or food in the cavity when not in use.



## WARNING

Liquids such as water, coffee, or tea are able to be overheated beyond the boiling point without appearing to be boiling due to surface tension of the liquid. Visible bubbling or boiling when the container is removed from the microwave oven is not always present. THIS COULD RESULT IN VERY HOT LIQUIDS SUDDENLY BOILING OVER WHEN A SPOON OR OTHER UTENSIL IS INSERTED INTO THE LIQUID. To reduce the risk of injury to persons:

- i) Do not overheat the liquid.
- ii) Stir the liquid both before and halfway through heating it.
- iii) Do not use straight-sided containers with narrow necks.
- iv) After heating, allow the container to stand in the microwave oven for a short time before removing the container.
- v) Use extreme care when inserting a spoon or other utensil into the container.



## CAUTION

To avoid personal injury or property damage, observe the following:

1. Do not deep fat fry in oven. Fat could overheat and be hazardous to handle.
2. Do not cook or reheat eggs in shell or with an unbroken yolk using microwave energy. Pressure may build up and erupt. Pierce yolk with fork or knife before cooking.
3. Pierce skin of potatoes, tomatoes, and similar foods before cooking with microwave energy. When skin is pierced, steam escapes evenly.
4. Do not operate equipment without load or food in oven cavity.
5. Use only popcorn in packages designed and labeled for microwave use. **Popping time varies depending on oven wattage.** Do not continue to heat after popping has stopped. Popcorn will scorch or burn. Do not leave oven unattended.
6. Do not use regular cooking thermometers in oven. Most cooking thermometers contain mercury and may cause an electrical arc, malfunction, or damage to oven.
7. Do not use metal utensils in oven.
8. Never use paper, plastic, or other combustible materials that are not intended for cooking.
9. When cooking with paper, plastic, or other combustible materials, follow manufacturer's recommendations on product use.
10. Do not use paper towels which contain nylon or other synthetic fibers. Heated synthetics could melt and cause paper to ignite.
11. Do not heat sealed containers or plastic bags in oven. Food or liquid could expand quickly and cause container or bag to break. Pierce or open container or bag before heating.
12. To avoid pacemaker malfunction, consult physician or pacemaker manufacturer about effects of microwave energy on pacemaker.
13. An authorized servicer MUST inspect equipment annually. Record all inspections and repairs for future use.
14. Clean oven regularly and remove any food deposits.
15. To avoid surface deterioration, keep the oven in a clean condition. Infrequent cleaning could adversely affect the life of the appliance and possibly result in a hazardous situation.

# SAVE THESE INSTRUCTIONS

# Installation

## Unpacking Oven

- Inspect oven for damage such as dents in door or inside oven cavity.
- Report any dents or breakage to source of purchase immediately.  
**Do not attempt to use oven if damaged.**
- Remove all materials from oven interior.
- If oven has been stored in extremely cold area, wait a few hours before connecting power.

## Radio Interference

Microwave operation may cause interference to radio, television, or a similar oven. Reduce or eliminate interference by doing the following:

- Clean door and sealing surfaces of oven according to instructions in *Care and Cleaning* section.
- Place radio, television, etc. as far as possible from oven.
- Use a properly installed antenna on radio, television, etc. to obtain stronger signal reception.

## Oven Placement

- Do not install oven next to or above source of heat, such as pizza oven or deep fat fryer. This could cause microwave oven to operate improperly and could shorten life of electrical parts.
- Do not block or obstruct oven filter. Allow access for cleaning.
- Install oven on level countertop surface.
- Place warning label in a conspicuous place close to microwave oven.
- Outlet should be located so that plug is accessible when oven is in place.

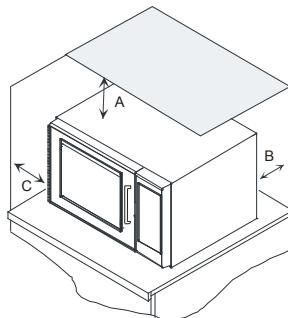

- A—For North American (UL/CSA) models, allow at least 3" (7.6 cm) of clearance around top of oven. For International (50 Hz) models, allow at least 12" (30 cm) of clearance around top of oven. Proper air flow around oven cools electrical components. With restricted air flow, oven may not operate properly and life of electrical parts is reduced.
- B—Allow at least 3" (7.6 cm) between air discharge on back of oven and back wall.
- C—Allow at least 3" (7.6 cm) of clearance around side of oven. One side of oven must be open.

Oven Clearances

### WARNING

To avoid risk of electrical shock or death, this oven must be earthed.

### WARNING

To avoid risk of electrical shock or death, do not alter the plug.

## Grounding/Earthing Instructions

### Oven **MUST** be grounded.

Grounding reduces risk of electric shock by providing an escape wire for the electric current, if an electrical short occurs. This oven is equipped with a cord having a ground wire with a grounding plug. The plug must be plugged into an outlet that is properly installed and grounded.

Consult a qualified electrician or servicer if grounding instructions are not completely understood, or if doubt exists as to whether the oven is properly grounded.

### **Do not use an extension cord.**

If the product power cord is too short, have a qualified electrician install a three-slot receptacle. This oven should be plugged into a separate circuit with the electrical rating as provided in product specifications (available at [www.acpsolutions.com](http://www.acpsolutions.com)). When a microwave oven is on a circuit with other equipment, an increase in cooking times may be required and fuses can be blown.

## External Equipotential

### Earthing Terminal (*export only*)

Equipment has secondary earthing terminal. Terminal provides external earthing connection used in addition to earthing prong on plug. Located on outside of oven back, terminal is marked with symbol shown below.



# Electronic Control Operation

## So...how do I use it?

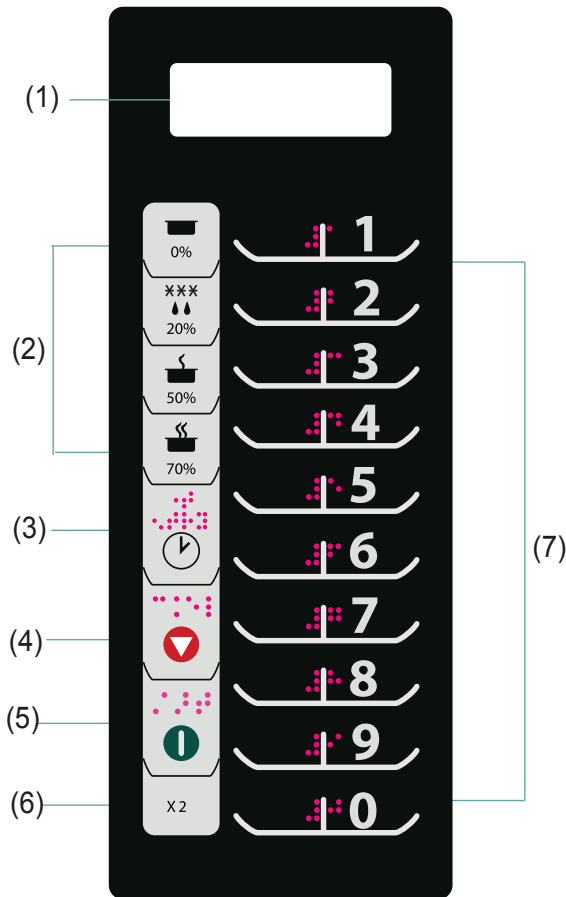

- (1) LED Display
- (2) Power Level Keys
- (3) Time Entry Key
- (4) Stop/Cancel Key
- (5) Start Key
- (6) X2 Key
- (7) Number Keys

### 1. Power Up

“-- --” displays when the oven is powered up for the first time. If  key is pressed, the oven will change to Idle Mode.

**Note:** In Idle mode, no key can be pressed.

### 2. Idle Mode

1) The oven will enter Idle Mode after a set number of seconds have expired in Ready Mode without a keypad pressed or without the door being opened and closed. The default number of seconds is 60 and maybe changed by resetting User Option 4.

2) During Idle Mode, LED is blank. There will be no oven activity.

3) Open and close the oven door to exit the Idle Mode and go into Ready Mode.

### 3. Ready Mode

1) In this mode, the oven is ready to either begin a manual or preset cook cycle.

2) Opening and closing the door while the oven is in Idle Mode will put the oven into Ready Mode.

3) During Ready Mode LED displays “0:00”.

### 4. Door Open Mode

1) While the door of the oven is open, the oven will be in Door Open Mode. This allows for entry into Programming Mode.

2) During this mode, LED is blank, the fan operates and oven light is on.



3) When the door is opened and closed, if User Option OP:60 is selected and the oven was running a manual or preset cook cycle, the oven will enter Pause Mode.

If User Option OP:61 is selected and the oven was running a manual or preset cooking cycle, opening and closing the door will clear all preset cook cycle information.

The switching operation of this microwave oven can cause voltage fluctuations on the supply line. The operation of this oven under unfavorable voltage supply conditions can have adverse effects. This device is intended for the connection to a power supply system with a maximum permissible system impedance  $Z_{max}$  of **0.2 Ohms** at the interface point of the user's supply. The user has to ensure that this device is connected only to a power supply system which fulfills the requirement above. If necessary, the user can ask the public power supply company for the system impedance at the interface point.





# Electronic Control Operation



## 5. Pause Mode

- 1) This mode allow users to temporarily stop the cooking cycle to inspect or stir the food item.
- 2) While in Time Entry Mode or Preset Program Cook Mode, if the door is open and closed, or if the  key is pressed, the oven will enter Pause Mode.
- 3) While paused, LED will display the remaining cooking time.
- 4) Pause Mode will expire back to Idle Mode in the exact fashion as Ready Mode, dependent on User Option 61.
- 5) Additionally, if the  key is pressed, the oven will immediately enter Ready Mode. If  key is pressed, the oven will resume the cooking cycle.



## 6. Time Entry Mode

- 1) The user may manually enter a cook time and power level while in this mode.
- 2) While the oven is in the Ready Mode, pressing the  key will put the oven into Time Entry Mode.
- 3) During this mode, "00:00" displays.

4) Press ,  , or  key to select power level, LED will display the related power. If the same key is pressed twice, the power will change to PL10 ( Power Level 10 or full power). If no power chosen, PL10 is default.

- 5) During setting process, press  key to enter Time Entry Mode and begin cooking. Press  key to enter Ready Mode.

## 7. Manual Cook Mode

- 1) This mode allows cooking of the food items. While in Manual Cook Entry Mode, pressing the  key will cause to the oven to begin Manual Cook Mode.
- 2) During this mode, cooking time displays. The fan operates and oven light is on.
- 3) When cooking program is finished, the oven will enter End of Cook Cycle Mode. If you press  key while in this mode, the oven will enter Pause Mode.

## 8. End of Cook Cycle Mode

- 1) After the time has expired in a Manual Cook Mode, or a Preset Program Cook Mode, the oven will go into The End of Cook Cycle Mode.
- (2) During this mode, "End" displays.

- (3) If either User Option OP:11 or OP:12 is selected, the oven will continue to sound until the user acknowledges by either opening and closing the door or pressing the  key. User Option OP:10 is the default and after the 3 second beep, the oven will go into Ready Mode.

## 9. Preset Program Cook Mode

- 1) This mode allows cooking of food items through a one key touch operation. While in Ready Mode, pressing a Number Key on the keypad will cause the oven to run the Preset Program associated with that key.
- 2) LED displays the remaining cooking time. If it is multi-stage cooking, the total remaining cooking time displays not a particular stage cooking time.
- (3) If the program chosen exceeds the maximum time allowed by User Option 7, then the oven will beep three times and display 00:00 to indicate the program is unacceptable.

- (4) When the cooking program finishes, the oven will enter End of Cook Cycle Mode. If you press  key while in this mode, the oven will enter Pause Mode.

## Factory Preset Time Settings

Preprogrammed Pad	Time:
1	10 sec.
2	20 sec.
3	30 sec.
4	45 sec
5	1 min.
6	1:30 min.
7	2 min.
8	3 min.
9	4 min.
0	5 min.



## 10. On the Fly Cooking

- 1) The user may start another cook cycle while the oven is operating or paused.
- 2) While the oven is operating or while in the Pause Mode and if User Option OP:51 is selected pressing a Number Key will automatically start the preset cooking program associated with the selected number key.
- 3) LED displays the remaining cooking time.
- 4) When cooking program finish, the oven will enter End of Cook Cycle Mode. If you press  key while in this mode, the oven will enter Pause Mode.



# Electronic Control Operation

## 11. Programming Mode

- 1) This mode allows the user to assign cook times and power levels to the keypad number keys.
  - 2) Open the door and press Number Key 1 for 5 seconds. The buzzer sounds once to indicate Programming Mode is activated.
  - 3) LED displays "ProG".
  - 4) Press a number key to change or review setting.
  - 5) Press  key, LED will display the saved time. Input the desired new time.
  - 6) Press  0%, 20%, 50%, or 70% to input the power level.
- LED will display the related power. If the same key is pressed twice, the power will change to PL10 ( Power Level 10 or full power). If no power chosen, PL10 is the default.
- 7) If X2 is pressed, LED displays "CF:80". The default factor of 80%. To change the cooking factor, press desired Number Key for new factor.
  - 8) After setting the time and power, press  key to save the cooking program. LED displays "ProG".

- 9) If total cooking time entered exceeds the maximum time allowed User Option 7, when  key is pressed to save the program. If the program chosen exceeds the maximum time allowed by User Option 7, then the oven will beep three times and display 00:00 to indicate the program is unacceptable.

- 10) Close the door and the oven will return to Ready Mode.

Press  key and the oven will return to Door Open Mode.

- 11) Program example for a cook setting of 1 minute and 25 seconds at 70% power.

Step1: Open oven door and press Number Key "1" for 5 seconds, LED displays "ProG".

Step 2: Press Number Key "3". The program will be saved in "3".

Step 3: Press  key, LED displays "0:00".

Step 4: Press Number Keys "1", "2" and "5" to input the cooking time, LED displays 1:25.

Step 5: Press  70% key to input 70% power level. LED displays "PL7".

Step 6: Press  key to save. To use this program

press "3". The oven will start operating for 1:25 @70% power.

### Note:

1. If the electric supply is interrupted, the saved program will not be lost.

2. Pressing  key returns the oven to Ready Mode and cancels entered settings

## 12. Double Quantity Cooking

- 1)The X2 pad allows two quantities of the same food item to be cooked at once

- 2) Press X2 key and then Preset Program Number(s) 0-9 within 5 seconds. The oven will start cooking per the quantity preset cooking time.

- 3) Press X2, LED displays "doub". Press preprogrammed number key, LED displays the cooking time for two quantities.

Example: If number "5" key is programmed to cook for 1:00, when first pressing X2 key and then pressing number "5" key, the oven will automatically set the cook time to 1:48. (1:00 cook cycle x 80% "X2" cook factor = 1:48)

- 4) When the cooking program finishes, the oven will enter End of Cook Cycle Mode.

**Note:** X2 function may be used only with Programming Mode cooking.

## 13. Stage Cooking Programming

- 1) This allows food items to be cooked using a combination of various Power Levels and times.

- 2) A maximum of three stages can be set.

After setting the power and time for the first stage, press

-  key to set the second stage.

Repeat to set the third stage.

- 3) When setting the second and the third stage, press  key LED displays "S-2" or "S-3".

- 4) Press  key to start cooking.

Program example for two stages. Stage 1: 1 minute 25 seconds @ 70% power; Stage 2: 5 minutes 40 seconds @50% power.

Step 1: Open oven door and press Number Key "1" for 5 seconds LED displays "ProG".

Step 2: Press Number Key "3". The program will be saved in "3".



# Electronic Control Operation

Step 3: Press  key, LED displays "00:00".

Step 4: Press Number Keys "1", "2", "5" to input the cooking time. LED displays "1:25".

Step 5: Press  key to input 70% power, LED displays "PL7".

The first stage is finished.

Step 6: Press  key, LED displays "S-2".

Step 7: Press Number Keys "5", "4", "0" button, LED displays "5:40".

Step 8: Press  key to input 50% power, LED displays "PL5". The second stage is finished.

Step 9: Press  key to save. To use this program press "3". The oven will start operating for 7:05 (1:25 @ 70% power + 5:40 @50% power).

## 14. Use Option Mode

1) This allows the user to choose various oven operations.

2) Open the oven door and press Number Key "2" for 5 seconds. The buzzer sounds once to indicate User Option Mode is activated.

3) LED displays "OP: - -".

4) Press any Number Key to enter related options as noted in chart below.

Example: To set the buzzer or key beep volume to medium, Press Number Key "2" "OP:22" displays.

To change, repeat pressing "2" LED displays "OP:20", "OP:21" "OP:22" "OP:23" etc.

Number Keys	Display	Options (Factory Settings in Bold)
1 End of Cycle Beep	<b>OP:10</b> OP:11 OP:12	<b>3 second beep.</b> Continuous beep until door is opened. 5 beep bursts until door is opened.
2 Key Beep Volume	OP:20 OP:21 <b>OP:22</b> OP:23	Eliminates beep. Sets volume to low. <b>Sets volume to medium.</b> Sets volume to high.
3 Key Beep	OP:30 <b>OP:31</b>	Prevents beep when Number Key is pressed. <b>Allows beep when Number Key is pressed.</b>
4 Active Display	OP:40 OP:41 <b>OP:42</b> OP:43	15 seconds after oven door is opened, keyboard disabled. 30 seconds after oven door is opened, keyboard disabled. <b>1 minute after oven door is opened, keyboard disabled.</b> 2 minutes after oven door is opened, keyboard disabled.
5 On-the Fly Cooking	OP:50 <b>OP:51</b>	Prevents different pre-programmed Number Key to be activated during cooking. <b>Allows different pre-programmed Number Key to be activated during cooking.</b>
6 Reset to Ready Mode	<b>OP:60</b> OP:61	<b>Opening oven door does not reset oven back to ready mode.</b> Opening oven door resets oven back to ready mode.
7 (some models) Maximum Heating Time	<b>OP:70</b> OP:71	<b>Allows 60 minutes of heating time (some models).</b> Allows 10 minutes of heating time.
8 Manual Operation	OP:80 <b>OP:81</b>	Allows use of preprogrammed Number Key only. <b>Allows use of manual time entry and preprogrammed Number Key.</b>
9 (some models) Double Digit Operation	<b>OP:90</b> OP:91	<b>Allows 10 (0-9) preprogrammed Number Key.</b> Allows 100 (00-99) preprogrammed Number Key.
0 Clean Filter Message	OP:00 <b>OP:01</b> OP:02 OP:03	Do not display message. <b>Display message for 24 hours every 7 days.</b> Display message for 24 hours every 30 days. Display message for 24 hours every 90 days.

## So...how do I use it?

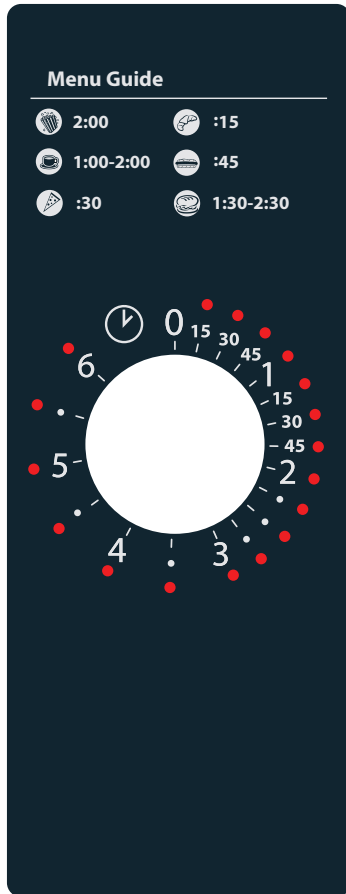

### Heating

1. Open oven door, place food in oven, and close oven door.
2. Turn time entry knob clockwise to desired time.
  - Cooking time can be set up to 6 minutes.
  - Oven begins operation and time counts down.
3. When cooking time has elapsed, microwave energy stops and oven signal sounds.

### Interrupting Operation

Open oven door to interrupt operation or turn time entry knob counterclockwise to "0".

When cooking is interrupted by opening door, oven automatically resets to zero time.

To resume microwave oven operation, close door and re-enter desired time by turning knob clockwise.

### Changing Time and Canceling Mistakes

Heating time can be changed at any time while the oven is operating.

Turn knob to desired new setting. To set cooking time to zero, turn knob counterclockwise to "0". Setting the time to zero cancels the set cooking time and turns the oven off.

# Care and Cleaning



## WARNING

To avoid electrical shock which can cause severe personal injury or death, unplug power cord or open circuit breaker to oven before cleaning or removing light bulb.

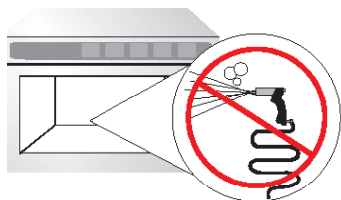

**DO NOT** power spray

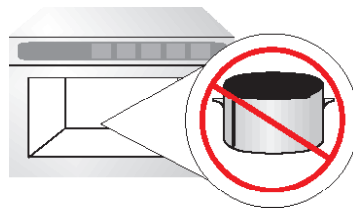

**No** metal pans

PART	CARE AND CLEANING RECOMMENDATION
Interior, Exterior, and Door	<p>Clean microwave oven with mild detergent in warm water using soft sponge or cloth. Wring sponge or cloth to remove excess water before wiping equipment. If desired, boil a cup of water in microwave oven to loosen soil before cleaning.</p> <p><b>Important:</b></p> <ul style="list-style-type: none"> <li>• Do not use abrasive cleansers or cleaners containing ammonia or citrus. These could damage finish.</li> <li>• Never pour water into microwave oven bottom.</li> <li>• Do not use water pressure type cleaning systems.</li> </ul>
Discharge Air Vents	<p>Check monthly for a buildup of cooking vapors along intake and discharge louvers on bottom and back of oven. Clean air vents with damp cloth to ensure proper airflow. Dry thoroughly.</p>
Control Panel	<p>Open oven door to deactivate oven timer. Clean with mild detergent in warm water using soft sponge or cloth.</p>

# Before Calling for Service



## WARNING

To avoid electrical shock which can cause severe personal injury or death, do not remove outer case at any time. Only an authorized ACP servicer should remove outer case.

## Troubleshooting

Complaint	Possible Cause	Remedy
Dim oven light	Cooking at low power level.	This is normal
Steam forms on oven door	When cooking foods in a microwave steam is generated.	This is normal
Hot air expelled from vents	Foods cooking in a microwave may release heat.	This is normal
Oven does not start.	Power cord not plugged in correctly.	Plug cord into outlet correctly.
	Fuse blown or circuit breaker open.	Replace fuse (should be repaired by authorized servicer) or reset breaker.
	Malfunctioning outlet	Test outlet with other electrical appliances.
	Door not closed.	Close door.

For full product documentation visit:  
[www.acpsolutions.com](http://www.acpsolutions.com)