

Model: 45-6840

Date Code: CPSIA#2-45-6840-_____-GR

Purchase Date: _____



84" Billiard Table with Table Tennis Top



Please keep this instruction manual for future reference

If you have any problems with your new product, please contact Escalade Sports at 1-888-996-2729 or e-mail us at gameroom@escaladesports.com for any technical support or warranty issues.

Limited 90-Day Warranty

All Triumph Sports USA (TSU) games have a limited 90-day from date of purchase warranty. This warrants the retail purchaser for any TSU game purchased to be free from any defect in materials and construction for 90 days from the date of purchase. The only exceptions to the warranty include main frames, tabletops, playing surfaces, batteries or tools. Damaged main frames, tabletops, playing surfaces need to be returned to the store as we are unable to replace these parts. Normal play wear and usage is not covered under the warranty, nor is wear or damage due to improper use of the TSU game. This will void any and all TSU warranties.

A PURCHASE RECEIPT (or other proof of purchase date) will be required before any warranty service is initiated. All requests for warranty service can be submitted by email, in writing or by contacting our Customer Service Department at: 1-888-996-2729 or email us at gameroom@escaladesports.com.

IMPORTANT NOTICE! Please contact us before returning the product to the store.

Warnings



WARNING: Choking Hazard—Product contains small balls and small parts.
Not for children under 3 years of age.

Be sure to check out all the exciting games  has to offer.

Visit our web site at:

www.triumphsportsusa.com



BILLIARDS



DARTS



GAME TABLES



CASINO













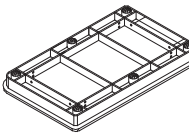

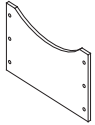
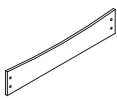









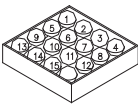

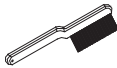

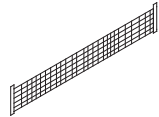
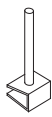
OUTDOOR GAMES

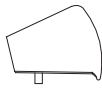

DARTBOARDS

Escalade@Sports
817 Maxwell Avenue
Evansville, IN 47711
www.triumphsportsusa.com
2016 Escalade@Sports. All Rights Reserved.

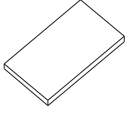
Parts List

 <p>CABINET FOR BILLIARD 1 PC</p>	 <p>LEFT LEG 2 PCS</p>	 <p>RIGHT LEG 2 PCS</p>	 <p>END LEG BRACE 2 PCS</p>	 <p>SIDE LEG BRACE 2 PCS</p>	 <p>5/16"X1-1/4" LEG BOLT 12 PCS</p>
 <p>1/4"X1" LEG BOLT 8 PCS</p>	 <p>5/16"XØ19X1.5 MM WASHER 12 PCS</p>	 <p>1/4"XØ15X1 MM WASHER 8 PCS</p>	 <p>4X12MM WASHER HEAD SCREW 12 PCS</p>	<p>(Packed in Playfield)</p>  <p>TABEL TENNIS SUPPORT 2 PCS</p>	 <p>CUE STICK 2 PCS</p>
 <p>CHALK 2 PCS</p>	 <p>TRIANGLE RACK 1 PC</p>	 <p>BILLIARD BALLS 1 SET</p>	 <p>LEG LEVELER 4 PCS</p>	 <p>BRUSH 1 PC</p>	 <p>TABEL TENNIS PADDLE 2 PCS</p>
 <p>TABEL TENNIS BALL 2 PCS</p>	 <p>TABEL TENNIS NET 1 PC</p>	 <p>POST 2 PCS</p>	<p>(Packed in Playfield)</p>  <p>TABEL TENNIS SURFACE HALF-A 2 PCS</p>	 <p>T - NUT (PRE-INSTALLED) 12 PCS</p>	 <p>SIDE POCKET CAP WITH NAIL (PRE-INSTALLED) 2 PCS</p>
 <p>CORNER POCKET CAP WITH NAIL (PRE-INSTALLED) 4 PCS</p>	 <p>TOP CORNER CAP (PRE-INSTALLED) 4 PCS</p>	 <p>FABRIC POCKET (PRE-INSTALLED) 6 PCS</p>	 <p>APRON CORNER (PRE-INSTALLED) 4 PCS</p>	 <p>ALLEN WRENCH 1 PC</p>	 <p>TABEL TENNIS SURFACE HALF-B 1 PC</p>
 <p>WARNING: CHOKING HAZARD Small parts. Not for children under 3 yrs.</p>					<p>31</p>  <p>EVA PAD 4 PCS</p>

Assembly Tips

Attention: If you are using an electric screwdriver in the assembly, please set at low torque and do not over tighten the hardware. When assembling individual parts, loosely tighten screws until all screws are inserted, then tighten completely.

Assembly Instructions

NOTE: We recommend that two adults work together to assemble this game.

Step 1

Find a clean, level place to begin the assembly of your billiard table. The table will be assembled upside down and then turned over on its legs once the assembly is completed.

Step 2

Remove all the parts from the box and verify that you have all of the parts as shown on the parts list above. Carefully cut or tear the four corners of the box so that the bottom of the box can be used as your work surface.

Step 3

Place the pre-assembled cabinet (#1) face down in your work area.

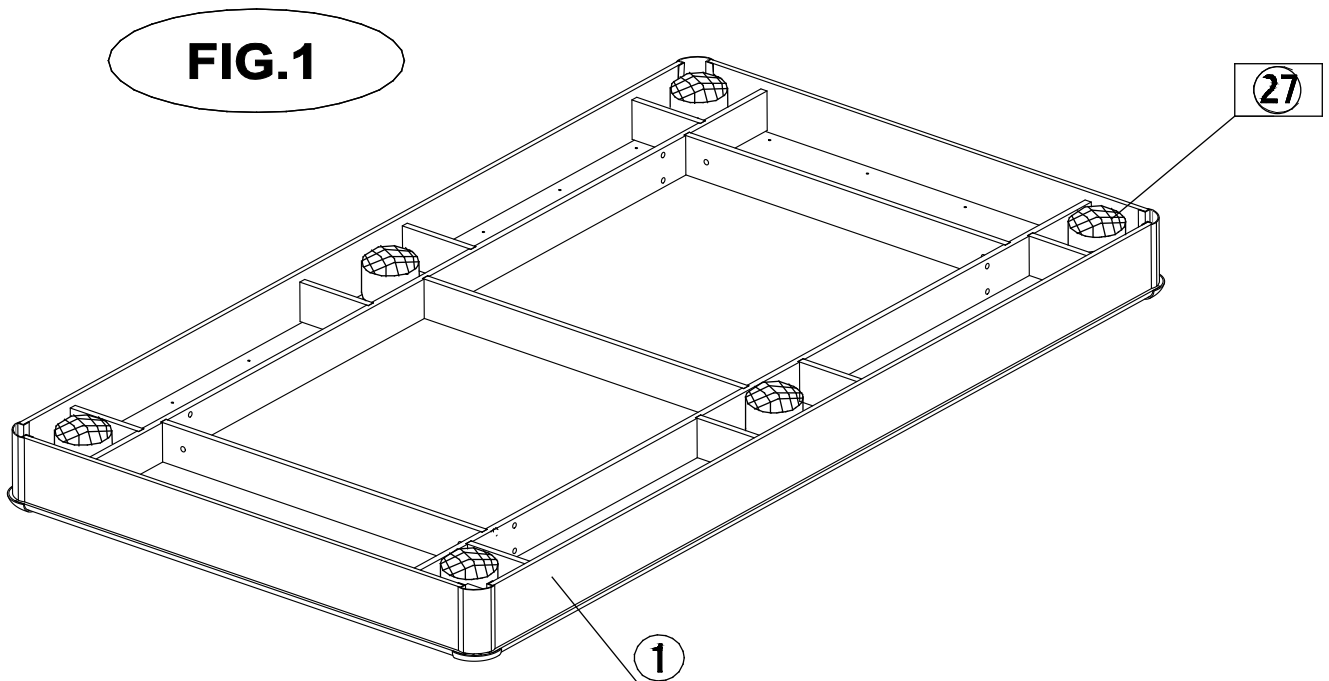

PART REQUIRED:

- 2 pcs - #2 Left Leg
- 2 pcs - #3 Right Leg
- 12 pcs - #6 Allen Head Bolt
- 12 pcs - #8 Flat Washer
- 4 pcs - #16 Leg Leveler
- 1 pc - #29 Allen Wrench

Step 4

Attach Left (#2) and Right (#3) Legs to support frame using three of Leg Bolts (#6) and three Washers (#8) per leg. Then locate the four Leg Levelers (#16) and screw one into each Leg. See FIG.2.

Do not tighten #6 Bolts until completion of STEP 6.

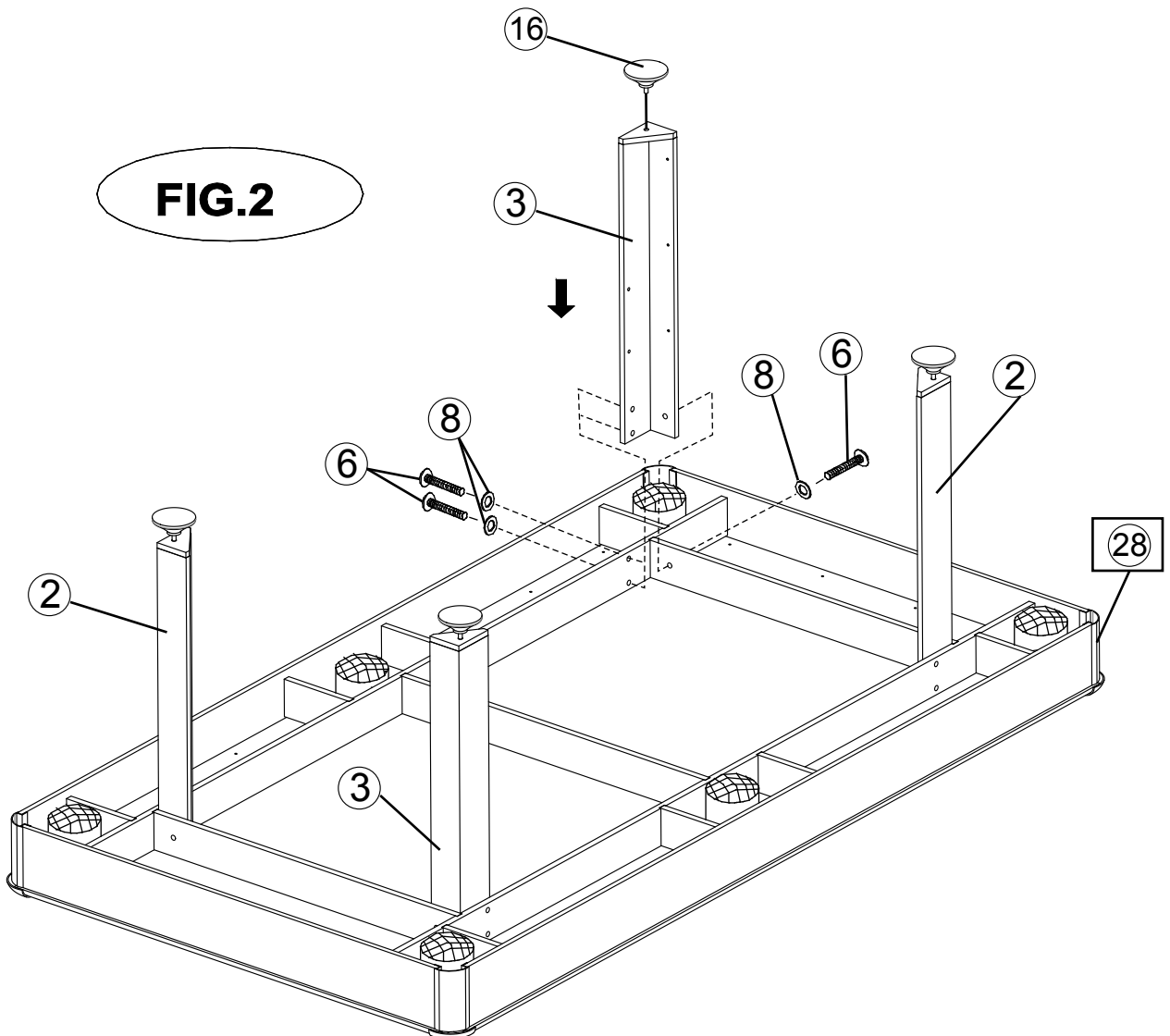

PART REQUIRED:
2 pcs - #4 End Leg Braces
12 pcs - #10 Screws

Step 5

Attach End Leg Braces (#4) to Legs using six Screws (#10) per Leg. See FIG.3.

FIG.3

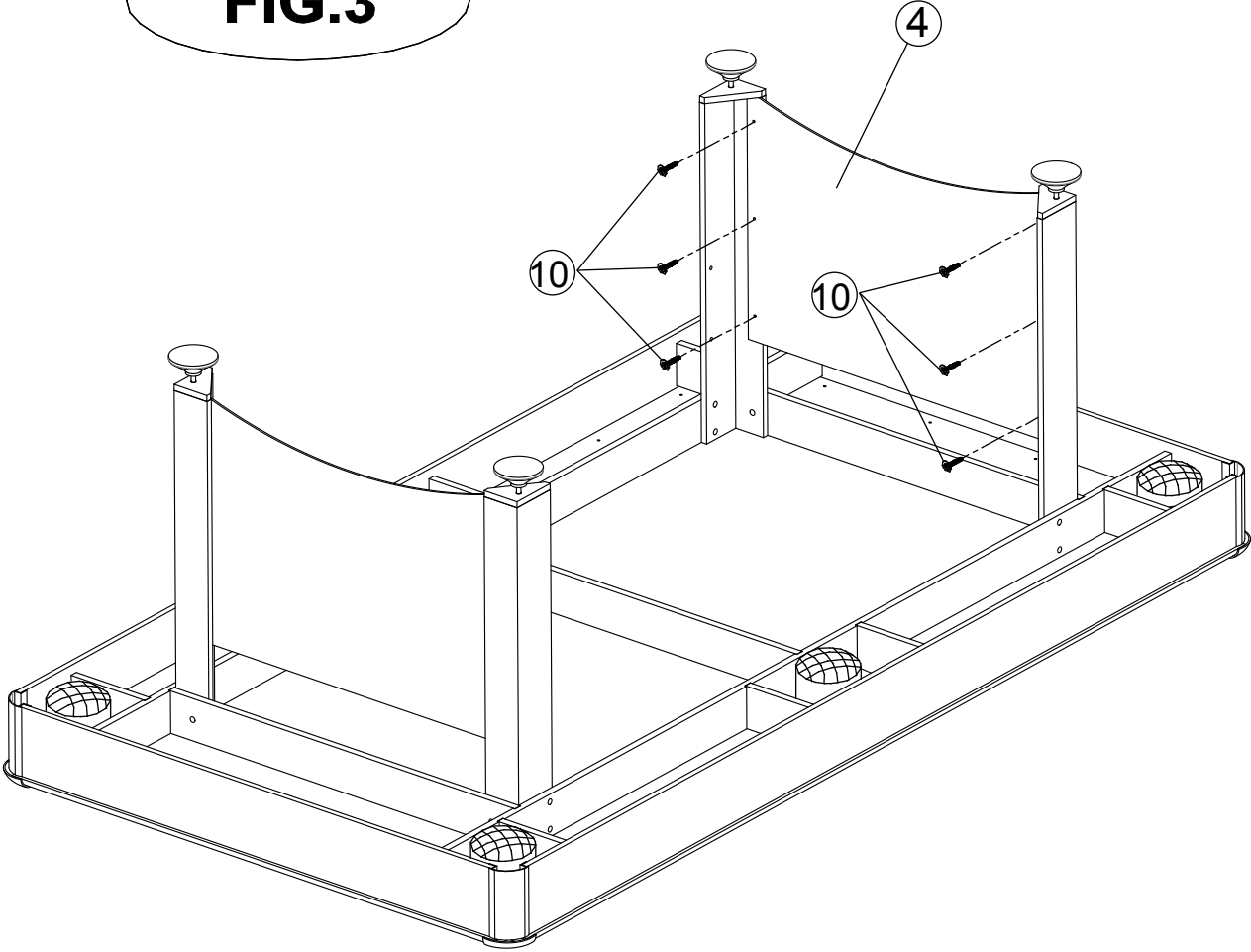

PART REQUIRED:

- 2 pcs - #5 Side Leg Brace
- 8 pcs - #7 Allen Head Bolt
- 8 pcs - #9 Flat Washer
- 1 pc - #29 Allen Wrench

Step 6

Attach Side Leg Braces (#5) to Legs using two of Leg Bolts (#7) and two of Washers (#9) per Leg. See FIG.4.

Use #29 Wrench to tighten all bolts. Remember to tighten all #6 Leg Bolts from STEP 4.

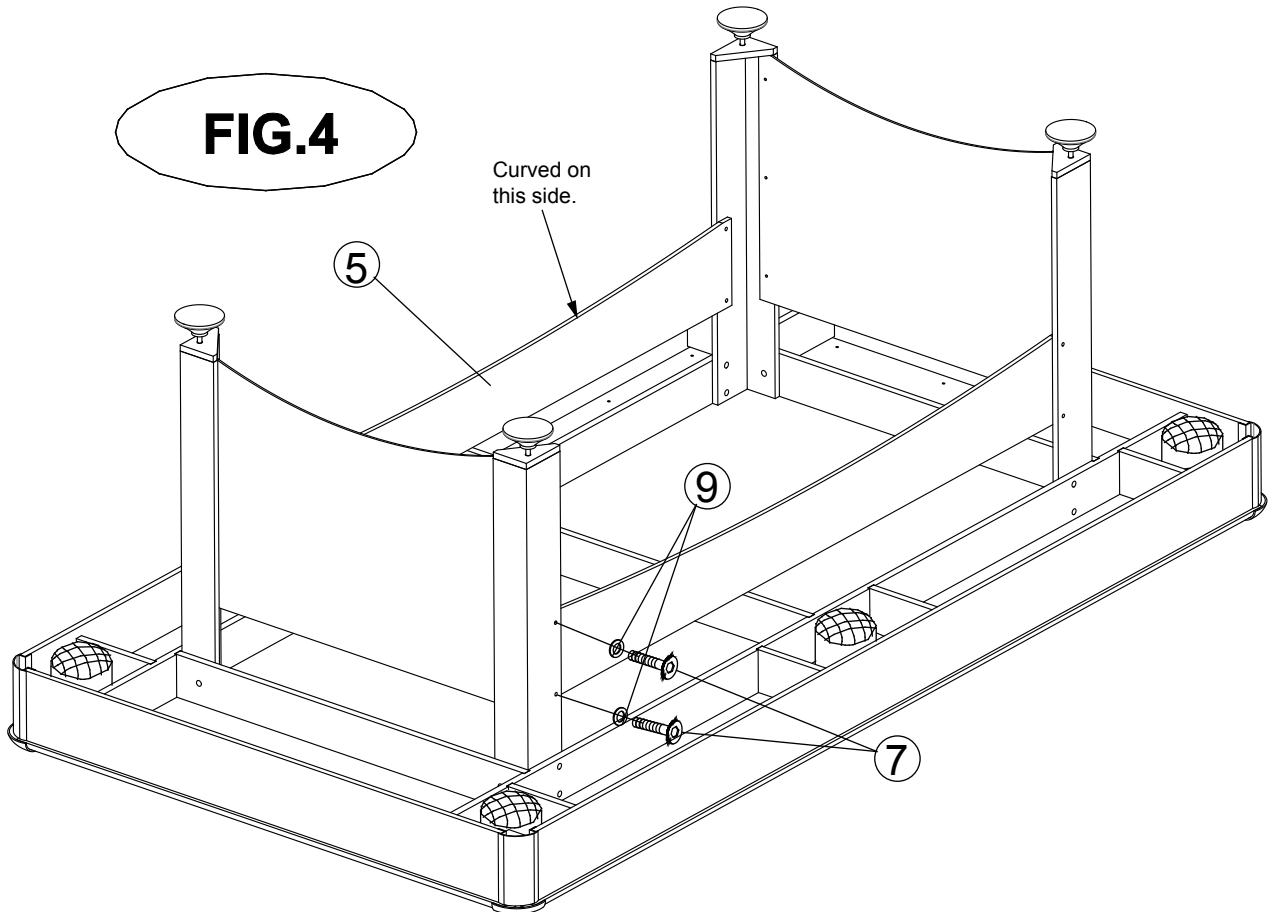

! WARNING:

THIS STEP REQUIRES TWO OR MORE ADULTS.
VERY CAREFULLY TURN THE TABLE OVER AND SET IT ON
ITS LEGS. BE CAREFUL. THE TABLE IS VERY HEAVY.

PARTS REQUIRED:

2 pcs - #11 Table Tennis Support	1 pc - #20 Net
2 pcs - #22 Table Tennis Surface (A)	2 pcs - #21 Net Post
1 pc - #30 Table Tennis Surface (B)	4 pcs - #31 EVA Pad

Step 7

Place the Table Tennis Surface Half (#22 & #30) onto the billiard surface using 2 pcs Table Tennis Supports (#11) Placed Underneath and insert the Net Posts (#21) and Net (#20).

See FIG.5 and 5A.

Place 4 pcs EVA Pad (#31) as shown in FIGURE 5B for Table Tennis Flatness purpose.

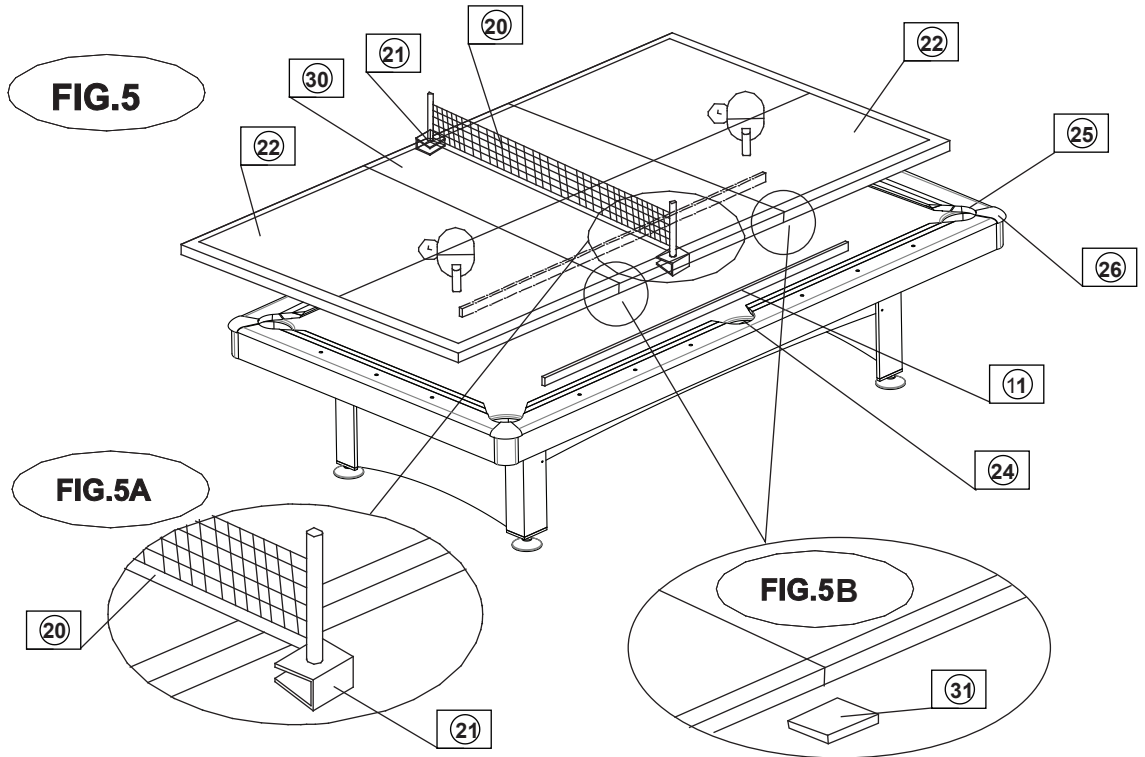

Congratulations! You have now assembled your pool table. Please note the Care and Use instructions below to insure many years of trouble free use of your pool table.

CARE AND USE OF YOUR TABLE

1. Use spray furniture polish to clean all exterior surfaces of your pool table.
2. Use the table brush provided to clean the cloth on the table.
3. This product is intended for **INDOOR** use only.
4. **DO NOT** sit, climb or lean on the table.
5. **DO NOT** drag the table when moving it. This will damage the legs.
6. **DO NOT** set drinks on the table.
7. The purchase of a pool table cover will both protect and help keep clean the entire top of the pool table.

PRODUCT PARTS LIST FOR MODEL # 45-6840

Key #	Part #	Description	Qty.
1	45-6840GR1	Cabinet for Billiard	1
2	45-6840GR2	Left Leg	2
3	45-6840GR3	Right Leg	2
4	45-6840GR4	End Leg Brace	2
5	45-6840GR5	Side Leg Brace	2
6	45-6840GR6	5/16"X1-1/4" Leg Bolt	12
7	45-6840GR7	1/4"x1" Leg Bolt	8
8	45-6840GR8	5/16"×Ø19×1.5 MM Washer	12
9	45-6840GR9	1/4"×Ø15×1 MM Washer	8
10	45-6840GR10	4x12MM Washer Head Screw	12
11	45-6840GR11	Table Tennis Support	2
12	45-6840GR12	Cue Stick	2
13	45-6840GR13	Chalk	1
14	45-6840GR14	Triangle Rack	1
15	45-6840GR15	Billiard Balls Set	1
16	45-6840GR16	Leg Leveler	4
17	45-6840GR17	Brush	1
18	45-6840GR18	Table Tennis Paddle	2
19	45-6840GR19	Table Tennis Ball	2
20	45-6840GR20	Table Tennis Net	1
21	45-6840GR21	Net Post	2
22	45-6840GR22	Table Tennis Surface - A	2
23	45-6840GR23	T-Nut (Pre-installed)	12
24	45-6840GR24	Side Pocket w/ Nail (Pre-installed)	2
25	45-6840GR25	Corner Pocket w/ Nail (Pre-installed)	4
26	45-6840GR26	Top Corner Cap (Pre-installed)	4
27	45-6840GR27	Fabric Pocket (Pre-installed)	6
28	45-6840GR28	Apron Corner (Pre-installed)	4
29	45-6840GR29	Allen Wrench	1
30	45-6840GR30	Table Tennis Surface - B	1
31	45-6840GR31	EVA Pad	4