

Item No. _____
Quantity _____



BEVERAGE-AIR

3779 Champion Blvd., Winston-Salem, NC 27105
1-888-845-9800 Fax# 1-336-245-6453
<http://www.Beverage-Air.com>

CUSTOMER'S CHOICE FOR A *HOT* KITCHEN
Tested & Certified to Ambient Class of 100°F

BOTTOM MOUNTED REACH-IN REFRIGERATORS

Horizon Series
Glass and Half Glass Doors

MODEL:
HBR23-1-G / HBR23-1-HG
HBR27-1-G / HBR27-1-HG
HBR44-1-G / HBR44-1-HG
HBR49-1-G / HBR49-1-HG
HBR49-1-G / HBR49-1-HG
HBR72-1-G / HBR72-1-HG

3 Year Parts/Labor Warranty Additional 2 Year Compressor Warranty

CABINET CONSTRUCTION

- Exterior—Stainless steel interior and exterior standard.
- Insulation—foamed-in-place CFC and HCFC-free polyurethane insulation.
- One-piece grille allows easy removal/installation for preventative maintenance.

ELECTRONIC CONTROL

- Electronic thermostat provides a digital display of cabinet temperatures, which includes status indicators and key pad for any necessary temperature adjustments.

REFRIGERATION SYSTEM

- Bottom mount balanced refrigeration system for better ergonomics.
- Automatic condensate evaporation system for energy efficiency.
- Forced-air system ensures uniform distribution of airflow throughout the entire cabinet for even product temperatures; maintains product temperatures between 36 - 38°F.
- Self-contained refrigeration system uses environmentally friendly (CFC and HCFC-free) R134A refrigerant.

DOORS

- Choose from full glass or half glass door configuration.
- Anti-microbial door handles
- Spring-loaded hinges standard. Positive seal self-closing door(s) with 120° stay open feature.
- Plug-in magnetic door gaskets of one piece construction, removable without tools for ease of cleaning.

SHELVING

- Three (3) heavy duty epoxy coated wire shelves per section standard. Four (4) shelf clips included per shelf (field installed).
- Shelves are adjustable in 1/2" increments.

MODEL FEATURES

- LED lighting option standard
- 6" heavy-duty casters included, two with brakes standard. 3" casters or 6" legs optional.
- Pre-wired plug for 115/60/1 phase.
- Epoxy coated evaporator prevents corrosion.
- UL-EPH and CUL for open food product.



HBR23-1-HG

Available From:



*Note: Not all markings may apply to all model variations.

Model Specified _____

Store# _____

Location _____

Quantity _____



BEVERAGE-AIR

Horizon Bottom Mount Refrigerators

Models: HBR23, HBR27, HBR44, HBR49, HBR72

PLAN VIEWS

| MODEL | HBR23 | HBR27 | HBR44 | HBR49 | HBR72 |
|--|-----------------|-----------------|-----------------|-----------------|-----------------|
| EXTERNAL DIMENSIONAL DATA | | | | | |
| Length Overall (inches) Length Overall (mm) | 27 1/4" 692 | 30" 762 | 47" 1193 | 52" 1321 | 75" 1905 |
| Depth Overall (inches) - includes handle Depth Overall (mm) - includes handle | 33 3/4" 857 | 33 3/4" 857 | 33 3/4" 857 | 33 3/4" 857 | 33 3/4" 857 |
| Height Overall—(inches) / (mm) Add 6" for legs or casters | 78" / 1981 | 78" / 1981 | 78" / 1981 | 78" / 1981 | 78" / 1981 |
| Number of doors | 1 | 1 | 2 | 2 | 3 |
| Depth with Door Open 90 ° | 60" | 60" | 60" | 60" | 60" |
| INTERNAL DIMENSIONAL DATA | | | | | |
| NET Capacity (cubic ft.) NET Capacity (Liters) | 23 651 | 27 765 | 44 1246 | 49 1388 | 72 2039 |
| Internal Length Overall (inches) Internal Length Overall (mm) | 24" 610 | 27" 686 | 47" 1194 | 49" 1245 | 72" 1829 |
| Internal Depth Overall (inches) Internal Depth Overall (mm) | 28 1/2" 724 | 28 1/2" 724 | 28 1/2" 724 | 28 1/2" 724 | 28 1/2" 724 |
| Internal Height Overall—(inches) Internal Height Overall—(mm) | 61 3/4" 1569 | 61 3/4" 1569 | 61 3/4" 1569 | 61 3/4" 1569 | 61 3/4" 1569 |
| Number of shelves | 3 | 3 | 6 | 6 | 9 |
| ELECTRICAL DATA | | | | | |
| Full Load Amperes 115/60/1 | 5.8 A | 5.8 A | 8.8 A | 8.8 A | 9.9 A |
| REFRIGERATION DATA | | | | | |
| Horsepower | 1/3 | 1/3 | 1/3 | 1/3 | 1/2 |
| WEIGHT DATA | | | | | |
| Gross Weight (Crated lbs) | 400 | 400 | 528 | 608 | 771 |
| Gross Weight (Crated kg) | 181 | 181 | 239 | 276 | 350 |

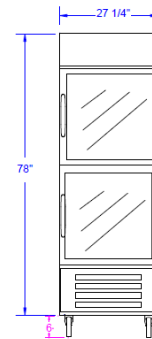

HBR23-1-HG

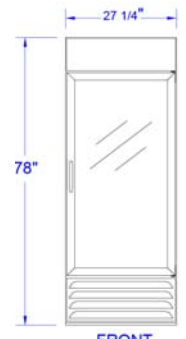

FRONT
HBR23-1-G

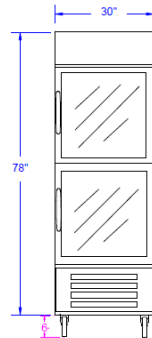

HBR27-1-HG

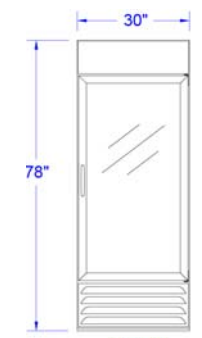

FRONT
HBR27-1-G

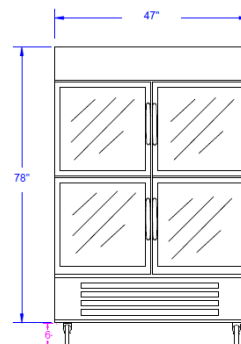

HBR44-1-HG

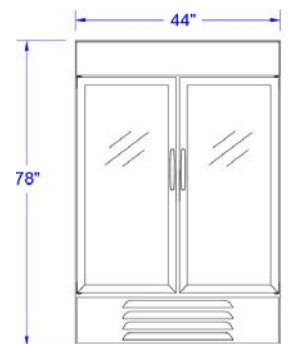

HBR44-1-G



Note: Not all markings may apply to all model variations.

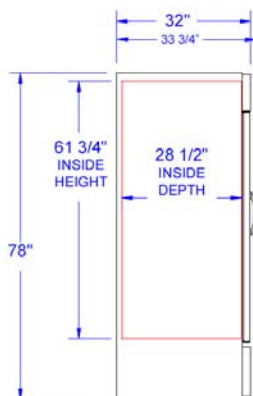

END

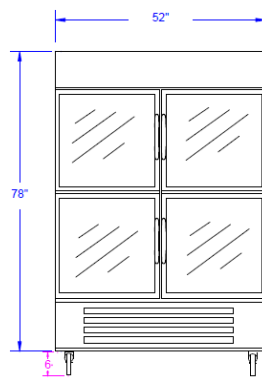

HBR49-1-HG

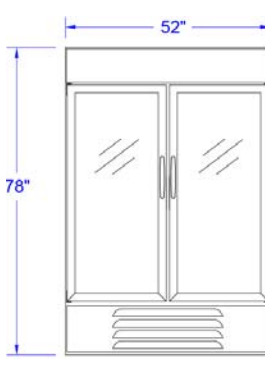

HBR49-1-G

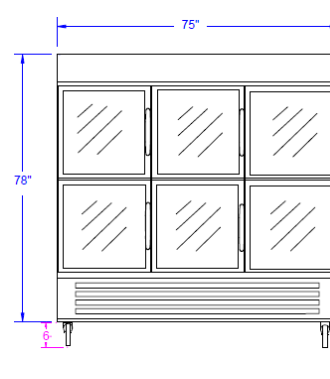

HBR72-HG

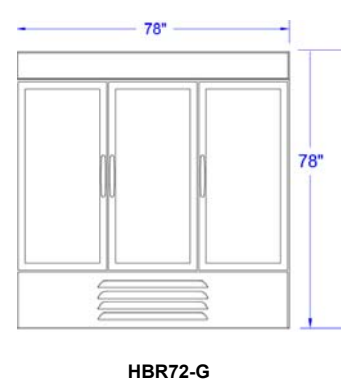

HBR72-G

BEVERAGE-AIR® CORPORATION

3779 Champion Blvd. • Winston-Salem, NC 27105 USA • (336) 245-6400 • Fax (336) 245-6453 • (888) 845-9800 • www.beverage-air.com

Specifications are subject to change without prior notice. 07/16