

C5250 SERIES

SENTRY® EURO ONE-SIZE-FITS-ALL CUP DISPENSER INSTALLATION INSTRUCTIONS

This bag contains: Instruction Sheet, Contamination Guard and Mounting Screws.

1. Cut hole in counter surface.

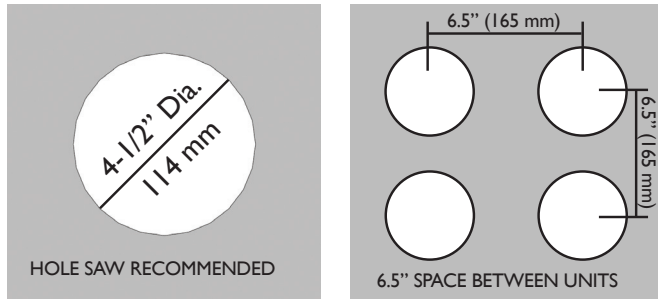

2. Remove cover ring turning counterclockwise.

3. Secure mounting ring to counter with supplied screws.

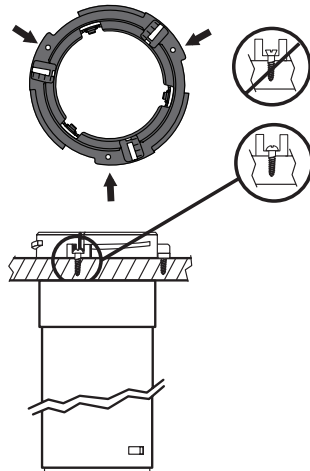

4. Load cups.

5. Move the adjustment levers to assure one-at-a-time dispensing.

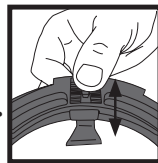

6. Install Contamination Guard over posts in underside of ring.

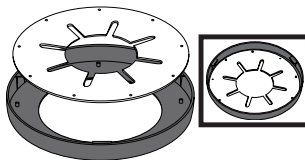

7. Replace cover ring with gasket by turning clockwise over mounting ring until secure.

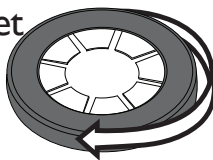

8. TO REFILL DISPENSER: Load cups through contamination guard.

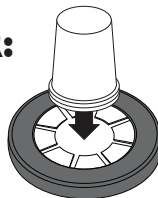

INSTRUCCIONES PARA LA INSTALACION DE EL DISPENSADOR DE VASOS AJUSTABLE

Esta bolsa contiene: Manual de Instrucciones, Protección contra Contaminación tornillos para montaje.

1. Perfore el orificio en el mostrador.

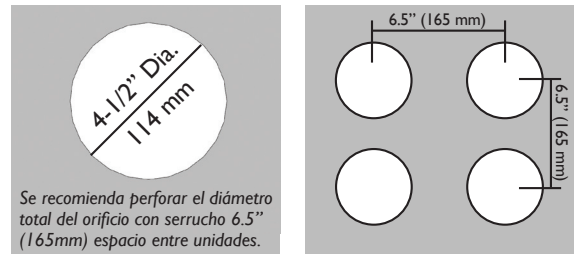

2. Remueva el anillo de cobertura girando en el sentido de las agujas del reloj.

3. Fije el anillo para montar en el mostrador, utilizando tornillos suplidos.

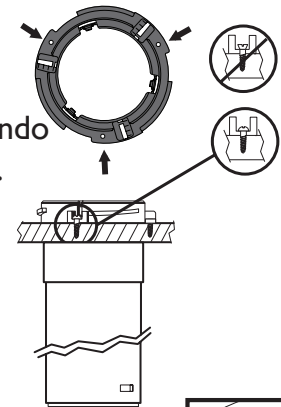

4. Inserte los vasos.

5. Ajuste la palanca para asegurar dispensación una a la vez.

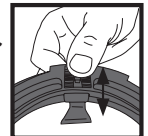

6. Instale la protección contra contaminación sobre el poste y bajo el anillo.

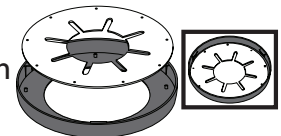

7. Remplace el anillo de cobertura con el gasquete girando en sentido de las agujas del reloj.

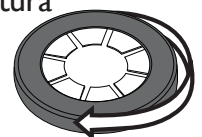

8. PARA CARGAR EL DISPENSADOR: Inserte los vasos a través de la protección contra la contaminación.

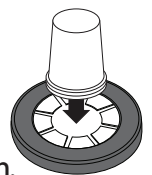

San Jamar
555 Koopman Lane
Elkhorn, Wisconsin 53121
USA
T: +1.262.723.6133
F: +1.262.723.4204
info@Sanjamar.com
www.Sanjamar.com

San Jamar Canada
3300 Bloor Street West
Center Tower, 11th Floor
Suite 3140 Toronto, ON
M8X 2X3
CANADA
T: +1.416.760.7367
F: +1.416.207.2071
canada@Sanjamar.com

San Jamar Europe
Schoorstraat 26a, bus 1
2220 Heist op-den Berg
BELGIUM
T: +32 1522 8140
F: +32 1522 8148
emea@Sanjamar.com

San Jamar México
Av. Universidad #1377-701
Colonia Axotla CP 01030
Del. Alvaro Obregón
MEXICO, D.F.
T: +52 (55) 3626 0772
F: +52 (55) 5273 4495
mexico@Sanjamar.com

 **san jamar®**
smart. safe. sanitary.