



Well Solutions

Cafeterias • Buffets
Convenience Stores • Supermarkets & Delis
Restaurants & Cafés • Clubs & Bars



SW2-11QT with optional upper shelf, backplash and LED lighting in *Designer* color (accessories: cup rail, magnetic graphics, food pans, hinged lids [ladles not available]) *pg. 3*



HW-43 with accessory pan support bars (food pans, ladles and lids not available) *pg. 5*



HCWBI-3DA with accessory food pans *pg. 6*



IWB-6 with accessory food pan with **NLL-60** (sneeze guards and bowls not available) *pg. 7*



CWB-6 with accessory food pans and pan support bars *pg. 10*



FTB-2 with accessory full-size sheet pans *pg. 15*



HWBI-3MA with accessory food pans *pg. 20*



HWBI-2 with accessory pans (sneeze guards not available) *pg. 20*



HWBRT-7QTD and **HWBRT-11QTD** with accessory food pans and mounting kit (also shown **HWBL-43D**, **HWBLI-FULD** and **GR2AHL** with standard *Designer* non-adjustable stands and optional *Designer* color and sneeze guards) *pg. 31, 27, 25*



Round Heated Wells

The multipurpose dry Heated Well from Hatco offers the flexibility of foodwarmers, soup kettles, Bain-Marie heaters, steamers and pasta cookers all in one! With a range of temperature settings, Heat-Max can boil pasta and soup noodles, steam dim sum and warm and hold soups, curry, gravies and toppings at safe serving temperatures.

- Three temperature setpoints from 122°F to 212°F for warming, steaming and boiling
- Low power mode allows energy efficiency
- Single built-in model available (one 11-quart round pan)
- Freestanding units available as a single (one 11-quart round pan) or dual model (two 11-quart round pans) with individually controlled pans



RHW-1B with RHW accessory pan and lid (ladle not included)



RHW-1 with RHW accessory pan and lid



RHW-2 with RHW accessory pans

FREESTANDING ROUND HEATED WELLS

Model	Voltage Single Phase	Dimensions W x D x H	kW	Plugs	Ship Weight
RHW-1	120	14 ¹ / ₈ " x 13" x 14"	1.3	NEMA 5-15P	21 lbs.
RHW-2	208-240	24 ⁷ / ₈ " x 13" x 14"	2.5-2.7	NEMA 6-15P	38 lbs.

All Freestanding Round Heated Well Models Feature:

Liquid Capacity: RHW-1: 11 quart round pan (actual pan capacity: 6³/₄ quarts for boiling application or 8¹/₂ quarts for warming application).

RHW-2: 2 x 11 quart round pans (actual pan capacity: 2 x 6³/₄ quarts for boiling application or 2 x 8¹/₂ quarts for warming application).

RHW-1 Shipped with: One food holding pan and one pan lid.

RHW-2 Shipped with: Two food holding pans and two pan lids.

Cord Location: 72" cord and plug, back of unit.

BUILT-IN ROUND HEATED WELL

Model	Voltage Single Phase	Dimensions W x D x H	kW	Plug	Ship Weight
RHW-1B	120	14 ¹ / ₈ " x 13" x 13 ¹ / ₈ "	1.3	NEMA 5-15P	21 lbs.

All Built-In Round Heated Well Models Feature:

Liquid Capacity: 11 quart round pan (Actual pan capacity: 6³/₄ quarts for boiling application or 8¹/₂ quarts for warming application).

RHW-1B Shipped with: One food holding pan, one pan lid and remote control.

Cord Location: 56" cable from well to control box with a 6' cord and plug located at the back of the control box.

Recommended Well Cut-Out Size: 11¹/₈" diameter.

ACCESSORIES (available for purchase at any time)

- RHW-11QT-LID-HG RHW Hinged Lid for 11-Quart Round Pan
- RHW-11QT-POT RHW 11-Quart Round Pan



RHW-11QT-LID-HG Hinged lid for 11-quart round pan

RHW-11QT-POT 11-quart round pan

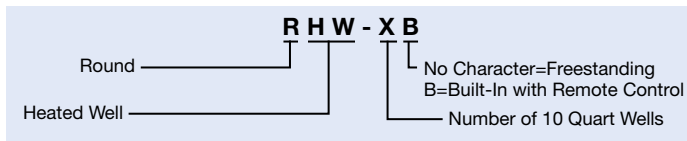

Soup Stations

Hatco's Soup Station is designed to provide an attractive appearance while holding pre-heated soups at safe serving temperatures – whether it's front of the house, self-serve kiosks or catering.

Heat is evenly distributed throughout the unit to hold foods at optimum temperatures, and the insulated stainless steel design provides easy maintenance and durable performance.

- Unit available to accommodate two 7-quart or two 11-quart round pans
- Stainless steel construction with insulation that provides easy maintenance and durable performance
- Infinite switch with indicator light on both ends of unit controls nearest well
- Convenient recessed handles
- Comes with 6' cord and plug attached

SW2-11QT



SOUP STATIONS

Model	Voltage Single Phase	Dimensions W x D x H	Watts	Plug	Ship Weight
SW2-7QT	120	25½" x 15¾" x 10¾"	750	NEMA 5-15P	34 lbs.
SW2-11QT	120	25½" x 15¾" x 10¾"	750	NEMA 5-15P	53 lbs.

All Soup Station Models Feature:

Models Shipped with: Two heating elements, indicator light, infinite switch and controls located at each end of unit.

Cord Location: Back of unit.

OPTIONS (available at time of purchase only)

Designer Color – Non-standard colors are non-returnable – Stainless Steel Standard – SS Base in Stainless Steel

BLACK Base in Designer Black

Upper Shelf with LED Lights (includes a Reversible Back that fits Magnetic Graphics [not included] or reverse for a Sign Holder to insert your custom signage) – Non-standard colors are non-returnable – Stainless Steel Standard –

SW2-US-LED Stainless Steel – add 1" to depth, 16¼" to height

SW2-US-LED-BK Designer Black – add 1" to depth, 16¼" to height

PAN AND LID ACCESSORIES – PAGE 4
COLORS AND FINISHES - PAGE 34

SW2-7QT in optional Designer color



SW2-US-LED (upper shelf with LED lights and reversible back for magnetic graphics or reverse for a sign holder to insert your custom signage)

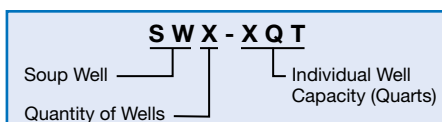

ONE YEAR, ON-SITE PARTS AND LABOR WARRANTY.



Soup Station Accessories (available for purchase at any time)



SW2-11QT in optional *Designer* color with upper shelf and LED lights (includes reversible back)

Accessories shown: Magnetic backsplash graphic, *Designer* color cup rail, magnetic base graphics and pans with lids (ladles not available)

REVERSIBLE BACK – RAIL – GRAPHICS

Reversible Back (fits Magnetic Graphics [not included] or reverse the back for a Sign Holder to insert your custom signage) – Non-standard colors are non-returnable – Stainless Steel Standard –

SW2-BACK	Reversible Back (with Posts) in Stainless Steel – Graphic not included
SW2-BACK-BK	Reversible Back (with Posts) in <i>Designer</i> Black – Graphic not included

Cup Rails –

SW2-4.5RAIL	Cup Rail in Stainless Steel – add 4½" to depth
SW2-4.5RAIL-BK	Cup Rail in <i>Designer</i> Black – add 4½" to depth

Magnetic Graphics (for Base and Reversible Back) –

SW2-BASEGRPHCS	Magnetic Base Graphics (covers 3 sides – front and both sides of Soup Station)
SW2-BACKSGRPHC	Magnetic Backsplash Graphic (Backsplash Graphic Area: 23¼"W x 11⅝"D)

PANS – LIDS

7QT-PAN	7-Quart Round Pan
11QT-PAN	11-Quart Round Pan

Notched Lid for Round Pans –

7QT-LID-1	7-Quart Hinged and Notched Lid
11QT-LID-1	11-Quart Hinged and Notched Lid

Hinged Lid for Round Pans –

7QT-LID	7-Quart Hinged and Notched Lid
11QT-LID	11-Quart Hinged and Notched Lid

COLORS AND FINISHES - PAGE 34



SW2-BACK
Reversible back (with posts) in stainless steel, fits magnetic graphics (not included) or reverse the back for signholder to insert your custom signage



SW2-4.5RAIL
Cup rail accessory



SW2-BASEGRPHCS
Three magnetic base graphic accessories (covers 3 sides of base)

SW2-BACKSGRPHC
Magnetic backplash accessory



Countertop Heated Wells

Providing versatility and reliability, Hatco Countertop Heated Wells hold food hot and fresh in either a wet or dry operation with an adjustable temperature control. The -FUL units can hold a full-size pan or three third-size pans, while the -43 units can hold a full-size pan with a third-size pan or four third-size pans. The HW Series are hold only, while the CHW Series are capable of rethermalizing a variety of foods as well as holding (cook and hold).

- Controls feature a separate lighted On/Off rocker switch and adjustable temperature dial
- May be used dry but best performance when used with water. Dry indicator lamp informs user to add water

- Thicker 1 mm stainless steel pan with a stainless steel housing (aluminized steel bottom)
- Pan edge offset helps keep condensation from dripping onto countertop surface



HW-FUL with accessory food pans and a pan support bar



CHW-43 with accessory food pans and pan support bars (single unit holding 4 third-size pans)

HOLD ONLY COUNTERTOPS – FULL-SIZE AND 4/3-SIZE

Model	Dimensions W x D x H	Voltage	Watts	Plug	Ship Weight
Standard Watt					
HW-FUL	14½" x 24" x 9¾"	120	1200	NEMA 5-15P	29 lbs.
HW-43	14½" x 31" x 9¾"	120	1200	NEMA 5-15P	27 lbs.

COOK & HOLD COUNTERTOPS – FULL-SIZE AND 4/3-SIZE

Model	Dimensions W x D x H	Voltage	Watts	Plug	Ship Weight
High Watt					
CHW-FUL	14½" x 24" x 10¾"	120	1440	NEMA 5-15P	29 lbs.
CHW-43	14½" x 31" x 10¾"	120	1800	NEMA 5-15P*	35 lbs.

* Canadian Models use NEMA 5-20P.

All Countertop Heated Well Models Feature:

Voltage: Single phase only.

Cord Location: Bottom left corner on back of unit.

Models Shipped with: Stainless steel pan, stainless steel (aluminized stainless steel bottom) housing with a metal sheathed heating element, a power On/Off switch, a temperature control, a dry unit indicator light and a 6' cord with plug attached.

ACCESSORIES (available for purchase at any time)

HW-2-7QT	Adapter to convert warmer to hold two 7-Quart Inserts (Models HW-FUL, CHW-FUL only)
HW-3-4QT	Adapter to convert warmer to hold three 4-Quart Inserts (Models HW-FUL, CHW-FUL only)
HW-2-11QT	Adapter to convert warmer to hold two 11-Quart Inserts (Models HW-43, CHW-43 only)
HW12BAR	12" Pan Support for Countertop Wells
HW20BAR	20" Pan Support for Countertop Wells

ADDITIONAL PAN AND LID ACCESSORIES – PAGE 32-33

CHW - XXX

C=Cook/Rethermalizing
No Character=Hold only
Heated Well

FUL = Full Size Pan
43 = 4/3 Size Pan

ONE YEAR, ON-SITE PARTS AND LABOR WARRANTY.



Drop-In Hot/Cold Wells

Whether it is breakfast in the morning or a salad bar at lunch, this well incorporates the legendary Hatco quality of both the hot and cold units into one.

- Accommodates full-size pans
- Similar to our Hatco CWB Refrigerated Well including auto-defrost, easy serviceability, the optimal insulation and efficient condenser
- Utilizes the same time-tested FR2 Hydro-Heater (Bain-Marie) with the "free flow" technology for an efficient and safe operation with a longer life
- Simple controls for ease of use
- Adjustable set points to keep your particular food items at optimum temperatures
- Remote control box that can be mounted to a front counter for easy access (any vertical surface within approximately five feet)



HCWB I-2DA shown in **hot** mode with heated pan support (included), designed for easier handling of food pans



HCWB I-2DA shown in **cold** mode with cold pan support bars (included) and accessory pans

DROP-IN FULL-SIZE INSULATED RECTANGULAR WELLS

Model	Dimensions W x D x H	Watts	Voltage	Phase	Ship Weight [†]
HCWB I-2DA	32" x 27" x 25½"	3000	120/208, 120/240	1 or 3	230 lbs.
HCWB I-3DA	45" x 27" x 25½"	3000	120/208, 120/240	1 or 3	270 lbs.
HCWB I-4DA	58" x 27" x 25½"	4000	120/208, 120/240	1 or 3	310 lbs.
HCWB I-5DA	71" x 27" x 25½"	6000	120/208, 120/240	1 or 3	350 lbs.
HCWB I-6DA	84" x 27" x 25½"	6000	120/208, 120/240	1 or 3	389 lbs.

All Models utilize R-404A Refrigerant.

[†]Shipping weights are approximate.

All Drop-In Full-Size Insulated Rectangular Well Models Feature:

Models Shipped with: Electronic temperature control, pan support bars for full-size pans (one set each: hot and cold mode), Bain-Marie, low-water cut-off (LWCO), condensing unit, auto-defrost, sight glass, service valves and dryer.

OPTIONS (available at time of purchase only)

EWC Additional Four Year Parts Only Warranty on the Compressor

ACCESSORIES (available for purchase at any time)

FR2-FLUSH Flush Hose, Cleaning Brush, Stopper and Adapter

CWB12BAR 12" Pan Support for Drop-In Refrigerated Wells

CWB20BAR 20" Pan Support for Drop-In Refrigerated Wells



ADDITIONAL ACCESSORIES – PAGE 32-33

FR2-FLUSH

DROP-IN HOT/COLD WELLS COUNTERTOP CUT-OUTS

Model	Minimum Width	Maximum Width	Minimum Depth	Maximum Depth
HCWB I-2DA	30½"	31"	25¾"	26"
HCWB I-3DA	43½"	44"	25¾"	26"
HCWB I-4DA	56½"	57"	25¾"	26"
HCWB I-5DA	69½"	70"	25¾"	26"
HCWB I-6DA	82½"	83"	25¾"	26"

H C W B I - X D A

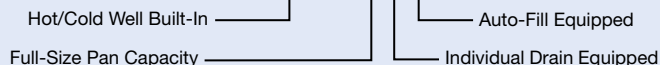

ONE YEAR, ON-SITE PARTS AND LABOR WARRANTY. AN ADDITIONAL FOUR YEAR EXTENDED PARTS ONLY WARRANTY ON THE COMPRESSOR AVAILABLE AT THE TIME OF UNIT PURCHASE.

Drop-In Ice Wells

Hatco Drop-In Ice Wells provide all the quality features of our Refrigerated Drop-Ins, but without any refrigeration or electrical components. These ice-cooled, insulated units can hold pre-chilled food products at preferred serving temperatures. Ideal for salad bars, cold buffets and chilled beverage bars. Pan dividers give you greater flexibility in your variety of featured food products.

- Full-size insulated top mount wells available to hold 1- to 6-pan configurations
- Optimal insulation on sides and bottom to ensure better cold retention and cost savings
- Bezel design allows clear viewing and easy food access
- Larger 1" brass drain with flat screen simplifies cleaning
- False bottom accessory conveniently holds ice above drain for ease of draining
- Matches the Hatco line of wells for a fully integrated look



IWB-2 with slant option **IWB-2SLANT**



IWB-4

DROP-IN INSULATED ICE WELLS

Model	Dimensions W x D x H	Ship Weight
IWB-1	19" x 27" x 12"	48 lbs.
IWB-2	32" x 27" x 12"	60 lbs.
IWB-3	45" x 27" x 12"	82 lbs.
IWB-4	58" x 27" x 12"	94 lbs.
IWB-5	71" x 27" x 12"	110 lbs.
IWB-6	84" x 27" x 12"	110 lbs.

DROP-IN ICE WELL COUNTERTOP CUT-OUTS

Model	Minimum Width	Maximum Width	Minimum Depth	Maximum Depth
IWB-1	17 ¹ / ₈ "	18"	25 ³ / ₁₆ "	26"
IWB-2	30 ⁷ / ₈ "	31"	25 ³ / ₁₆ "	26"
IWB-3	43 ⁷ / ₈ "	44"	25 ³ / ₁₆ "	26"
IWB-4	56 ⁷ / ₈ "	57"	25 ³ / ₁₆ "	26"
IWB-5	69 ⁷ / ₈ "	70"	25 ³ / ₁₆ "	26"
IWB-6	82 ⁷ / ₈ "	83"	25 ³ / ₁₆ "	26"

OPTIONS (available at time of purchase only)

IWB-1SLANT	Slant Option for IWB-1
IWB-2SLANT	Slant Option for IWB-2
IWB-3SLANT	Slant Option for IWB-3
IWB-4SLANT	Slant Option for IWB-4
IWB-5SLANT	Slant Option for IWB-5
IWB-6SLANT	Slant Option for IWB-6

ACCESSORIES – PAGE 8

Slant Option for: IWB-1, -2, -3, -4, -5, -6

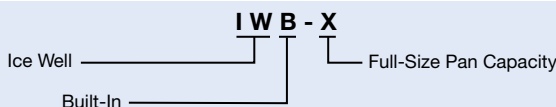
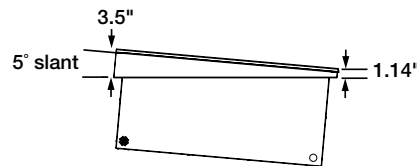

ONE YEAR, ON-SITE PARTS AND LABOR WARRANTY.



Drop-In Ice Well Accessories (available for purchase at any time)



IWB-6
with accessory food pan
(bowls not available)

PANS – TRIVETS

ST PAN 1/3	Third-Size Stainless Steel Pan – 12 $\frac{3}{4}$ "W x 6 $\frac{7}{8}$ "D x 2 $\frac{1}{2}$ "H
ST PAN 1/2	Half-Size Stainless Steel Pan – 12 $\frac{3}{4}$ "W x 10 $\frac{3}{8}$ "D x 2 $\frac{1}{2}$ "H
ST PAN 2	Full-Size Stainless Steel Pan – 12 $\frac{3}{4}$ "W x 20 $\frac{3}{4}$ "D x 2 $\frac{1}{2}$ "H
ST PAN 4	Full-Size Stainless Steel Pan – 12 $\frac{3}{4}$ "W x 20 $\frac{3}{4}$ "D x 4"H
HDW 6" PAN	Full-Size Stainless Steel Pan – 12 $\frac{3}{4}$ "W x 20 $\frac{3}{4}$ "D x 6"H

Wire Trivets Stainless –

TRIVET (1/2)SS	Half-Size – 10 $\frac{1}{6}$ "W x 7 $\frac{3}{8}$ "D
TRIVET SS	Full-Size – 10 $\frac{1}{2}$ "W x 18"D

SUPPORT BARS - FALSE BOTTOMS

Bars –

CWB12BAR	12" Pan Support Bar for Drop-In Ice or Refrigerated Wells
CWB20BAR	20" Pan Support Bar for Drop-In Ice or Refrigerated Wells

False Bottoms (allows for 3 $\frac{1}{2}$ " of ice and sits on ledge of well) –

1FB3.5	For IWB-1 Models (includes one 1-Pan Insert)
2FB3.5	For IWB-2 Models (includes one 2-Pan Insert)
3FB3.5	For IWB-3 Models (includes one 1-Pan Insert and one 2-Pan Insert)
4FB3.5	For IWB-4 Models (includes two 2-Pan Inserts)
5FB3.5	For IWB-5 Models (includes one 1-Pan Insert and two 2-Pan Inserts)
6FB3.5	For IWB-6 Models (includes three 2-Pan Inserts)

False Bottoms (allows for 8" of ice and sits on bottom of well) –

1FB8	For IWB-1 Models (includes one 1-Pan Insert)
2FB8	For IWB-2 Models (includes one 2-Pan Insert)
3FB8	For IWB-3 Models (includes one 1-Pan Insert and one 2-Pan Insert)
4FB8	For IWB-4 Models (includes two 2-Pan Inserts)
5FB8	For IWB-5 Models (includes one 1-Pan Insert and two 2-Pan Inserts)
6FB8	For IWB-6 Models (includes three 2-Pan Inserts)

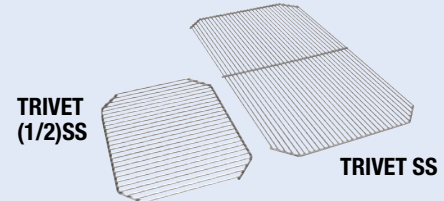

False Bottom Accessories
1-part, 2-part or 3 part(s) depending on pan size

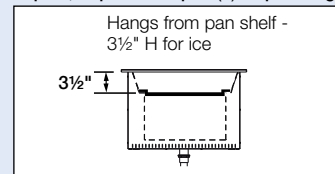

(1, 2, 3, 4, 5 or 6FB3.5) allows (3 $\frac{1}{2}$ ") of ice

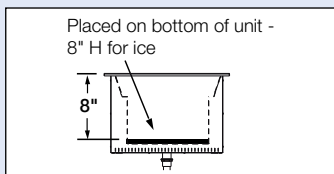

(1, 2, 3, 4, 5 or 6FB8) allows 8" of ice

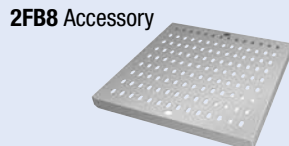

3FB3.5 Accessory

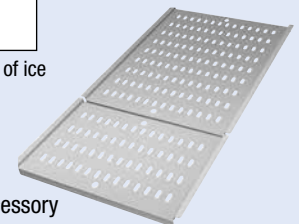

Refrigerated Drop-In Wells Ordering Instructions

Cutaway of **CWB-6** with accessory food pans

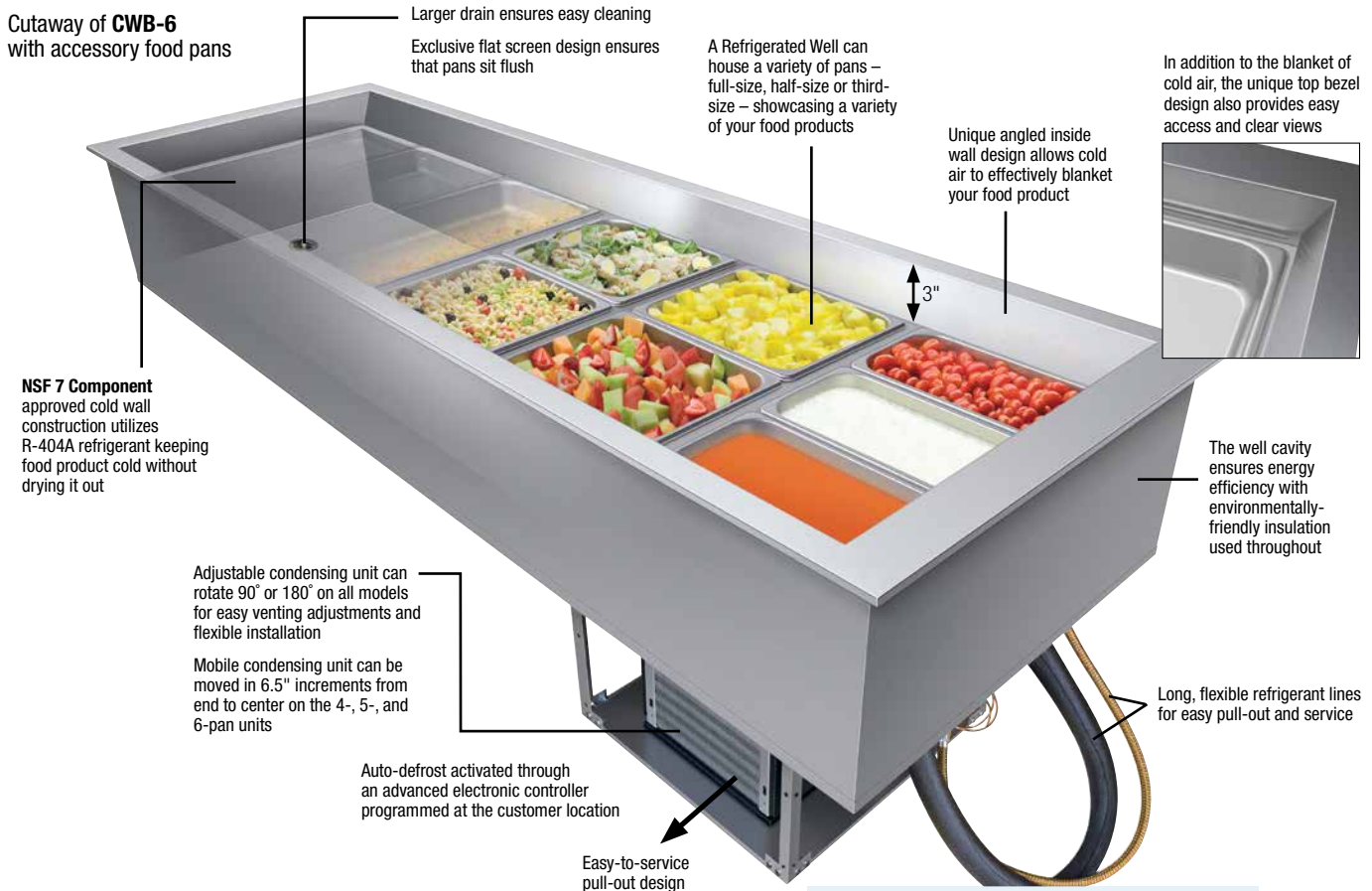

Larger drain ensures easy cleaning
Exclusive flat screen design ensures that pans sit flush

A Refrigerated Well can house a variety of pans – full-size, half-size or third-size – showcasing a variety of your food products

Unique angled inside wall design allows cold air to effectively blanket your food product

In addition to the blanket of cold air, the unique top bezel design also provides easy access and clear views

NSF 7 Component approved cold wall construction utilizes R-404A refrigerant keeping food product cold without drying it out

Adjustable condensing unit can rotate 90° or 180° on all models for easy venting adjustments and flexible installation

Mobile condensing unit can be moved in 6.5" increments from end to center on the 4-, 5-, and 6-pan units

Auto-defrost activated through an advanced electronic controller programmed at the customer location

Easy-to-service pull-out design

The well cavity ensures energy efficiency with environmentally-friendly insulation used throughout

Long, flexible refrigerant lines for easy pull-out and service

Please specify the following with each order:

- Number of Drop-In Wells Required:**
1-, 2-, 3-, 4-, 5- or 6-pan as rectangular, full-size 12" x 20"
- Agency** – UL, C-UL, NSF 7 Component
- Electronic Control Assembly** can be mounted on either side of the Condensing Unit or remotely mounted up to 4 feet from the unit (cannot be mounted over the Condensing Unit)

Option

- Additional Four Year Parts Only Warranty on the Compressor Available at the Time of Unit Purchase
- Slant Option for CWB-1, -2, -3, -4, -5, -6

Accessories

- Pan Support Bars:** 12" or 20"
- Stainless Steel Pans:**
 - Third-size
12³/₄"W x 6⁷/₈"D x 2¹/₂"H
 - Half-size
12³/₄"W x 10³/₈"D x 2¹/₂"H
 - Full-size at 2¹/₂" deep
12³/₄"W x 20³/₄"D x 2¹/₂"H
 - Full-size at 4" deep
12³/₄"W x 20³/₄"D x 4"H
 - Full-size at 6" deep
12³/₄"W x 20³/₄"D x 6"H
- Perforated False Bottom**

From below, you can see the condenser unit after being pulled out by the technician, allowing easy access and visibility to all service components



The sight glass gives an inside look into a usually closed system to determine if the refrigerant is low or if there is water in the system

ACCESSORIES – PAGE 13

REFRIGERATED DROP-IN WELLS COUNTERTOP CUT-OUTS

Model	Minimum Width	Maximum Width	Minimum Depth	Maximum Depth
CWB-1	17 ¹ / ₈ "	18"	25 ⁷ / ₁₆ "	26"
CWB-2	30 ¹ / ₈ "	31"	25 ⁷ / ₁₆ "	26"
CWB-3	43 ¹ / ₈ "	44"	25 ⁷ / ₁₆ "	26"
CWB-4	56 ¹ / ₈ "	57"	25 ⁷ / ₁₆ "	26"
CWB-5	69 ¹ / ₈ "	70"	25 ⁷ / ₁₆ "	26"
CWB-6	82 ¹ / ₈ "	83"	25 ⁷ / ₁₆ "	26"





Refrigerated Drop-In Wells

Hatco's Refrigerated Drop-In Well is a full-size unit that blankets your pre-chilled food product to retain optimum freshness and taste in one efficient and easy operation – a winner for your foodservice operation.

- Full-size, insulated wells available in 1- to 6-pan configurations
- NSF 7 Component approved cold wall construction utilizes R-404A refrigerant keeping food cold without drying it out
- Electronic control assembly can be mounted on either side of the condensing unit or remotely mounted up to 4 feet
- Adjustable condensing unit can be rotated 90° or 180° on all models for easy venting and flexibility at installation
- Mobile condensing unit may be moved in 6.5" increments between the center line and the factory-installed compressor location in the 4-, 5- and 6-pan units
- Auto-defrost is activated through an advanced electronic controller programmed at the customer location
- Optimal insulation on sides and bottom to ensure better cold retention. Environmentally-friendly insulation used throughout
- Easy serviceability with a sight glass, service valves, dryer and a receiver. Long, flexible refrigerant line (ability to pullout condensing unit) for service
- 1" NPT drain simplifies cleaning



CWB-6 with accessory food pans and pan support bars



CWB-2 with slant option CWB-2SLANT

DROP-IN FULL-SIZE INSULATED RECTANGULAR WELLS

Model	HP	Dimensions		Watts	Plug	Ship Weight
		W x D x H				
CWB-1	¼	19" x 27" x 25½"		804	NEMA 5-15P	133 lbs.
CWB-2	¼	32" x 27" x 25½"		804	NEMA 5-15P	175 lbs.
CWB-3	¼	45" x 27" x 25½"		804	NEMA 5-15P	213 lbs.
CWB-4	½	58" x 27" x 25½"		1044	NEMA 5-15P	235 lbs.
CWB-5	½	71" x 27" x 25½"		1380	NEMA 5-15P	270 lbs.
CWB-6	½	84" x 27" x 25½"		1380	NEMA 5-15P	313 lbs.

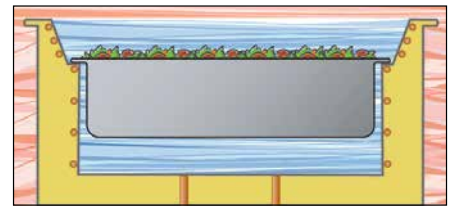

From inside the cavity, the beveled edge allows cold air to effectively blanket your food product

All Drop-In Full-Size Insulated Rectangular Wells Feature:

Voltage: 120V, single phase only.

Models Shipped with: Electronic temperature control, pan support bars for full-size pans, condensing unit (can be rotated), auto-defrost, sight glass, service valves and dryer.

OPTIONS (available at time of purchase only)

EWC	Additional Four Year Parts Only Warranty on the Compressor
CWB-1SLANT	Slant Option for CWB-1
CWB-2SLANT	Slant Option for CWB-2
CWB-3SLANT	Slant Option for CWB-3
CWB-4SLANT	Slant Option for CWB-4
CWB-5SLANT	Slant Option for CWB-5
CWB-6SLANT	Slant Option for CWB-6

COUNTERTOP CUT-OUT DIMENSIONS – PAGE 9
ACCESSORIES – PAGE 13

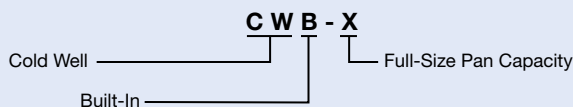
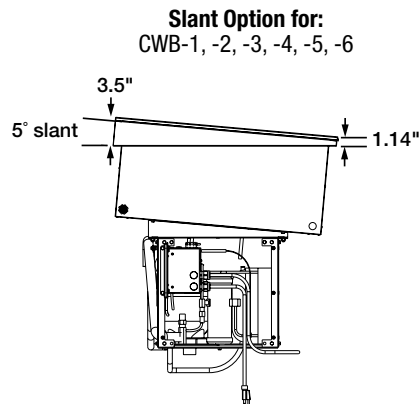

ONE YEAR, ON-SITE PARTS AND LABOR WARRANTY. AN ADDITIONAL FOUR YEAR PARTS ONLY WARRANTY ON THE COMPRESSOR IS AVAILABLE AT THE TIME OF UNIT PURCHASE.

Remote Refrigerated Drop-In Wells Ordering Instructions

Cutaway of **CWBX-6**
with accessory food pans

Cold Well with:
Temperature Probe

Larger drain ensures easy cleaning
Exclusive flat screen design ensures
that pans sit flush

A Refrigerated Well can
house a variety of pans –
full-size, half-size or third-
size – showcasing a variety
of your food products

In addition to the blanket of
cold air, the unique top bezel
design also provides easy
access and clear views

Unique angled inside
wall design allows cold
air to effectively blanket
your food product

NSF 7 Component
approved cold wall
construction utilizes
R-404A refrigerant keeping
food product cold without
drying it out

Auto-defrost
activated through
an advanced
electronic controller
programmed at the
customer location



CWBR: with a Condensing Unit
CWBX: without a Condensing Unit

Option

1. Additional Four Year Parts Only
Warranty on the Compressor Available at the
Time of Unit Purchase (CWBR only)
2. Slant Option for CWBR- and CWBX-1, -2, -3, -4,
-5, and -6

Accessories

1. Pan Support Bars: 12" or 20"
2. Stainless Steel Pans:
 - A. Third-size at 2½" deep
12¾"W x 6⅞"D x 2½"H
 - B. Half-size at 2½" deep
12¾"W x 10⅜"D x 2½"H
 - C. Full-size at 2½" deep
12¾"W x 20¾"D x 2½"H
 - D. Full-size at 4" deep
12¾"W x 20¾"D x 4"H
 - E. Full-size at 6" deep
12¾"W x 20¾"D x 6"H
3. Perforated False Bottom
4. Trivets:
 - A. Half-size
10⅞"W x 7⅞"D
 - B. Full-size
10⅞"W x 18"D

Please specify the following with each order:

1. Number of Drop-In Wells Required:
1-, 2-, 3-, 4-, 5- or 6-pan as rectangular,
full-size, 12" x 20"
2. Remote Refrigeration
NOTE: Shipped loose: Cold Well
with Temperature Probe, Control Panel
(probe wires are 16') and a TXV valve
 - A. CWBR with a condensing unit – may be field
mounted up to 50' of tubing from the unit –
that is shipped loose
 - B. CWBX without a condensing unit
(Solenoid Valve attached to Cold Well)
3. Agency – UL, C-UL, NSF 7 Component (CWBR
units UL, C-UL only)

ACCESSORIES – PAGE 13

REMOTE REFRIGERATED DROP-IN WELLS COUNTERTOP CUT-OUTS

Model	Minimum Width	Maximum Width	Minimum Depth	Maximum Depth
CWBR-1, CWBX-1	17⅞"	18"	25⅜"	26"
CWBR-2, CWBX-2	30⅞"	31"	25⅜"	26"
CWBR-3, CWBX-3	43⅞"	44"	25⅜"	26"
CWBR-4, CWBX-4	56⅞"	57"	25⅜"	26"
CWBR-5, CWBX-5	69⅞"	70"	25⅜"	26"
CWBR-6, CWBX-6	82⅞"	83"	25⅜"	26"





Remote Refrigerated Drop-In Wells

Hatco's Remote Refrigerated Drop-In Wells keep pre-chilled food products at safe serving temperatures but in a remote configuration that offers unlimited flexibility for your own particular dining design needs.



Control panel and a condensing unit (shipped loose)



CWBR-6 with accessory food pans and pan support bars



CWBX-6 with accessory food pans and pan support bars

Control panel (shipped loose)



- Full-size, insulated wells available in 1- to 6-pan configurations
- NSF 7 Component approved cold wall construction utilizes R-404A refrigerant keeping food cold without drying it out
- Optimal insulation on sides and bottom to ensure better cold retention. Environmentally-friendly insulation used throughout
- CWBR models include a condensing unit (shipped loose, can be field mounted up to 50 feet of tubing from unit) and control panel (shipped loose - probe wires are 16 feet) for installing in more convenient or desirable locations
- CWBX model include a control panel (shipped loose - probe wires are 16 feet) but without a condensing unit for the increased flexibility of multiple cold well configurations
- Easy serviceability with a sight glass, service valves, dryer and a receiver (CWBR models only)
- Auto-defrost is activated through an advanced electronic controller programmed at the customer location
- 1" NPT drain simplifies cleaning

REMOTE DROP-IN FULL-SIZE WELLS – WITH CONDENSING UNIT AND REMOTE CONTROL PANEL

Model	HP	Dimensions W x D x H	Ship Weight
CWBR-1	1/4	19" x 27" x 12"	131 lbs.
CWBR-2	1/4	32" x 27" x 12"	160 lbs.
CWBR-3	1/4	45" x 27" x 12"	213 lbs.
CWBR-4	1/3	58" x 27" x 12"	235 lbs.
CWBR-5	1/2	71" x 27" x 12"	271 lbs.
CWBR-6	1/2	84" x 27" x 12"	313 lbs.

All Models utilize R-404A Refrigerant.

All Remote Drop-In Full-Size Well Models with Condensing Unit and Remote Control Panel Feature:

Voltage: CWBR-1, -2, -3: 120V, 804 watts, single phase only.

CWBR-4: 120V, 1044 watts, single phase only.

CWBR-5, -6: 120V, 1380 watts, single phase only.

Models Shipped with: Electronic temperature control, condensing unit and TXV valve (all shipped loose).

PARTS ONLY GUARANTEED FOR ONE YEAR. AN ADDITIONAL FOUR YEAR PARTS ONLY WARRANTY ON THE COMPRESSOR AVAILABLE AT THE TIME OF UNIT PURCHASE.

REMOTE DROP-IN FULL-SIZE WELLS – WITH REMOTE CONTROL PANEL

Model	Dimensions W x D x H	Ship Weight
CWBX-1	19" x 27" x 17 1/16"	80 lbs.
CWBX-2	32" x 27" x 17 1/16"	123 lbs.
CWBX-3	45" x 27" x 17 1/16"	150 lbs.
CWBX-4	58" x 27" x 17 1/16"	176 lbs.
CWBX-5	71" x 27" x 17 1/16"	211 lbs.
CWBX-6	84" x 27" x 17 1/16"	250 lbs.

All Models utilize R-404A Refrigerant.

All Remote Drop-In Full-Size Well Models with Remote Control Panel Feature:

Load: CWBX-1: 330 BTU/Hour.

CWBX-2: 630 BTU/Hour.

CWBX-3: 930 BTU/Hour.

CWBX-4: 1230 BTU/Hour.

CWBX-5: 1530 BTU/Hour.

CWBX-6: 1830 BTU/Hour.

Models Shipped with: Electronic temperature control, TXV valve (shipped loose) and a solenoid valve attached to well.

PARTS ONLY GUARANTEED FOR ONE YEAR.

OPTIONS (available at time of purchase only)

Code	Description
EWC	Additional Four Year Parts Only Warranty on the Compressor (CWBR only)
CWBR-1SLANT	Slant Option for CWBR-1, CWBX-1
CWBR-2SLANT	Slant Option for CWBR-2, CWBX-2
CWBR-3SLANT	Slant Option for CWBR-3, CWBX-3
CWBR-4SLANT	Slant Option for CWBR-4, CWBX-4
CWBR-5SLANT	Slant Option for CWBR-5, CWBX-5
CWBR-6SLANT	Slant Option for CWBR-6, CWBX-6



COUNTERTOP CUT-OUT DIMENSIONS – PAGE 11
ACCESSORIES – PAGE 13

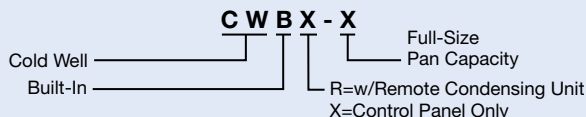

Refrigerated Drop-In Well Accessories *(available for purchase at any time)*



CWB-2 with optional CWB-2SLANT and accessory pans and pan supports (also shown SGCP-42)



PANS – TRIVETS

ST PAN 1/3	Third-Size Stainless Steel Pan – 12 $\frac{3}{4}$ "W x 6 $\frac{7}{8}$ "D x 2 $\frac{1}{2}$ "H
ST PAN 1/2	Half-Size Stainless Steel Pan – 12 $\frac{3}{4}$ "W x 10 $\frac{3}{8}$ "D x 2 $\frac{1}{2}$ "H
ST PAN 2	Full-Size Stainless Steel Pan – 12 $\frac{3}{4}$ "W x 20 $\frac{3}{4}$ "D x 2 $\frac{1}{2}$ "H
ST PAN 4	Full-Size Stainless Steel Pan – 12 $\frac{3}{4}$ "W x 20 $\frac{3}{4}$ "D x 4"H
HDW 6" PAN	Full-Size Stainless Steel Pan – 12 $\frac{3}{4}$ "W x 20 $\frac{3}{4}$ "D x 6"H

Wire Trivets Stainless –

TRIVET (1/2)SS	Half-Size – 10 $\frac{1}{16}$ "W x 7 $\frac{7}{8}$ "D
TRIVET SS	Full-Size – 10 $\frac{1}{8}$ "W x 18"D

SUPPORT BARS – FALSE BOTTOMS

CWB12BAR	12" Pan Support Bar for Drop-In Ice or Refrigerated Wells
CWB20BAR	20" Pan Support Bar for Drop-In Ice or Refrigerated Wells

False Bottom for Drop-In Refrigerated Wells (Perforated False Bottom Accessory, choose your appropriate Pan Size) –

CWB-1FB	For CWB-1 (1-Part Accessory)
CWB-2FB	For CWB-2 (1-Part Accessory)
CWB-3FB	For CWB-3 (2-Part Accessory)
CWB-4FB	For CWB-4 (2-Part Accessory)
CWB-5FB	For CWB-5 (3-Part Accessory)
CWB-6FB	For CWB-6 (3-Part Accessory)

HDW 6" PAN



Support Bars

Choose the appropriate kit for CWB or IBW series



TRIVET (1/2)SS

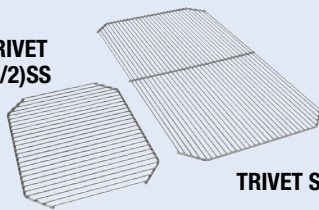

TRIVET SS

CWB-3FB

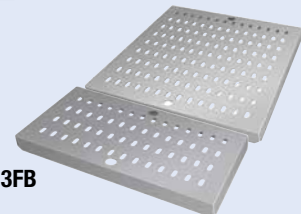



Drop-In Frost Top Ordering Instructions

Cutaway of **FTB-3**
with accessory sheet pans

NSF 7 Component approved, utilizes
R-404A refrigerant keeping food product
cold without drying it out



Please specify the following with each order:

- Number of Full-Size Sheet Pans Accommodated:**
1-, 2- or 3-pan as rectangular sheet pans with a Slim or Standard configuration
- Depth of Model:** Standard configuration (28¹⁵/₁₆"D) or Slim Series (21¹/₁₆"D)
- Drain** – 1" NPT Drain for FTB-2, FTB-3, FTB-S2, FTB-S3 only (drain plumbing to be installed per local codes)
- Agency** – UL, C-UL, NSF 7 Component
- Electronic Control Assembly** can be mounted on either side of the condensing unit or remotely mounted up to 4 feet from the unit (cannot be mounted over the condensing unit)

Option

- Additional Four Year Parts Only Warranty on the Compressor Available at the Time of Unit Purchase

Accessories

- Pans** –
 - Half-size sheet pan
18"W x 13"D
 - Full-size sheet pan
18"W x 26"D

From below, you can see the condenser unit after being pulled out by the technician, allowing easy access and visibility to all service components



The sight glass gives an inside look into a usually closed system to determine if the refrigerant is low or if there is water in the system

DROP-IN FROST TOP COUNTERTOP CUT-OUTS

Model	Minimum Width	Maximum Width	Minimum Depth	Maximum Depth
FTB-1	19 ¹ / ₁₆ "	20 ¹ / ₈ "	27 ⁷ / ₁₆ "	28"
FTB-2	37 ³ / ₈ "	38"	27 ⁵ / ₁₆ "	28"
FTB-3	55 ⁵ / ₁₆ "	56"	27 ⁵ / ₁₆ "	28"
FTB-S2	53 ⁵ / ₁₆ "	54"	19 ⁷ / ₁₆ "	20 ¹ / ₈ "
FTB-S3	79 ¹ / ₁₆ "	79 ⁵ / ₁₆ "	19 ⁷ / ₁₆ "	20 ¹ / ₈ "

Drop-In Frost Tops

Convenience meets style with the Hatco Drop-In Frost Tops. Perfect for quick turn products on self-serve buffets. Ideal for snacks, hors d'oeuvre, side dishes, desserts ... truly a unit for breakfast, lunch and dinner. Sturdy construction and easy clean-up while keeping things cool. Also available in a Slim Line Series, providing wider access to your food product.

- Accommodates full-size sheet pans
- Units include a 1" NPT drain (excluding FTB-1) and refrigeration system
- Electronic adjustable temperature control can be mounted to either side of the condensing unit or remotely up to four feet from unit
- The condensing unit, mounted on the center of the unit, rotates 90° or 180°
- Mobile condensing unit may be moved in 6.5" increments from end to center in the FTB-3, FTB-S2, -S3 units and 3" increments from end to center in the FTB-2
- Optimal insulation on sides and bottom to ensure better cold retention and built with one of the most efficient condensing units on the market
- Auto-defrost is activated through an advanced electronic controller programmed at the customer location



FTB-2 with accessory sheet pans



FTB-S2 with accessory sheet pans

DROP-IN FROST TOPS

Model	Dimensions W x D x H	Watts	Plug	Ship Weight†
FTB-1	21 ¹ / ₁₆ " x 28 ¹⁵ / ₁₆ " x 17 ¹ / ₄ "	804	NEMA 5-15P	132 lbs.
FTB-2	39" x 28 ¹⁵ / ₁₆ " x 17 ¹ / ₄ "	804	NEMA 5-15P	180 lbs.
FTB-3	57" x 28 ¹⁵ / ₁₆ " x 17 ¹ / ₄ "	804	NEMA 5-15P	213 lbs.
Slim				
FTB-S2	54 ¹⁵ / ₁₆ " x 21 ¹ / ₁₆ " x 17 ¹ / ₄ "	804	NEMA 5-15P	182 lbs.
FTB-S3	80 ³ / ₁₆ " x 21 ¹ / ₁₆ " x 17 ¹ / ₄ "	804	NEMA 5-15P	239 lbs.

† Shipping weights are approximate.

All Drop-In Frost Top Models Feature:

Voltage: 120V, single phase only.

Models Shipped with: Electronic temperature control, condensing unit, compressor and flexible refrigerant lines to bottom of unit.

OPTIONS (available at time of purchase only)

EWC Additional Four Year Parts Only Warranty on the Compressor

ACCESSORIES (available for purchase at any time)

ALUM PAN Half-Size Sheet Pan – 18"W x 13"D
18" SHEET PAN Full-Size Sheet Pan – 18"W x 26"D

COUNTERTOP CUT-OUT DIMENSIONS – PAGE 14

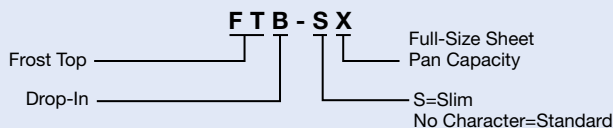

ONE YEAR, ON-SITE PARTS AND LABOR WARRANTY. AN ADDITIONAL FOUR YEAR EXTENDED PARTS ONLY WARRANTY ON THE COMPRESSOR AVAILABLE AT THE TIME OF UNIT PURCHASE.



Remote Drop-In Frost Top Ordering Instructions

Cutaway of **FTBX-3**
with accessory sheet pans

Frost Top with:
Temperature Probe

1" NPT Drain simplifies
cleaning and flat drain
strainer ensures pans
sit flush

Recessed walls designed to
prevent food pan slippage

Control Panel



Auto-defrost activated
through an advanced
electronic controller
programmed at the
customer location



FTBR: Condensing Unit
FTBX: No Condensing Unit

Environmentally-
friendly insulation
used throughout

NSF 7 Component approved cold
wall construction utilizes R-404A
refrigerant keeping food product cold
without drying it out

Please specify the following with each order:

1. Number of Full-Size Sheet Pans Accommodated:

1-, 2- or 3-pan as rectangular sheet pans

2. Depth of Model: Standard configuration (28¹⁵/₁₆"D)

or Slim Series (21¹/₁₆"D)

3. Remote Refrigeration

Note: Shipped loose: Frost Top, Control Panel

(Probe wires are 16 feet) and a TXV valve

A. FTBX without a condensing unit

(Solenoid Valve attached to Frost Top)

4. Agency – UL, C-UL, NSF 7 Component

Accessories

1. Pans –

A. Half-size sheet pan

18"W x 13"D

B. Full-size sheet pan

18"W x 26"D

REMOTE DROP-IN FROST TOP COUNTERTOP CUT-OUTS

Model	Minimum Width	Maximum Width	Minimum Depth	Maximum Depth
FTBR-1, FTBX-1	27 ⁷ / ₁₆ "	28"	19 ⁷ / ₁₆ "	20 ¹ / ₈ "
FTBR-2, FTBX-2	37 ³ / ₈ "	38"	27 ³ / ₁₆ "	28"
FTBR-3, FTBX-3	55 ³ / ₈ "	56"	27 ³ / ₁₆ "	28"
FTBR-S2, FTBX-S2	53 ³ / ₁₆ "	54"	19 ⁷ / ₁₆ "	20 ¹ / ₈ "
FTBR-S3, FTBX-S3	79 ³ / ₁₆ "	79 ³ / ₈ "	19 ⁷ / ₁₆ "	20 ¹ / ₈ "



Remote Drop-In Frost Tops

Keeping pre-chilled beverages, snacks, hors d'oeuvres and side dishes cool and ready-to-serve, the Hatco Remote Drop-In Frost Tops offer additional flexibility with remote configurations. Also available in a Slim Line Series, providing wider access to your customer.

- Accommodates full-size sheet pans
- Units include a 1" NPT drain (excluding FTBR-1 and FTBX-1) and refrigeration system
- FTBR models include a condensing unit (shipped loose, can be field mounted up to 50 feet of tubing from unit) and a control panel (shipped loose - probe wires are 16 feet) for installing in more convenient or desirable locations
- FTBX models include a control panel (shipped loose - probe wires are 16 feet) but shipped without a condensing unit for the increased flexibility of multiple Frost Top configurations
- Easy serviceability with a sight glass, service valves, dryer and a receiver (FTBR models only)
- Auto-defrost is activated through an advanced electronic controller programmed at the customer location (FTBR models only)
- Optimal insulation on sides and bottom to ensure better cold retention and built with one of the most efficient condensing units on the market

FTBR-S2
with accessory
sheet pans



Frost Top
with a
temperature
probe ...



control panel and
a condensing unit
(both shipped loose)



FTBX-S2 with accessory
sheet pans (shipped
without condensing unit)



Control panel
(shipped loose)



REMOTE DROP-IN FROST TOPS – WITH CONDENSING UNIT AND CONTROL PANEL

Model	Dimensions	Ship Weight†
	W x D x H	
FTBR-1	28 ¹⁵ / ₁₆ " x 21 ¹ / ₁₆ " x 3 ³ / ₁₆ "	125 lbs.
FTBR-2	39" x 28 ¹⁵ / ₁₆ " x 3 ³ / ₁₆ "	171 lbs.
FTBR-3	57" x 28 ¹⁵ / ₁₆ " x 3 ³ / ₁₆ "	213 lbs.
Slim		
FTBR-S2	54 ¹⁵ / ₁₆ " x 21 ¹ / ₁₆ " x 3 ³ / ₁₆ "	179 lbs.
FTBR-S3	80 ¹³ / ₁₆ " x 21 ¹ / ₁₆ " x 3 ³ / ₁₆ "	230 lbs.

All Models utilize R-404A Refrigerant.

† Shipping weights are approximate.

All Remote Drop-In Frost Top Models with Condensing Unit and Control Panel Feature:

Voltage – FTBR-1, -2, -3, -S2, -S3: 120V, 804 watts, single phase only.

Models Shipped with: Electronic temperature control, condensing unit and TXV valve (all shipped loose).

REMOTE DROP-IN FROST TOPS – WITH CONTROL PANEL

Model	Dimensions	Ship Weight†
	W x D x H	
FTBX-1	28 ¹⁵ / ₁₆ " x 21 ¹ / ₁₆ " x 8 ⁵ / ₈ "	85 lbs.
FTBX-2	39" x 28 ¹⁵ / ₁₆ " x 8 ⁵ / ₈ "	138 lbs.
FTBX-3	57" x 28 ¹⁵ / ₁₆ " x 8 ⁵ / ₈ "	155 lbs.
Slim		
FTBX-S2	54 ¹⁵ / ₁₆ " x 21 ¹ / ₁₆ " x 8 ⁵ / ₈ "	130 lbs.
FTBX-S3	80 ¹³ / ₁₆ " x 21 ¹ / ₁₆ " x 8 ⁵ / ₈ "	182 lbs.

All Models utilize R-404A Refrigerant.

† Shipping weights are approximate.

All Remote Drop-In Frost Top Models with Control Panel Feature:

Load: FTBX-1: 330 BTU/Hour.

FTBX-2, -2S: 630 BTU/Hour.

FTBX-3, -3S: 930 BTU/Hour.

Models Shipped with: Electronic temperature control, TXV valve (shipped loose) and a solenoid valve attached to well.

PARTS ONLY GUARANTEED FOR ONE YEAR. AN ADDITIONAL FOUR YEAR EXTENDED PARTS ONLY WARRANTY ON THE COMPRESSOR AVAILABLE AT THE TIME OF UNIT PURCHASE.

PARTS ONLY GUARANTEED FOR ONE YEAR.

OPTIONS (available at time of purchase only)

EWC Additional Four Year Extended Parts Only Warranty on the Compressor (FTBR only)

ACCESSORIES (available for purchase at any time)

ALUM PAN Half-Size Sheet Pan – 18"W x 13"D

18" SHEET PAN Full-Size Sheet Pan – 18"W x 26"D

COUNTERTOP CUT-OUT DIMENSIONS – PAGE 16

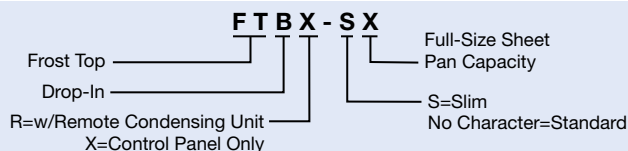



Modular/Ganged Heated Wells Ordering Instructions

Cutaway of **HWBI-5MA**
with accessory food pans
and optional split
control boxes

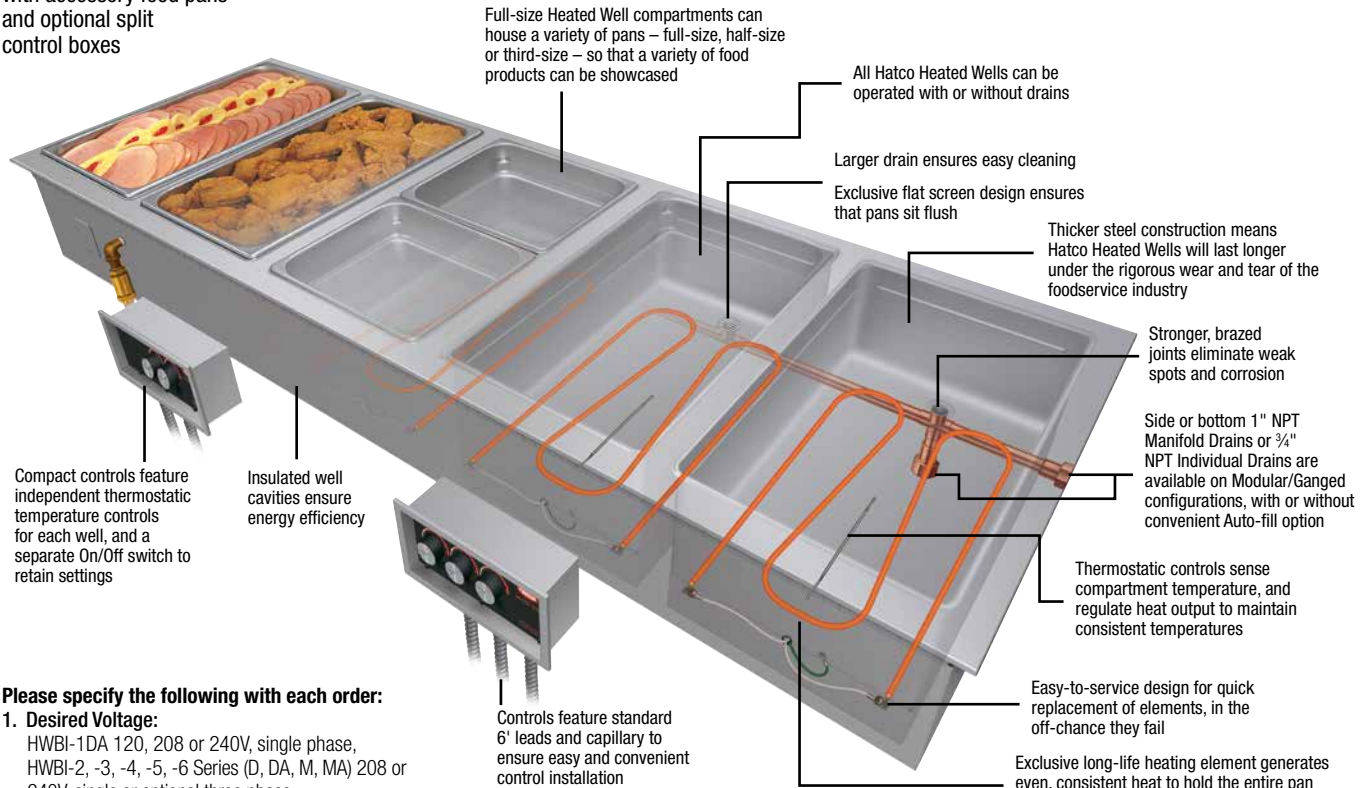

Full-size Heated Well compartments can house a variety of pans – full-size, half-size or third-size – so that a variety of food products can be showcased

All Hatco Heated Wells can be operated with or without drains

Larger drain ensures easy cleaning

Exclusive flat screen design ensures that pans sit flush

Thicker steel construction means Hatco Heated Wells will last longer under the rigorous wear and tear of the foodservice industry

Stronger, brazed joints eliminate weak spots and corrosion

Side or bottom 1" NPT Manifold Drains or 3/4" NPT Individual Drains are available on Modular/Ganged configurations, with or without convenient Auto-fill option

Thermostatic controls sense compartment temperature, and regulate heat output to maintain consistent temperatures

Easy-to-service design for quick replacement of elements, in the off-chance they fail

Exclusive long-life heating element generates even, consistent heat to hold the entire pan of food at optimum serving temperatures for longer periods of time

Compact controls feature independent thermostatic temperature controls for each well, and a separate On/Off switch to retain settings

Insulated well cavities ensure energy efficiency

Controls feature standard 6' leads and capillary to ensure easy and convenient control installation

Please specify the following with each order:

1. Desired Voltage:

HWBI-1DA 120, 208 or 240V, single phase,
HWBI-2, -3, -4, -5, -6 Series (D, DA, M, MA) 208 or 240V, single or optional three phase,
HWBLI-1DA, -2, -3, -4, -5, -6 Series (D, DA, M, MA) 120V, single phase

2. Desired Wattage:

- A. Standard Watt
- B. Low Watt (120V only)

3. Number of Modular/Ganged Heated Wells Required:

1-, 2-, 3-, 4-, 5- or 6-pan

NOTE: Modular/Ganged units are only offered as rectangular, full-size (12" x 20")

4. Drain (With or without – choose drain below):

- A. Standard Individual Well 3/4" NPT Drain
- B. Manifold 1" NPT Drain with side drain, field selectable left or right side (Available on HWBI- or HWBLI-2, -3, -4, -5, -6 models only)
- C. Manifold 1" NPT Drain with bottom drain, field selectable left or right well (Available on HWBI- or HWBLI-2, -3, -4, -5, -6 models only)

5. Auto-fill (with or without)

6. Mounting Style (all Modular/Ganged units are top mounted only):

- A. EZ Locking Hardware
- B. EZ Locking Hardware with 2" Studs
- C. EZ Locking Hardware with Surface Holes

7. Bezel Allows a 27" D for modular units to match Hatco CWB models in a countertop display

8. Agency:

- A. UL, C-UL
- B. UL-EPH (Sanitary listing)

9. Control:

- A. Single Control box (Standard on all units)
- B. Split Controls boxes (optional on 4-, 5-, 6-pan units, not available in Canada)

Accessories for Modular/Ganged Heated Wells

- 1. Pan Support Bars:** 12" or 20"
- 2. Adapters** to convert Modular/Ganged units to hold 4- or 7-Quart round pans
- 3. Stainless Steel Pans:**
 - A. Third-size (12 3/4"W x 6 7/8"D x 2 1/2"H)
 - B. Half-size (12 3/4"W x 10 3/8"D x 2 1/2"H)
 - C. Full-size at 2 1/2" deep (12 3/4"W x 20 3/4"D x 2 1/2"H)
 - D. Full-size at 4" deep (12 3/4"W x 20 3/4"D x 4"H)
 - E. Full-size at 6" deep (12 3/4"W x 20 3/4"D x 6"H)
- 4. Valves:**
 - A. 3/4" or 1" NPT Ball Valve
 - B. 3/4" or 1" NPT Gate Valve

ACCESSORIES – PAGE 32-33

DROP-IN MODULAR/GANGED HEATED WELLS COUNTERTOP CUT-OUTS

Model	Minimum Width	Maximum Width*	Minimum Depth	Maximum Depth*
HWBI-1 Series	14 1/8"	14 9/16"	22 1/4"	22 1/2"
HWBI-2 Series	28 1/8"	28 5/16"	22 1/4"	22 1/2"
HWBI-3 Series	42 1/8"	42 5/16"	22 1/4"	22 1/2"
HWBI-4 Series	56 1/8"	56 5/16"	22 1/4"	22 1/2"
HWBI-5 Series	70 1/8"	70 5/16"	22 1/4"	22 1/2"
HWBI-6 Series	84 1/8"	84 5/16"	22 1/4"	22 1/2"

*Add 1/16" to Maximum Width when using EZ locking mount.



From the top, the modular design allows the Modular/Ganged Heated Well to appear as one integrated unit. From below, you will see separate covers, with easy, independent access to each one. This makes installation and service easy

Modular/Ganged Heated Wells

Hatco Modular/Ganged Heated Wells are full-size units that are grouped together in a modular fashion to provide customers with a complete steam table contained within one piece of equipment for a clean, integrated look.

- Full-size, insulated wells available in 1 to 6 ganged units in either standard or low wattages
- Individual thermostatic controls for each well provide the ultimate in temperature regulation
- 6" conduit is standard for convenient placement of controls
- Wells empty quickly and easily with a manifold drain option
- Auto-fill option to automatically fill and replenish water without user maintenance and intervention
- Separate well assemblies with independent access to each one for easy service



HWBLI-5MA with accessory food pans and standard single control box

LOW WATT DROP-IN MODULAR/GANGED FULL-SIZE RECTANGULAR WELLS – INSULATED – TOP MOUNT

Model	Dimensions (W x D x H)	Watts	Ship Weight
HWBLI-1	15½" x 23¾" x 9⅝"	750	38 lbs.
HWBLI-1D	15½" x 23¾" x 9⅝"	750	38 lbs.
HWBLI-1DA	15½" x 23¾" x 9⅝"	750	38 lbs.
HWBLI-2	29½" x 23¾" x 9⅝"	1500	73 lbs.
HWBLI-2D	29½" x 23¾" x 9⅝"	1500	77 lbs.
HWBLI-2DA*	29½" x 23¾" x 9⅝"	1500	87 lbs.
HWBLI-2M	29½" x 23¾" x 9⅝"	1500	74 lbs.
HWBLI-2MA	29½" x 23¾" x 9⅝"	1500	85 lbs.
HWBLI-3	43½" x 23¾" x 9⅝"	2250	106 lbs.
HWBLI-3D	43½" x 23¾" x 9⅝"	2250	100 lbs.
HWBLI-3DA*	43½" x 23¾" x 9⅝"	2250	112 lbs.
HWBLI-3M	43½" x 23¾" x 9⅝"	2250	108 lbs.
HWBLI-3MA	43½" x 23¾" x 9⅝"	2250	112 lbs.
HWBLI-4	57½" x 23¾" x 9⅝"	3000	134 lbs.
HWBLI-4D	57½" x 23¾" x 9⅝"	3000	136 lbs.
HWBLI-4DA*	57½" x 23¾" x 9⅝"	3000	133 lbs.
HWBLI-4M	57½" x 23¾" x 9⅝"	3000	138 lbs.
HWBLI-4MA	57½" x 23¾" x 9⅝"	3000	138 lbs.
HWBLI-5	71½" x 23¾" x 9⅝"	3750	167 lbs.
HWBLI-5D	71½" x 23¾" x 9⅝"	3750	166 lbs.
HWBLI-5DA*	71½" x 23¾" x 9⅝"	3750	167 lbs.
HWBLI-5M	71½" x 23¾" x 9⅝"	3750	166 lbs.
HWBLI-5MA	71½" x 23¾" x 9⅝"	3750	165 lbs.
HWBLI-6	85½" x 23¾" x 9⅝"	4500	190 lbs.
HWBLI-6D	85½" x 23¾" x 9⅝"	4500	190 lbs.
HWBLI-6DA*	85½" x 23¾" x 9⅝"	4500	193 lbs.
HWBLI-6M	85½" x 23¾" x 9⅝"	4500	190 lbs.
HWBLI-6MA	85½" x 23¾" x 9⅝"	4500	197 lbs.

* Auto-fill located on left control only and fills left-hand well. To fill all wells, drains must be connected with external manifold by installer.

All Low Watt Drop-In Modular/Ganged Full-Size Insulated Top Mount Rectangular Heated Well Models Feature:

Voltage: HWBLI-1DA, 2, -3, -4, -5, -6 Series: 120V, single phase only.
Models Shipped with: EZ locking hardware for installation and remote thermostats with flexible conduits and lighted power switches.

COUNTERTOP CUT-OUT DIMENSIONS – PAGE 18 ACCESSORIES – PAGE 32-33

OPTIONS (available at time of purchase only)

HWB-HOLE	Surface Hole Mounting to Countertop (includes EZ Lock)
HWB-STUD	Stud Mounting to Countertop (includes EZ Lock)
HWBI-SIDE	Manifold Drain with Side Exit (not available on HWBLI-1)
HWBI-BOTTOM	Manifold Drain with Bottom Exit (not available on HWBLI-1)
HWBLI-CORD-2	Cord for HWBLI-2 (single phase only)
HWBLI-CORD-3	Cord for HWBLI-3 (single phase only)
OS-BEZEL	27" deep Bezel for Modular unit to match Hatco CWB in a Countertop display

Modular/Ganged Heated Wells Controls *

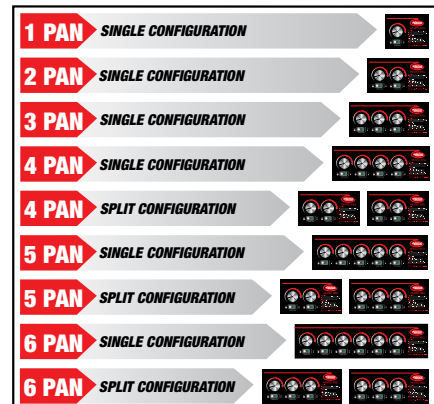

*4-, 5-, 6-pan units: Single control box is standard. If optional split control boxes are desired, it must be specified at order (for Canada, split control boxes not available).

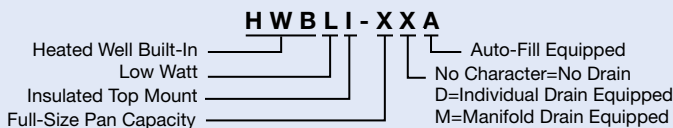

ONE YEAR ON-SITE PARTS AND LABOR WARRANTY PLUS ONE ADDITIONAL YEAR PARTS-ONLY WARRANTY ON THE METAL SHEATHED HEATING ELEMENTS.



Modular/Ganged Heated Wells - Continued

STANDARD WATT DROP-IN MODULAR/GANGED FULL-SIZE RECTANGULAR WELLS – INSULATED – TOP MOUNT

Model	Dimensions W x D x H	Watts	Ship Weight
HWBI-1	15½" x 23¾" x 9¾"	1215	38 lbs.
HWBI-1D	15½" x 23¾" x 9¾"	1215	38 lbs.
HWBI-1DA	15½" x 23¾" x 9¾"	1215	38 lbs.
HWBI-2	29½" x 23¾" x 9¾"	2415	73 lbs.
HWBI-2D	29½" x 23¾" x 9¾"	2415	77 lbs.
HWBI-2DA*	29½" x 23¾" x 9¾"	2415	87 lbs.
HWBI-2M	29½" x 23¾" x 9¾"	2415	74 lbs.
HWBI-2MA	29½" x 23¾" x 9¾"	2415	85 lbs.
HWBI-3	43½" x 23¾" x 9¾"	3615	103 lbs.
HWBI-3D	43½" x 23¾" x 9¾"	3615	100 lbs.
HWBI-3DA*	43½" x 23¾" x 9¾"	3615	112 lbs.
HWBI-3M	43½" x 23¾" x 9¾"	3615	108 lbs.
HWBI-3MA	43½" x 23¾" x 9¾"	3615	112 lbs.
HWBI-4	57½" x 23¾" x 9¾"	4815	132 lbs.
HWBI-4D	57½" x 23¾" x 9¾"	4815	136 lbs.
HWBI-4DA*	57½" x 23¾" x 9¾"	4815	133 lbs.
HWBI-4M	57½" x 23¾" x 9¾"	4815	138 lbs.
HWBI-4MA	57½" x 23¾" x 9¾"	4815	138 lbs.
HWBI-5	71½" x 23¾" x 9¾"	6015	167 lbs.
HWBI-5D	71½" x 23¾" x 9¾"	6015	166 lbs.
HWBI-5DA*	71½" x 23¾" x 9¾"	6015	167 lbs.
HWBI-5M	71½" x 23¾" x 9¾"	6015	166 lbs.
HWBI-5MA	71½" x 23¾" x 9¾"	6015	165 lbs.
HWBI-6	85½" x 23¾" x 9¾"	7215	190 lbs.
HWBI-6D	85½" x 23¾" x 9¾"	7215	190 lbs.
HWBI-6DA*	85½" x 23¾" x 9¾"	7215	193 lbs.
HWBI-6M	85½" x 23¾" x 9¾"	7215	190 lbs.
HWBI-6MA	85½" x 23¾" x 9¾"	7215	197 lbs.

* Auto-fill located on left control only and fills left-hand well. To fill all wells, drains must be connected with external manifold by installer.

All Standard Watt Drop-In Modular/Ganged Full-Size Rectangular Insulated Top Mount Heated Well Models Feature:

Voltage: HWBI-1 Series: 120, 208 or 240V, single phase.

HWBI-2, -3, -4, -5, -6 Series: 208 or 240V, single phase or optional three phase.

Models Shipped with: EZ locking hardware for installation and remote thermostats with flexible conduits and lighted power switches.

COUNTERTOP CUT-OUT DIMENSIONS – PAGE 18
ACCESSORIES – PAGE 32-33

OPTIONS (available at time of purchase only)

HWB-HOLE	Surface Hole Mounting to Countertop (includes EZ Lock)
HWB-STUD	Stud Mounting to Countertop (includes EZ Lock)
HWBI-3PH	Three-Phase Wiring (not available on HWBI-1 Series)
HWBI-SIDE	Manifold Drain with Side Exit (not available on HWBI-1)
HWBI-BOTTOM	Manifold Drain with Bottom Exit (not available on HWBI-1)
HWBI-CORD-1, -2	Cord for HWBI-1, -2 (single phase only)
HWBI-CORD-3, -4	Cord for HWBI-3, -4 (single phase only/single control box only)
HWBI-CORD-5, -6	Cord for HWBI-5, -6 (single phase only/single control box only)
OS-BEZEL	27" deep Bezel for Modular unit to match Hatco CWB in a Countertop display

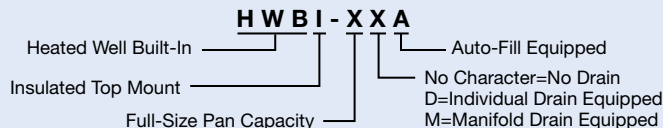

HWBI-3MA with accessory food pans and optional Cord for HWBI-3

Modular/Ganged Heated Wells Controls*

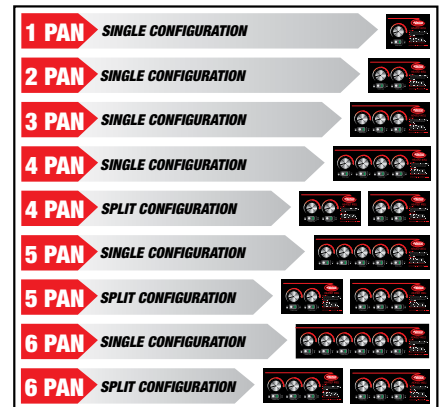

*4-, 5-, 6-pan units: Single control box is standard. If optional split control boxes are desired, it must be specified at order (for Canada, split control boxes not available).

DROP-IN MODULAR/GANGED 3 Ø AMP RATINGS

Model	208V/3 Ø Amps	240V/3 Ø Amps
HWBI-2	10.1	8.7
HWBI-3	10.1	8.8
HWBI-4	15.8	13.7
HWBI-5	20.1	17.4
HWBI-6	20.1	17.4

ONE YEAR ON-SITE PARTS AND LABOR WARRANTY PLUS ONE ADDITIONAL YEAR PARTS-ONLY WARRANTY ON THE METAL SHEATHED HEATING ELEMENTS.

Modular/Ganged Slim Heated Wells Ordering Instructions

Cutaway of **HWBI-S4MA** with accessory food pans and standard single controls

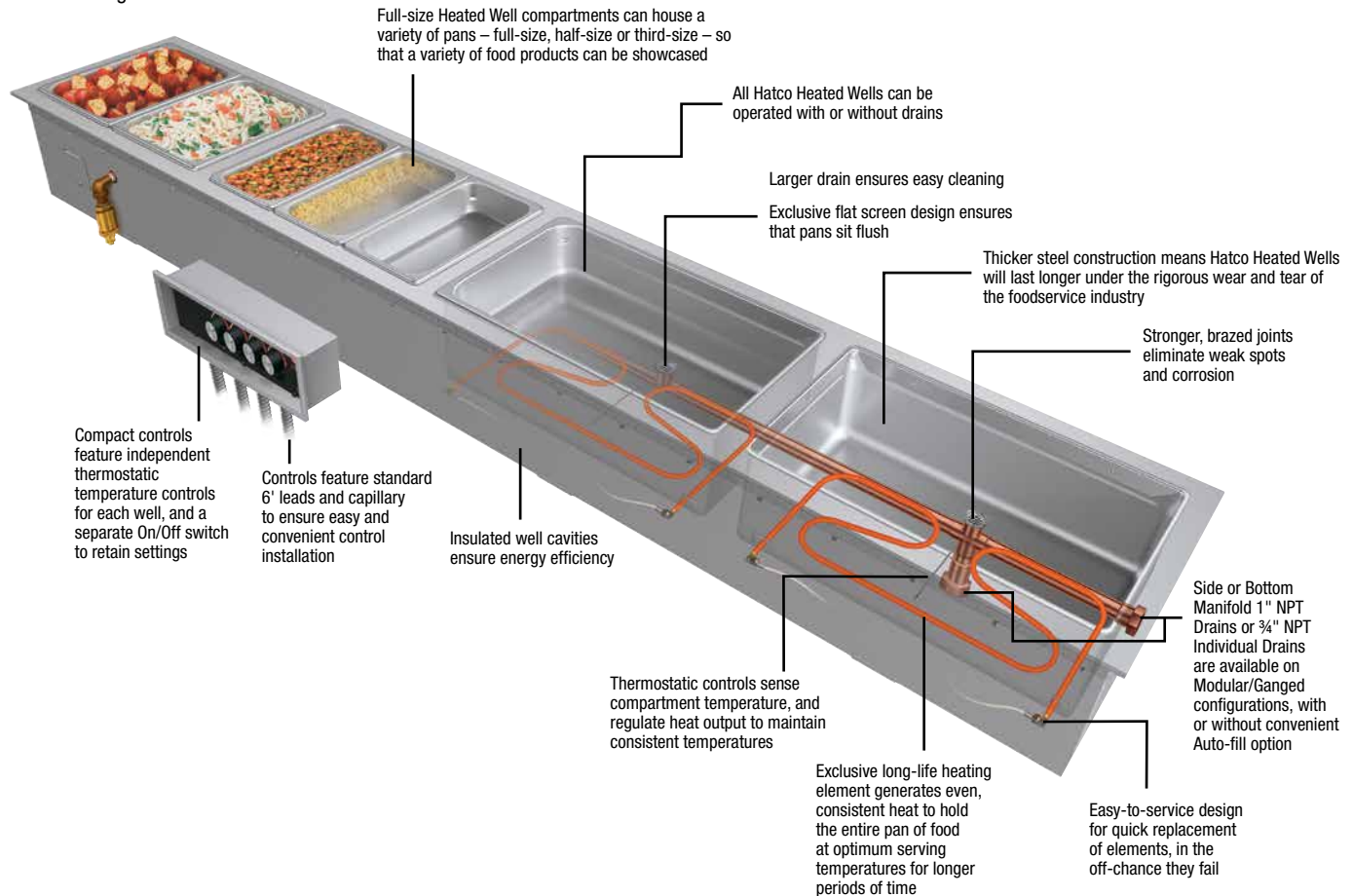

Please specify the following with each order:

1. **Desired Voltage:** 208 or 240V
 - A. Single phase (Standard)
 - B. Three phase (Optional)
2. **Number of Modular/Ganged Slim Heated Wells Required:** 2-, 3-, 4-pan

NOTE: Modular/Ganged Slim units are only offered as rectangular, full-size (placed lengthwise) (12" x 20")
3. **Drain** (with or without – choose drain below):
 - A. Standard Individual Well 3/4" NPT Drain
 - B. Manifold 1" NPT Drain with side drain, field selectable left or right side
 - C. Manifold 1" NPT Drain with bottom drain, field selectable left or right well
4. **Auto-fill** (with or without)
5. **Agency:**
 - A. UL
 - B. UL-EPH (sanitary listing)
6. **Control:**
 - A. Single Control box (Standard on all units)
 - B. Split Control boxes (Optional on 4-pan units, not available in Canada)

Accessories for Modular/Ganged Slim Heated Wells

1. **Pan Support Bars:** 12" or 20"
2. **Adapters** to convert Modular/Ganged Slim units to hold 4- or 7-Quart round pans
3. **Stainless Steel Pans:**
 - A. Third-size at 2 1/2" deep (12 3/4"W x 6 7/8"D x 2 1/2"H)
 - B. Half-size at 2 1/2" deep (12 3/4"W x 10 3/8"D x 2 1/2"H)
 - C. Full-size at 2 1/2" deep (12 3/4"W x 20 3/4"D x 2 1/2"H)
 - D. Full-size at 4" deep (12 3/4"W x 20 3/4"D x 4"H)
 - E. Full-size at 6" deep (12 3/4"W x 20 3/4"D x 6"H)
4. **Valves:**
 - A. 3/4" or 1" NPT Ball Valve
 - B. 3/4" or 1" NPT Gate Valve

ACCESSORIES – PAGE 32-33

DROP-IN MODULAR/GANGED SLIM HEATED WELLS COUNTERTOP CUT-OUTS

Model	Minimum Width	Maximum Width	Minimum Depth	Maximum Depth
HWBI-S2 Series	44 1/8"	44 3/8"	14 1/4"	14 1/2"
HWBI-S3 Series	66 1/8"	66 3/8"	14 1/4"	14 1/2"
HWBI-S4 Series	88 1/8"	88 3/8"	14 1/4"	14 1/2"



Modular/Ganged Slim Heated Wells

Hatco Modular/Ganged Slim Heated Wells are full-sized units that are grouped together in a modular fashion but placed lengthwise. This provides customers with a complete steam table within easy reach, regardless of the sneeze guards. Select the configuration that's right for your foodservice operation.

- Full-size, insulated wells available in 2 to 4 ganged units
- Individual thermostatic controls for each well provide the ultimate in temperature regulation
- 6' conduit is standard for convenient placement of controls
- Wells empty quickly and easily with a manifold drain option
- Auto-fill option to automatically fill and replenish water without user maintenance and intervention
- Separate well assemblies with independent access to each one for easy service



HWBI-S4MA with accessory food pans and optional split control boxes

DROP-IN MODULAR/GANGED SLIM RECTANGULAR WELLS – INSULATED – TOP MOUNT

Model	Dimensions W x D x H	Watts	Ship Weight
HWBI-S2	45½" x 15½" x 9⅞"	2415	84 lbs.
HWBI-S2D	45½" x 15½" x 9⅞"	2415	81 lbs.
HWBI-S2DA*	45½" x 15½" x 9⅞"	2415	81 lbs.
HWBI-S2M	45½" x 15½" x 9⅞"	2415	84 lbs.
HWBI-S2MA	45½" x 15½" x 9⅞"	2415	91 lbs.
HWBI-S3	67½" x 15½" x 9⅞"	3615	118 lbs.
HWBI-S3D	67½" x 15½" x 9⅞"	3615	115 lbs.
HWBI-S3DA*	67½" x 15½" x 9⅞"	3615	125 lbs.
HWBI-S3M	67½" x 15½" x 9⅞"	3615	125 lbs.
HWBI-S3MA	67½" x 15½" x 9⅞"	3615	125 lbs.
HWBI-S4	89½" x 15½" x 9⅞"	4815	155 lbs.
HWBI-S4D	89½" x 15½" x 9⅞"	4815	155 lbs.
HWBI-S4DA*	89½" x 15½" x 9⅞"	4815	160 lbs.
HWBI-S4M	89½" x 15½" x 9⅞"	4815	154 lbs.
HWBI-S4MA	89½" x 15½" x 9⅞"	4815	153 lbs.

* Auto-fill located on left control only and fills left-hand well. To fill all wells, drains must be connected with external manifold by installer.

All Drop-In Modular Slim Rectangular Insulated Top Mount Heated Well Models Feature:

Voltage: HWBI-S2, -S3, -S4 Series: 208 or 240V, single phase or optional three phase.
Models Shipped with: EZ locking hardware for installation and remote thermostats with lighted power switches.

OPTIONS (available at time of purchase only)

HWBI-3PH	Three-Phase Wiring (field convertible)
HWBI-SIDE	Manifold Drain with Side Exit
HWBI-BOTTOM	Manifold Drain with Bottom Exit
HWBI-CORD-S2	Cord for HWBI-S2 (single phase only)
HWBI-CORD-S3, -S4	Cord for HWBI-S3, -S4 (single phase/single control box only)

COUNTERTOP CUT-OUT DIMENSIONS – PAGE 21 ACCESSORIES – PAGE 32-33

Modular/Ganged Slim Heated Wells Controls*

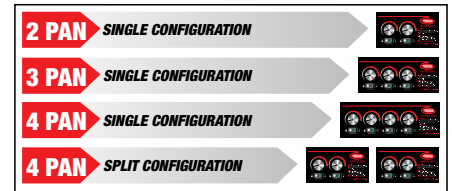

*4-pan units: Single control box is standard. If optional split control boxes are desired, it must be specified at order (For Canada, split control boxes not available).

DROP-IN SLIM MODULAR/GANGED 3 Ø AMP RATINGS

Model	208V/3 Ø Amps	240V/3 Ø Amps
HWBI-S2	10.1	8.7
HWBI-S3	10.1	8.8
HWBI-S4	15.8	13.7

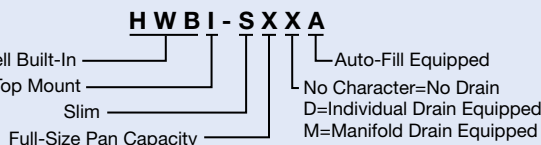

ONE YEAR ON-SITE PARTS AND LABOR WARRANTY PLUS ONE ADDITIONAL YEAR PARTS-ONLY WARRANTY ON THE METAL SHEATHED HEATING ELEMENTS.

Individual Built-In Heated Wells Ordering Instructions

Please specify the following with each order:

1. **Desired Voltage:** 120, 208 or 240V
2. **Base Size of Heated Well:**
 - A. Rectangular:
 - Full (12" x 20") or 4/3 (12" x 27")
 - B. Round:
 - 4-Quart, 7-Quart or 11-Quart
3. **Drain** (With or without)
4. **Auto-fill** (With or without)
5. **Insulated or Uninsulated**
NOTE: Only applies to rectangular full-size and 4/3-size units



Insulated Well Construction
Full-size models are available with insulation for energy savings

6. **Mounting Style:**
 - A. Top Mounted
 - B. Bottom Mounted (Rectangular full-size units only)
7. **Wattage:**
 - A. High Watt
 - B. Standard Watt
 - C. Low Watt (120V only)**NOTE:** Round Heated Wells are only available in Standard and High Watt configurations (4-Quart available in Standard Watt only)
8. **Agency:**
 - A. UL and C-UL
 - B. UR (UL Recognized – conduit and control enclosure not included [Fabricators will need to obtain UL approvals])
 - C. C-UR (C-UL Recognized – conduit and control enclosure not included [Fabricators will need to obtain UL approvals])
 - D. UL-EPH (Sanitary listing)

CONTROL BOXES, COUNTERTOP CUT-OUT DIMENSIONS – PAGE 24



Top Mounted Heated Well: Unit is mounted through the top surface of a sheet metal counter and secured with turn tabs (unit and food pan edge visible)



Bottom Mounted Heated Well: Full-size (only) unit is mounted to the bottom surface of a sheet metal counter and secured with customer provided turned bends and fasteners (food pan edge visible)

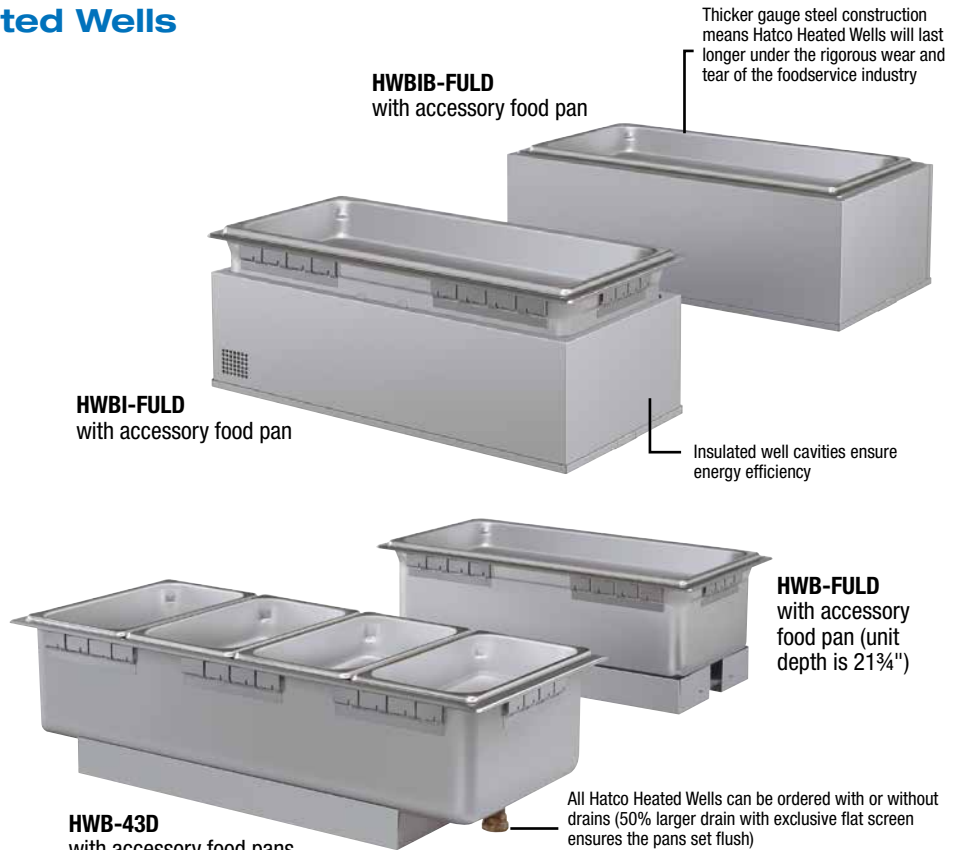

Easy to access the heating elements, if it ever becomes necessary to change them

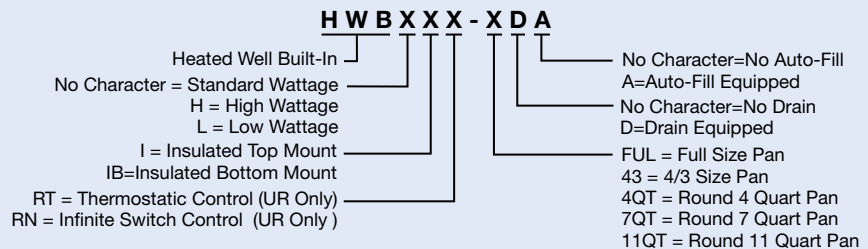



Individual Built-In Heated Wells Ordering Instructions

Options for Individual Built-In Heated Wells

1. Control Box:

- A. Standard (Compact) Thermostatic Control Box with lighted On/Off rocker switch and decorative bezel. Can be front mounted or back mounted, and used with or without the decorative bezel (Not available for Auto-fill)
- B. Optional Larger (Front mounted) Recessed Thermostatic Control Box with lighted On/Off rocker switch and angled recessed controls for easy readability. (Not available for Auto-fill)
- C. Optional WM Control Assembly available that will replace most existing controls (Not for Auto-fill)
- D. Optional ITC Control (Not available for Auto-fill, 4-Quart Round Wells, or Low Watt configurations)
- E. Standard Control for Auto-fill models only

2. Control Type:

- A. Thermostatic
- B. Infinite

NOTE: Infinite controls are only available on UR units

3. Leads – Extended high temp lead wire, per foot (1 foot standard)

4. Thermostat with 6' capillary (3' standard)



Standard Thermostatic Control with bezel (Not for Auto-fill)



WM Control Assembly (Not for Auto-fill)



Optional Larger Recessed Thermostatic Control – No Charge (Not for Auto-fill)



Optional ITC Control – (Not for Auto-fill, 4-Quart Round Wells or Low Watt configurations)



HWB-43DA, HWBIB-, HWBI-FULDA Standard Control (only for Auto-fill)

Accessories for Individual Built-In Heated Wells

- 1. **Mounting Kits** for combustible countertops (Individual Drop-In Top Mount units only)
- 2. **Pan Support Bars:** 12" or 20"
- 3. **Adapters** to convert rectangular full-size units to hold 4- or 7-Quart Round Pans, or 4/3-size units to hold 11-Quart Round Pans
- 4. **Stainless Steel Pans:**
 - A. Third-size at 2½" deep (12¾"W x 6⅞"D x 2½"H)
 - B. Half-size at 2½" deep (12¾"W x 10⅜"D x 2½"H)
 - C. Full-size at 2½" deep (12¾"W x 20¾"D x 2½"H)
 - D. Full-size at 4" deep (12¾"W x 20¾"D x 4"H)
 - E. Full-size at 6" deep (12¾"W x 20¾"D x 6"H)
- 5. **Valve**
 - A. ¾" NPT Ball Valve for unit with drain
 - B. ¾" NPT Gate Valve for unit with drain

ACCESSORIES – PAGE 32-33

CONTROL CUTOUT DIMENSIONS

Control Box	Width	Height
Standard Thermostatic (with bezel)	3¼"	3¾"
Optional Larger Recessed Thermostatic	5⅞"	6⅜"
Optional WM Control Assembly	4¾"	5"
Optional ITC	5⅞"	6⅜"
HWB-43DA, HWBIB-, HWBI-FULDA Standard Control	10⅞"	4¾"

BUILT-IN AND DROP-IN HEATED WELLS COUNTERTOP CUT-OUTS

Model	Minimum Width	Maximum Width	Minimum Depth	Maximum Depth
HWB-FUL	12⅝"	12⅞"	20⅝"	20⅞"
HWB-FUL [▲]	14"	14¼"	22"	22¼"
HWB-FULDA	12⅝"	12⅞"	20⅝"	20⅞"
HWB-FULDA [▲]	14"	14¼"	22"	22¼"
HWBI-FUL, -FULD	12¾"	12⅞"	20¾"	20⅞"
HWBI-FUL, -FULD [▲]	14"	14¼"	22"	22¼"
HWBI-FULDA [▼]	12¾"	12⅞"	20⅞"	20⅞"
HWBI-FULDA [▲]	14"	14¼"	22"	22¼"
HWBIB-FUL [▼]	12⅞"	12⅞"	20⅞"	20⅞"
HWBIB-FULDA [▼]	12⅞"	12⅞"	20⅞"	20⅞"
HWB-, HWBI-43	12⅞"	12⅞"	27⅞"	28"
HWB-, HWBI-43 [▲]	14"	14¼"	29"	29¼"
HWB-4QT	7⅞" Dia.	7⅞" Dia.	—	—
HWB-4QT [▲]	9"	9¼"	9"	9¼"
HWB-7QT	9⅞" Dia.	9⅞" Dia.	—	—
HWB-7QT [▲]	11"	11¼"	11"	11¼"
HWB-11QT	11⅞" Dia.	11⅞" Dia.	—	—
HWB-11QT [▲]	13"	13¼"	13"	13¼"

[▲] Indicates cut-out dimensions for a combustible countertop surface.

[▼] Must be flanged.

How to Order a Hatco Heated Well in Video

Hatco has given you a variety of simple and easy ways to order your well. You can read the Ordering Instructions here or watch a video "How to Order a Hatco Heated Well". Go to hatcocorp.com and click on the Video Library. While you are here, look under Product Features and Benefits and watch the "Hatco Refrigerated Wells" video as well.

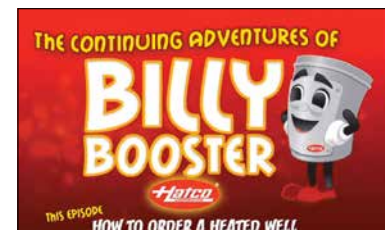

Built-In Full-Size Heated Wells - UL and C-UL Models

Hatco Built-In Heated Wells hold heated foods at safe serving temperatures. Compared to other models, Hatco units offer a larger drain with a flat drain screen, more consistent holding temperatures, heavier stainless steel construction, easier-to-service design for quick change of components and a remote thermostat with separate power switch.

- Rectangular full-size only in top or bottom mount, insulated or uninsulated
- Low (120V only), Standard and High Watt
- Available with or without a drain (easy to clean with a larger drain and a flat screen)
- Easy access design allows for quick element or thermostat change
- Accessory mounting kits for combustible countertops available
- Accessory adapters to convert full-size wells to hold round pans

Control Options

- See page 24



BUILT-IN FULL-SIZE RECTANGULAR UL AND C-UL WELLS

Model	Description	Dimensions W x D x H	Voltage	Watts	Ship Weight
Low Watt					
HWBL-FUL	Uninsulated Top or Bottom Mount	13¾" x 21¾" x 8⅝"	120	750	22 lbs.
HWBL-FULD	Uninsulated Top or Bottom Mount w/Drain	13¾" x 21¾" x 8⅝"	120	750	22 lbs.
HWBL-FULDA	Uninsulated Top or Bottom Mount w/Drain, Auto-fill	13¾" x 21¾" x 8⅝"	120	765	30 lbs.†
HWBLI-FUL	Insulated Top or Bottom Mount	13¾" x 21¾" x 9½"	120	750	27 lbs.
HWBLI-FULD	Insulated Top or Bottom Mount w/Drain	13¾" x 21¾" x 9½"	120	750	26 lbs.
HWBLI-FULDA	Insulated Top Mount Only w/Drain, Auto-fill	13¾" x 21¾" x 9½"	120	765	30 lbs.
HWBLIB-FUL	Insulated Bottom Mount Only	14" x 22" x 9½"	120	750	30 lbs.
HWBLIB-FULD	Insulated Bottom Mount Only w/Drain	14" x 22" x 9½"	120	750	29 lbs.
HWBLIB-FULDA	Insulated Bottom Mount Only w/Drain, Auto-fill	14" x 22" x 9½"	120	765	35 lbs.
Standard Watt					
HWB-FUL	Uninsulated Top or Bottom Mount	13¾" x 21¾" x 8⅝"	120, 208 or 240	1200	22 lbs.
HWB-FULD	Uninsulated Top or Bottom Mount w/Drain	13¾" x 21¾" x 8⅝"	120, 208 or 240	1200	22 lbs.
HWB-FULDA	Uninsulated Top or Bottom Mount w/Drain, Auto-fill	13¾" x 21¾" x 8⅝"	120, 208 or 240	1215	30 lbs.†
HWBI-FUL	Insulated Top or Bottom Mount	13¾" x 21¾" x 9½"	120, 208 or 240	1200	26 lbs.
HWBI-FULD	Insulated Top or Bottom Mount w/Drain	13¾" x 21¾" x 9½"	120, 208 or 240	1200	25 lbs.
HWBI-FULDA	Insulated Top Mount Only w/Drain, Auto-fill	13¾" x 21¾" x 9½"	120, 208 or 240	1215	30 lbs.
HWBIB-FUL	Insulated Bottom Mount Only	14" x 22" x 9½"	120, 208 or 240	1200	29 lbs.
HWBIB-FULD	Insulated Bottom Mount Only w/Drain	14" x 22" x 9½"	120, 208 or 240	1200	29 lbs.
HWBIB-FULDA	Insulated Bottom Mount Only w/Drain, Auto-fill	14" x 22" x 9½"	120, 208 or 240	1215	35 lbs.
High Watt					
HWBH-FUL	Uninsulated Top or Bottom Mount	13¾" x 21¾" x 8⅝"	120, 208 or 240	1650	22 lbs.
HWBH-FULD	Uninsulated Top or Bottom Mount w/Drain	13¾" x 21¾" x 8⅝"	120, 208 or 240	1650	22 lbs.
HWBH-FULDA	Uninsulated Top or Bottom Mount w/Drain, Auto-fill	13¾" x 21¾" x 8⅝"	120, 208 or 240	1665	30 lbs.†
HWBHI-FUL	Insulated Top or Bottom Mount	13¾" x 21¾" x 9½"	120, 208 or 240	1650	27 lbs.
HWBHI-FULD	Insulated Top or Bottom Mount w/Drain	13¾" x 21¾" x 9½"	120, 208 or 240	1650	31 lbs.
HWBHI-FULDA	Insulated Top Mount Only w/Drain, Auto-fill	13¾" x 21¾" x 9½"	120, 208 or 240	1665	31 lbs.
HWBHIB-FUL	Insulated Bottom Mount Only	14" x 22" x 9½"	120, 208 or 240	1650	30 lbs.
HWBHIB-FULD	Insulated Bottom Mount Only w/Drain	14" x 22" x 9½"	120, 208 or 240	1650	31 lbs.
HWBHIB-FULDA	Insulated Bottom Mount Only w/Drain, Auto-fill	14" x 22" x 9½"	120, 208 or 240	1665	35 lbs.

† Shipping weights are approximate.

All Built-In Full-Size Rectangular Heated Well UL & C-UL Models Feature:

Voltage: Single phase only.

Models Shipped with: EZ locking hardware for installation (top mounted only), 3' conduits between the control and well (except auto-fill unit) and a remote thermostat with lighted power switch.

COUNTERTOP CUT-OUT DIMENSIONS – PAGE 24 OPTIONS – PAGE 26 ACCESSORIES – PAGE 32-33

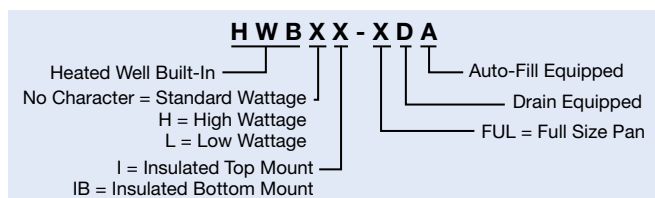

Insulated Well Construction
Full-size models are available with insulation for energy savings



ONE YEAR ON-SITE PARTS AND LABOR WARRANTY PLUS ONE ADDITIONAL YEAR PARTS-ONLY WARRANTY ON THE METAL SHEATHED HEATING ELEMENTS.



HWBL-43D and HWBLI-FULD with accessory food pans (shown with GR2AHL with standard Designer non-adjustable stands and optional Designer color and sneeze guards)

OPTIONS (available at time of purchase only)

Designer Colors for Flush Mount Control Box Bezel (not available for HWB-FUL with Cord) – Non-standard colors are non-returnable) –

RED	Warm Red
BLACK	Black
GRAY	Gray Granite
WHITE	White Granite
NAVY	Navy Blue
GREEN	Hunter Green
COPPER	Antique Copper
HWB-LEAD	High Temp Power Supply Lead Wire (Lead Wire only – Conduit not included)
HWB-CORD	HWB-FUL with Cord standard (120V only)
HWBI-CORD	HWBI-FUL Insulated Top Mount with Cord standard (120V only)
HWBIB-BRKT	Mounting Bracket for Insulated Bottom Mount (HWBIB Series)

Control Options –

HWB-TSTAT	Thermostat with 6' Capillary
HWB-RTC	Larger Recessed Thermostatic Control Box
HWB-ITC	ITC Control with Large Control Box (not available for Auto-Fill or low watt configurations)
WM Assembly	Control Assembly Replacement (not available for Auto-Fill Models)

ACCESSORIES – PAGE 32-33
COLORS AND FINISHES - PAGE 34

HWB-FUL
with optional cord
(120V only)



Standard Thermostatic Control (Control box bezel in optional Designer color)



Drop-In 4/3-Size Heated Wells - UL and C-UL Models

Convenient 4/3-Sized Wells hold heated foods at safe serving temperatures. Like the full-size models, Hatco units offer a larger drain with a flat drain screen, more consistent holding temperatures, heavier stainless steel construction, easier-to-service design for quick change of components and a remote thermostat with separate power switch.

- Rectangular 4/3-Size Wells
- Low (120V only), Standard and High Watt
- Available with or without a drain (easy to clean with larger drain and flat screen)
- Easy access design allows for quick element or thermostat change
- Accessory mounting kits for combustible countertops available
- Accessory adapters to convert 4/3-Size Wells to hold round pans available

Control Options

- See page 24

HWB-43D with accessory food pans (single unit holding 4 third-size pans)



HWBI-43D with accessory food pans (single unit holding 4 third-size pans)



DROP-IN 4/3-SIZE RECTANGULAR UL AND C-UL WELLS

Model	Description	Dimensions W x D x H	Voltage	Watts	Ship Weight
Low Watt					
HWBL-43	Uninsulated	13 $\frac{5}{8}$ " x 28 $\frac{5}{8}$ " x 8 $\frac{5}{8}$ "	120	750	30 lbs.
HWBL-43D	Uninsulated w/Drain	13 $\frac{5}{8}$ " x 28 $\frac{5}{8}$ " x 8 $\frac{5}{8}$ "	120	750	24 lbs.
HWBL-43DA	Uninsulated w/Drain, Auto-fill	13 $\frac{5}{8}$ " x 28 $\frac{5}{8}$ " x 8 $\frac{5}{8}$ "	120	765	36 lbs.
HWBLI-43	Insulated	13 $\frac{5}{8}$ " x 28 $\frac{5}{8}$ " x 9 $\frac{1}{2}$ "	120	750	38 lbs.
HWBLI-43D	Insulated w/Drain	13 $\frac{5}{8}$ " x 28 $\frac{5}{8}$ " x 9 $\frac{1}{2}$ "	120	750	31 lbs.
Standard Watt					
HWB-43	Uninsulated	13 $\frac{5}{8}$ " x 28 $\frac{5}{8}$ " x 8 $\frac{5}{8}$ "	120, 208 or 240	1200	24 lbs.
HWB-43D	Uninsulated w/Drain	13 $\frac{5}{8}$ " x 28 $\frac{5}{8}$ " x 8 $\frac{5}{8}$ "	120, 208 or 240	1200	24 lbs.
HWB-43DA	Uninsulated w/Drain, Auto-fill	13 $\frac{5}{8}$ " x 28 $\frac{5}{8}$ " x 8 $\frac{5}{8}$ "	120, 208 or 240	1215	27 lbs.
HWBI-43	Insulated	13 $\frac{5}{8}$ " x 28 $\frac{5}{8}$ " x 9 $\frac{1}{2}$ "	120, 208 or 240	1200	30 lbs.
HWBI-43D	Insulated w/Drain	13 $\frac{5}{8}$ " x 28 $\frac{5}{8}$ " x 9 $\frac{1}{2}$ "	120, 208 or 240	1200	31 lbs.
High Watt					
HWBH-43	Uninsulated	13 $\frac{5}{8}$ " x 28 $\frac{5}{8}$ " x 8 $\frac{5}{8}$ "	120, 208 or 240	1650	24 lbs.
HWBH-43D	Uninsulated w/Drain	13 $\frac{5}{8}$ " x 28 $\frac{5}{8}$ " x 8 $\frac{5}{8}$ "	120, 208 or 240	1650	25 lbs.
HWBH-43DA	Uninsulated w/Drain, Auto-fill	13 $\frac{5}{8}$ " x 28 $\frac{5}{8}$ " x 8 $\frac{5}{8}$ "	120, 208 or 240	1665	30 lbs.
HWBHI-43	Insulated	13 $\frac{5}{8}$ " x 28 $\frac{5}{8}$ " x 9 $\frac{1}{2}$ "	120, 208 or 240	1650	31 lbs.
HWBHI-43D	Insulated w/Drain	13 $\frac{5}{8}$ " x 28 $\frac{5}{8}$ " x 9 $\frac{1}{2}$ "	120, 208 or 240	1650	30 lbs.

Insulated Well Construction

Full-size models are available with insulation for energy savings



All Drop-In 4/3-Size Rectangular UL & C-UL Heated Well Models Feature:

Voltage: Single phase only.

Models Shipped with: EZ locking hardware for installation, 3' conduits between the control and well (except auto-fill unit) and a remote thermostat with lighted power switch.

OPTIONS (available at time of purchase only)

HWB-LEAD	High Temp Power Supply Lead Wire (Lead Wire only - Conduit not included)
HWB-TSTAT	Thermostat with 6' Capillary
HWB-RTC	Larger Recessed Thermostatic Control Box
WM Assembly	Control Assembly Replacement (not available for Auto-Fill Models)
HWB-ITC	ITC Control with Large Control Box (not available for Auto-Fill Models)
HWB-AFL	Left Water Fill Hole for Models HWB, HWBH, HWBL-43DA only (Front is standard)
HWB-AFR	Right Water Fill Hole for Models HWB, HWBH, HWBL-43DA only (Front is standard)

OPTIONS (available at time of purchase only)

Designer Colors for Control Box Bezel - Non-standard colors are non-returnable -

RED	Warm Red
BLACK	Black
GRAY	Gray Granite
WHITE	White Granite
NAVY	Navy Blue
GREEN	Hunter Green
COPPER	Antique Copper

COUNTERTOP CUT-OUT DIMENSIONS - PAGE 24

ACCESSORIES - PAGE 32-33

COLORS AND FINISHES - PAGE 34

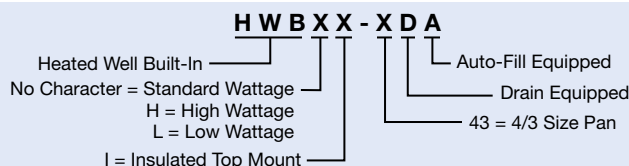

ONE YEAR ON-SITE PARTS AND LABOR WARRANTY PLUS ONE ADDITIONAL YEAR PARTS-ONLY WARRANTY ON THE METAL SHEATHED HEATING ELEMENTS.



Drop-In Round Heated Wells – UL And C-UL Models

Keeping hot food at safe serving temperatures is critical to any foodservice operation – and Hatco has the Heated Wells to meet the demands of any serving application. Thermostatic controls monitor and regulate the temperature of the well for more accurate heat and energy savings. Hatco controls feature a separate On/Off switch, which allows a previously determined setting to be maintained.

- 4-, 7- and 11-Quart Round Wells
- Standard or High Watt (4-Quart Standard Watt only)
- With or without drain
- EZ locking hardware for easy top mount installation
- Accessory mounting kits for combustible countertops available

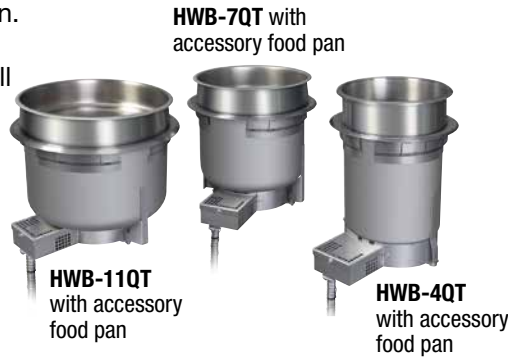

Control Options

- Standard (compact) Thermostatic Control Box with lighted On/Off rocker switch and decorative bezel. Can be front mounted or back mounted, and used with or without the decorative bezel
- Optional Larger (front mounted) Recessed Thermostatic Control Box with lighted On/Off rocker switch and angled recessed controls for easy readability
- Optional WM Control Assembly available to replace most existing controls on a customer's Drop-In Heated Well unit for easier reading
- Optional ITC Control with Large Control Box available for easier reading on 7- or 11-Quart Standard or High Watt configurations

DROP-IN ROUND UL AND C-UL MODELS – UNINSULATED

Model	Description	Dimensions Dia. x H	Watts			Ship Weight
			120V	208V	240V	
4 Quart – Standard Watt						
HWB-4QT	Top Mount	8 1/4" x 10 1/8"	500	536	600	11 lbs.
HWB-4QTD	Top Mount w/Drain	8 1/4" x 10 1/8"	500	536	600	10 lbs.
7 Quart – Standard Watt						
HWB-7QT	Top Mount	10 5/16" x 9"	500	536	600	12 lbs.
HWB-7QTD	Top Mount w/Drain	10 5/16" x 9"	500	536	600	12 lbs.
7 Quart – High Watt						
HWBH-7QT	Top Mount	10 5/16" x 9"	800	715	800	12 lbs.
HWBH-7QTD	Top Mount w/Drain	10 5/16" x 9"	800	715	800	12 lbs.
11 Quart – Standard Watt						
HWB-11QT	Top Mount	12 5/16" x 9"	500	536	600	13 lbs.
HWB-11QTD	Top Mount w/Drain	12 5/16" x 9"	500	536	600	13 lbs.
11 Quart – High Watt						
HWBH-11QT	Top Mount	12 5/16" x 9"	800	715	800	14 lbs.
HWBH-11QTD	Top Mount w/Drain	12 5/16" x 9"	800	715	800	14 lbs.



Standard Thermostatic Control with bezel

Optional Larger Recessed Thermostatic Control Shown with bezel in optional Designer White Granite



Optional ITC Control – (Not for 4-Quart Round Wells, low watt configurations or units without a drain) shown in optional control box bezel in Designer White Granite



WM Control Assembly

All Drop-In Round Uninsulated Heated Well UL & C-UL Models Feature:

Voltage: Single phase only.

Models Shipped with: EZ locking hardware for installation, 3' conduits between the control and well and a remote thermostat with lighted power switch.

OPTIONS (available at time of purchase only)

HWB-LEAD	High Temp Power Supply Lead Wire (Lead Wire only – Conduit not included)
HWB-TSTAT	Thermostat with 6' Capillary
HWB-RTC	Larger Recessed Thermostatic Control Box
WM Assembly	Control Assembly Replacement
HWB-ITC	ITC Control with Large Control Box for 7- and 11-Quart Drop-In Round Wells only

COUNTERTOP CUT-OUT DIMENSIONS – PAGE 24
 ACCESSORIES – PAGE 32-33
 COLORS AND FINISHES - PAGE 34

OPTIONS (available at time of purchase only)

Designer Colors for Control Box Bezel – Non-standard colors are non-returnable –

RED	Warm Red
BLACK	Black
GRAY	Gray Granite
WHITE	White Granite
NAVY	Navy Blue
GREEN	Hunter Green
COPPER	Antique Copper

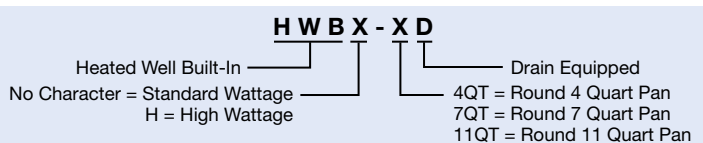

ONE YEAR ON-SITE PARTS AND LABOR WARRANTY PLUS ONE ADDITIONAL YEAR PARTS-ONLY WARRANTY ON THE METAL SHEATHED HEATING ELEMENTS.

Built-In Full-Size Heated Wells – UR and C-UR Components

Having the same great features as all of the Hatco Heated Wells, plus the added benefit of allowing fabricators the freedom to design their own steam tables, these units hold hot food products at safe serving temperatures.

NOTE: Fabricators will need to obtain UL approvals.

- Without conduit and control box enclosure
- Thermostatic or infinite controls available
- With or without drains
- Low, Standard and High Watt models

Control Options

– See page 30



HWBRT-FULD
with accessory food pan



HWBIBRT-FULD
with accessory food pan

HWBIBRT-FULD with accessory food pan

BUILT-IN FULL-SIZE RECTANGULAR UR AND C-UR HEATED WELLS

Model [■]	Description	Dimensions W x D x H	Voltage	Watts	Ship Weight
Low Watt					
HWBLRT-FUL	Uninsulated Top or Bottom Mount	13¾" x 21¾" x 8½"	120	750	21 lbs.
HWBLRT-FULD	Uninsulated Top or Bottom Mount w/Drain	13¾" x 21¾" x 8½"	120	750	24 lbs.
HWBLRN-FUL	Uninsulated Top or Bottom Mount	13¾" x 21¾" x 8½"	120	750	20 lbs.
HWBLRN-FULD	Uninsulated Top or Bottom Mount w/Drain	13¾" x 21¾" x 8½"	120	750	24 lbs.
HWBLIRT-FUL	Insulated Top or Bottom Mount	13¾" x 21¾" x 9½"	120	750	27 lbs.
HWBLIRT-FULD	Insulated Top or Bottom Mount w/Drain	13¾" x 21¾" x 9½"	120	750	19 lbs.
HWBLIBRT-FUL	Insulated Bottom Mount Only	14" x 22" x 9½"	120	750	28 lbs.
HWBLIBRT-FULD	Insulated Bottom Mount Only w/Drain	14" x 22" x 9½"	120	750	26 lbs.
Standard Watt					
HWBRT-FUL	Uninsulated Top or Bottom Mount	13¾" x 21¾" x 8½"	120, 208 or 240	1200	19 lbs.
HWBRT-FULD	Uninsulated Top or Bottom Mount w/Drain	13¾" x 21¾" x 8½"	120, 208 or 240	1200	20 lbs.
HWBRN-FUL	Uninsulated Top or Bottom Mount	13¾" x 21¾" x 8½"	120, 208 or 240	1200	19 lbs.
HWBRN-FULD	Uninsulated Top or Bottom Mount w/Drain	13¾" x 21¾" x 8½"	120, 208 or 240	1200	20 lbs.
HWBIRT-FUL	Insulated Top or Bottom Mount	13¾" x 21¾" x 9½"	120, 208 or 240	1200	24 lbs.
HWBIRT-FULD	Insulated Top or Bottom Mount w/Drain	13¾" x 21¾" x 9½"	120, 208 or 240	1200	26 lbs.
HWBIBRT-FUL	Insulated Bottom Mount Only	14" x 22" x 9½"	120, 208 or 240	1200	27 lbs.
HWBIBRT-FULD	Insulated Bottom Mount Only w/Drain	14" x 22" x 9½"	120, 208 or 240	1200	26 lbs.
High Watt					
HWBHRT-FUL	Uninsulated Top or Bottom Mount	13¾" x 21¾" x 8½"	120, 208 or 240	1650	21 lbs.
HWBHRT-FULD	Uninsulated Top or Bottom Mount w/Drain	13¾" x 21¾" x 8½"	120, 208 or 240	1650	18 lbs.
HWBHRN-FUL*	Uninsulated Top or Bottom Mount	13¾" x 21¾" x 8½"	120, 208 or 240	1650	21 lbs.
HWBHRN-FULD*	Uninsulated Top or Bottom Mount w/Drain	13¾" x 21¾" x 8½"	120, 208 or 240	1650	20 lbs.
HWBHIRT-FUL	Insulated Top or Bottom Mount	13¾" x 21¾" x 9½"	120, 208 or 240	1650	26 lbs.
HWBHIRT-FULD	Insulated Top or Bottom Mount w/Drain	13¾" x 21¾" x 9½"	120, 208 or 240	1650	28 lbs.
HWBHIBRT-FUL	Insulated Bottom Mount Only	14" x 22" x 9½"	120, 208 or 240	1650	29 lbs.
HWBHIBRT-FULD	Insulated Bottom Mount Only w/Drain	14" x 22" x 9½"	120, 208 or 240	1650	28 lbs.

* 208V or 240V only.

■ "RT" added to model name indicates unit with thermostat control, lit rocker switch and 36" capillary.

"RN" added to model name indicates unit with infinite switch control, pilot light and 36" leads.

All Built-In Full-Size Rectangular UR & C-UR Heated Well Models Feature:

Voltage: Single phase only.

Models Shipped with: EZ locking hardware for installation (top mounted only).

OPTIONS (available at time of purchase only) – UR and C-UR COMPONENTS ONLY

HWB-LEAD-UR High Temp Power Supply Lead Wire for "RN" Components (Lead Wire only – Conduit not included)

HWB-TSTAT-UR Thermostat with 6' Capillary for "RT" Components (Thermostat only – Conduit not included)

COUNTERTOP CUT-OUT DIMENSIONS – PAGE 24 ACCESSORIES – PAGE 32-33

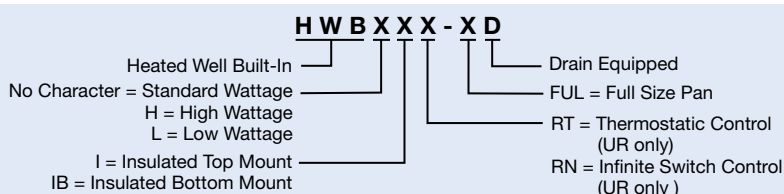

ONE YEAR ON-SITE PARTS AND LABOR WARRANTY PLUS ONE ADDITIONAL YEAR PARTS-ONLY WARRANTY ON THE METAL SHEATHED HEATING ELEMENTS.



Drop-In 4/3-Size Heated Wells – UR and C-UR Components

Having the same great features as all of the Hatco Heated Wells, plus the added benefit of allowing fabricators the freedom to design their own steam tables with UL recognized components, these units hold hot food products at safe serving temperatures.

NOTE: Fabricators will need to obtain UL approvals.

- Without conduit and control box enclosure
- Thermostatic or infinite controls available
- With or without drains
- Low, Standard and High Watt models



HWBRT-43D with accessory food pans (single unit can hold 4 third-size pans)

Control Options

The UR and C-UR Models can have the following control choices:

- Thermostatic Controls, which feature an On/Off switch with light
- Infinite Controls – available with indicator light



Thermostatic Control



Infinite Control

CONTROL CUTOUT DIMENSIONS

Control	Width	Height
Thermostatic	2 1/8"	3 3/8"
Infinite	2 1/8"	3 3/8"

DROP-IN 4/3-SIZE RECTANGULAR UR AND C-UR WELLS

Model #	Description	Dimensions W x D x H	Voltage	Watts	Ship Weight
Low Watt					
HWBLRT-43	Uninsulated	13 3/8" x 28 5/8" x 8 5/8"	120	750	30 lbs.
HWBLRT-43D	Uninsulated w/Drain	13 3/8" x 28 5/8" x 8 5/8"	120	750	33 lbs.
HWBLRN-43	Uninsulated	13 3/8" x 28 5/8" x 8 5/8"	120	750	21 lbs.
HWBLRN-43D	Uninsulated w/Drain	13 3/8" x 28 5/8" x 8 5/8"	120	750	33 lbs.
Standard Watt					
HWBRT-43	Uninsulated	13 3/8" x 28 5/8" x 8 5/8"	120, 208 or 240	1200	23 lbs.
HWBRT-43D	Uninsulated w/Drain	13 3/8" x 28 5/8" x 8 5/8"	120, 208 or 240	1200	21 lbs.
HWBRN-43	Uninsulated	13 3/8" x 28 5/8" x 8 5/8"	120, 208 or 240	1200	21 lbs.
HWBRN-43D	Uninsulated w/Drain	13 3/8" x 28 5/8" x 8 5/8"	120, 208 or 240	1200	21 lbs.
High Watt					
HWBHRT-43	Uninsulated	13 3/8" x 28 5/8" x 8 5/8"	120, 208 or 240	1650	30 lbs.
HWBHRT-43D	Uninsulated w/Drain	13 3/8" x 28 5/8" x 8 5/8"	120, 208 or 240	1650	21 lbs.
HWBHRN-43*	Uninsulated	13 3/8" x 28 5/8" x 8 5/8"	120, 208 or 240	1650	30 lbs.
HWBHRN-43D*	Uninsulated w/Drain	13 3/8" x 28 5/8" x 8 5/8"	120, 208 or 240	1650	33 lbs.

* 208V or 240V only.

- "RT" added to model name indicates unit with thermostat control, lit rocker switch and 36" capillary.
- "RN" added to model name indicates unit with infinite switch control, pilot light and 36" leads.

All Drop-In 4/3-Size Rectangular UR & C-UR Heated Well Models Feature:

Voltage: Single phase only.

Models Shipped with: EZ locking hardware for installation.

OPTIONS (available at time of purchase only) – UR and C-UR COMPONENTS ONLY

HWB-LEAD-UR	High Temp Power Supply Lead Wire for "RN" Components (Lead Wire only – Conduit not included)
HWB-TSTAT-UR	Thermostat with 6' Capillary for "RT" Components (Thermostat only – Conduit not included)

COUNTERTOP CUT-OUT DIMENSIONS – PAGE 24 ACCESSORIES – PAGE 32-33

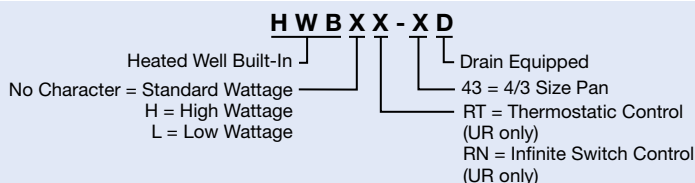

ONE YEAR ON-SITE PARTS AND LABOR WARRANTY PLUS ONE ADDITIONAL YEAR PARTS-ONLY WARRANTY ON THE METAL SHEATHED HEATING ELEMENTS.

Drop-In Round Heated Wells - UR and C-UR Components

Ideal for the fabricator who wants to design a specific steam table layout. Easy to install, and easy to service, the Round Heated Wells come with control, size, drain and wattage choices.

- 4-, 7- and 11-Quart Round Heated Wells
- Standard or High Watt (4-Quart Standard Watt only)
- With or without drain
- Thermostatic or infinite controls available
- Without conduit and control box enclosure

HWBRT-7QT with accessory food pan, not included



HWBRT-11QT with accessory food pan, not included

HWBRT-4QT with accessory food pan, not included

NOTE: Fabricators will need to obtain UL approvals.

DROP-IN ROUND UR AND C-UR WELLS – UNINSULATED

Model #	Description	Dimensions Dia. x H	Watts			Ship Weight
			120V	208V	240V	
4 Quart – Standard Watt						
HWBRT-4QT	Top Mount	8¼" x 10½"	500	536	600	9 lbs.
HWBRT-4QTD	Top Mount w/Drain	8¼" x 10½"	500	536	600	9 lbs.
HWBRN-4QT	Top Mount	8¼" x 10½"	500	536	600	6 lbs.
HWBRN-4QTD	Top Mount w/Drain	8¼" x 10½"	500	536	600	9 lbs.
7 Quart – Standard Watt						
HWBRT-7QT	Top Mount	10 5/16" x 9"	500	536	600	11 lbs.
HWBRT-7QTD	Top Mount w/Drain	10 5/16" x 9"	500	536	600	11 lbs.
HWBRN-7QT	Top Mount	10 5/16" x 9"	500	536	600	7 lbs.
HWBRN-7QTD	Top Mount w/Drain	10 5/16" x 9"	500	536	600	10 lbs.
7 Quart – High Watt						
HWBHRT-7QT	Top Mount	10 5/16" x 9"	800	715	800	7 lbs.
HWBHRT-7QTD	Top Mount w/Drain	10 5/16" x 9"	800	715	800	9 lbs.
HWBHRN-7QT	Top Mount	10 5/16" x 9"	800	715	800	7 lbs.
HWBHRN-7QTD	Top Mount w/Drain	10 5/16" x 9"	800	715	800	13 lbs.
11 Quart – Standard Watt						
HWBRT-11QT	Top Mount	12 5/16" x 9"	500	536	600	10 lbs.
HWBRT-11QTD	Top Mount w/Drain	12 5/16" x 9"	500	536	600	11 lbs.
HWBRN-11QT	Top Mount	12 5/16" x 9"	500	536	600	10 lbs.
HWBRN-11QTD	Top Mount w/Drain	12 5/16" x 9"	500	536	600	13 lbs.
11 Quart – High Watt						
HWBHRT-11QT	Top Mount	12 5/16" x 9"	800	715	800	15 lbs.
HWBHRT-11QTD	Top Mount w/Drain	12 5/16" x 9"	800	715	800	11 lbs.
HWBHRN-11QT	Top Mount	12 5/16" x 9"	800	715	800	8 lbs.
HWBHRN-11QTD	Top Mount w/Drain	12 5/16" x 9"	800	715	800	11 lbs.

"RT" added to model name indicates unit with thermostatic control, lit rocker switch and 36" capillary.
 # "RN" added to model name indicates unit with infinite switch control, pilot light and 36" leads.

All Drop-In Round UR & C-UR Heated Well Models Feature:

Voltage: Single phase only.

Models Shipped with: EZ locking hardware for installation.

Control Options

The UR and C-UR Models can have the following control choices:

- Thermostatic controls, which feature an On/Off switch with light
- Infinite controls – available with indicator light



Thermostatic Control

Infinite Control

CONTROL CUTOUT DIMENSIONS

Control	Width	Height
Thermostatic	2 1/8"	3 3/8"
Infinite	2 1/8"	3 3/8"

OPTIONS (available at time of purchase only) – UR and C-UR COMPONENTS ONLY

- HWB-LEAD-UR High Temp Power Supply Lead Wire for "RN" Components (Lead Wire only – Conduit not included)
- HWB-TSTAT-UR Thermostat with 6' Capillary for "RT" Components (Thermostat only – Conduit not included)

COUNTERTOP CUT-OUT DIMENSIONS – PAGE 24 ACCESSORIES – PAGE 32-33

HWBXX - XD

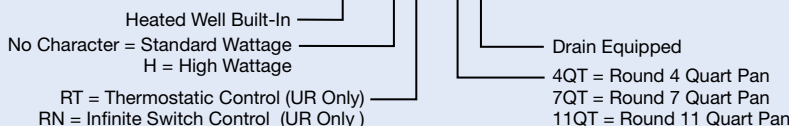

ONE YEAR ON-SITE PARTS AND LABOR WARRANTY PLUS ONE ADDITIONAL YEAR PARTS-ONLY WARRANTY ON THE METAL SHEATHED HEATING ELEMENTS.



Drop-In Hot/Cold Well and Heated Well Accessories

(available for purchase at any time)



FTB-2
with accessory
full-size
sheet pans

HWBI-2
with accessory
half and
third-size pans

PANS – LIDS – TRIVETS

ST PAN 1/3	Third-Size Stainless Steel Pan – 12¾"W x 6⅞"D x 2½"H
ST PAN 1/2	Half-Size Stainless Steel Pan – 12¾"W x 10⅜"D x 2½"H
ST PAN 2	Full-Size Stainless Steel Pan – 12¾"W x 20¾"D x 2½"H
ST PAN 4	Full-Size Stainless Steel Pan – 12¾"W x 20¾"D x 4"H
HDW 6" PAN	Full-Size Stainless Steel Pan – 12¾"W x 20¾"D x 6"H
4QT-PAN	4-Quart Round Pan
7QT-PAN	7-Quart Round Pan
11QT-PAN	11-Quart Round Pan
Notched Lid for Round Pans –	
4QT-LID-1	4-Quart Notched Lid
7QT-LID-1	7-Quart Notched Lid
11QT-LID-1	11-Quart Notched Lid
Hinged Lid for Round Pans –	
4QT-LID	4-Quart Hinged and Notched Lid
7QT-LID	7-Quart Hinged and Notched Lid
11QT-LID	11-Quart Hinged and Notched Lid
Wire Trivets Stainless –	
TRIVET (1/2)SS	Half-Size – 10⅞"W x 7⅞"D
TRIVET SS	Full-Size – 10⅞"W x 18"D

**ADAPTERS, SUPPORT BARS,
MOUNTING KITS, VALVES – PAGE 33**



Drop-In Hot/Cold Well and Heated Well Accessories

(available for purchase at any time)

ADAPTERS – SUPPORT BARS

HWB-2-7Q	Adapter to convert warmer to hold two 7-Quart Inserts (HWB-FUL & HWBI Series only)
HWB-3-4Q	Adapter to convert warmer to hold three 4-Quart Inserts (HWB-FUL & HWBI Series only)
HWB-2-11Q	Adapter to convert warmer to hold two 11-Quart Inserts (Model HWB-43 only)
HWB12BAR	12" Pan Support Bar for Built-In and Drop-In Heated Wells
HWB20BAR	20" Pan Support Bar for Built-In and Drop-In Heated Wells
HWBGM12BAR	12" Pan Support Bar for Drop-In Modular/Ganged Models
HWBGM20BAR	20" Pan Support Bar for Drop-In Modular/Ganged Models



HWB-2-7Q
(shown with two 7QT-PAN and 7QT-LID-1)

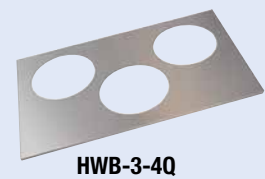
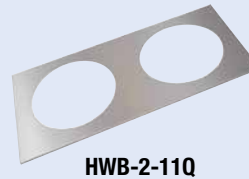
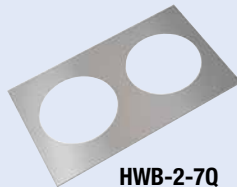

MOUNTING KITS – VALVES

Necessary at your Well Installation –

HWB-FUL-MNT	Mounting Kit for Combustible Countertops for HWB-FUL Series only
HWB-43-MNT	Mounting Kit for Combustible Countertops for HWB-43 Model only
HWB-4Q-MNT	Mounting Kit for Combustible Countertops for HWB-4Q Series only
HWB-7Q-MNT	Mounting Kit for Combustible Countertops for HWB-7Q Series only
HWB-11Q-MNT	Mounting Kit for Combustible Countertops for HWB-11Q Series only
HWB-MNT-REC	Kit allows mounting to thick countertops – 8 Brackets (HWBI & Rectangular HWB Heated Wells only)
HWB-MNT-RND	Kit allows mounting to thick countertops – 4 Brackets (Round Heated Wells only)

External Manifold includes Individual Ball Valve for each Well (not available for the Slim Models) –

HWBI2MANIF	2-Pan Accessory
HWBI3MANIF	3-Pan Accessory
HWBI4MANIF	4-Pan Accessory
HWBI5MANIF	5-Pan Accessory
HWBI6MANIF	6-Pan Accessory

Necessary at your Well Installation –

BALLVALVE3/4	High Temperature 3/4" NPT Ball Valve for units with Individual Drain(s) and no Manifold
BALLVALVE1INCH	High Temperature 1" NPT Ball Valve for units with Manifold Drain (Ganged Heated Wells only)
GATEVALVE3/4IN	High Temperature 3/4" NPT Gate Valve for units with Individual Drain(s) and no Manifold
GATEVALVE1INCH	High Temperature 1" NPT Gate Valve for units with Manifold Drain (Ganged Heated Wells only)
HWB-RDH	Heated Well Remote Handle for 3/4" drains only (requires a Ball or Gate Valve)

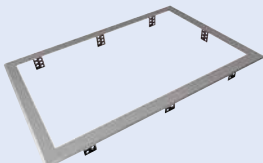

HWB-FUL-MNT
Choose the appropriate kit for HWB-FUL, HWB-43 or HWB-4Q, -7Q, -11Q series

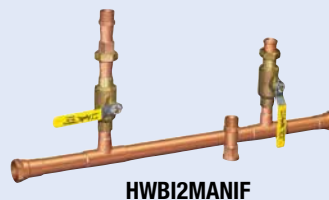



HCWBI-3DA with accessory food pans

Paint Chip Sample Colors

DESIGNER COLORS



Warm Red



Black

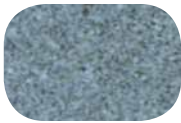

Gray Granite



White Granite



Navy Blue



Hunter Green



Antique Copper

Colors are a representation and may not exactly match our colors. Consult factory for possible color matching options on these colors. Non-standard colors are non-returnable.

To order a Hatco Paint Chip & Stone Sample Colors Sheet, visit www.hatcocorp.com / Order Literature / Sales Literature / Sell Sheets.



Scan with web-enabled
mobile device to visit
www.hatcocorp.com



Hatco Corporation

P.O. Box 340500 | Milwaukee WI 53234-0500 USA
800-558-0607 | 414-671-6350 | Fax: 800-543-7521
www.hatcocorp.com | equipsales@hatcocorp.com